

PROGRAMMING MANUAL

DIGITAL STORAGE OSCILLOSCOPE DCS-1000B SERIES



■ **About a trademark, a registered trademark**

A company name and the brand name mentioned in this instruction manual are the trademark or the registered trademark of each company or group in each country and region.

■ **About this instruction manual**

When copying the part or all of contents of this instruction manual, seek the copyright holder.

In addition, the specifications of the product and the contents of this instruction manual are subject to change without notice for improvement. The latest manuals are posted on our website (<https://www.texio.co.jp/>).

For the purpose of considering the environment and reducing waste, we are progressively eliminating the paper or CD manuals attached to our products.

Contents

USING THE PRODUCT SAFELY.....	I - V
1. INTERFACE OVERVIEW	1
1-1. Front Panel Overview	1
1-2. Interface Configuration	2
2. COMMAND OVERVIEW	9
2-1. Command Syntax	9
3. COMMAND DETAILS.....	10
3-1. Common Commands.....	11
3-2. Acquisition Commands.....	16
3-3. Autoscale Commands	22
3-4. Vertical Commands.....	22
3-5. Math Commands.....	27
3-6. Cursor Commands	34
3-7. Display Commands	42
3-8. Hardcopy Commands	45
3-9. Measure Commands	48
3-10. Measurement Commands	68
3-11. Reference Commands.....	74
3-12. Run Command.....	76
3-13. Timebase Commands.....	77
3-14. Trigger Commands	79
3-15. System Commands	110
3-16. Save/Recall Commands	111
3-17. Ethernet Commands	115
3-18. Bus Decode Commands	116
3-19. Mark Commands.....	128
3-20. Search Commands.....	129
3-21. Label Commands	156
3-22. Segment Commands	160
3-23. DVM Commands	166
3-24. Go_NoGo Commands	168
3-25. Data Logging Commands	173
3-26. Remote DiskCommands	175
4. APPENDX	177
4-1. Error messages	177

1. INTERFACE OVERVIEW

This manual describes how to use the remote command functionality and lists the command details. The Overview chapter describes how to configure the USB remote control interface and Ethernet interface.

1-1. Front Panel Overview

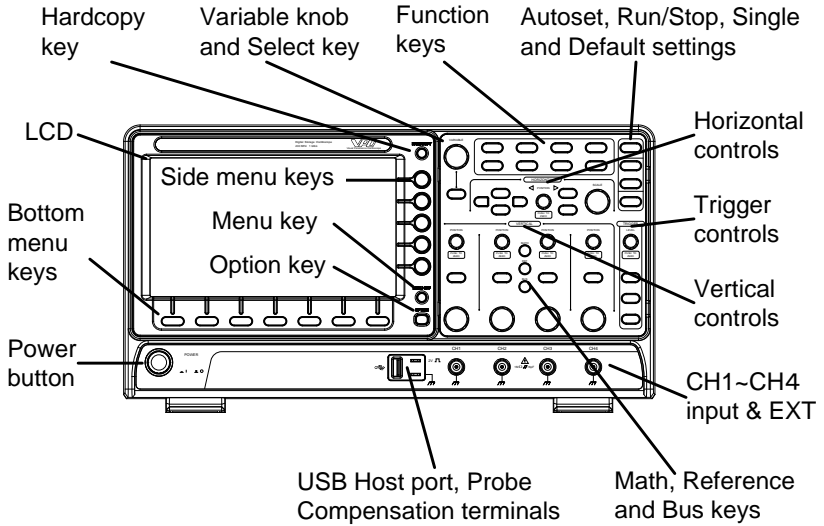

1-2. Interface Configuration
 1-2-1. Configure USB Interface

USB Configuration	PC side connector	Type A, host
	DCS-1000B side connector	Type B, device
	Speed	1.1/2.0
	USB Class	USB-CDC
	OS	Windows7 or higher (32bit/64bit)
	USB Driver	TEXIO_CDC*.inf

Panel Operation	<ol style="list-style-type: none"> 1. Press the Utility key. 2. Press I/O from the bottom menu. 3. Press <i>USB Device Port</i> from the side menu and select <i>Computer</i>. 4. Connect the USB cable to the rear panel device port. 5. When the PC asks for the USB driver or 'Unknown device' listed in Device Manager, install TEXIO-CDC*.inf. 6. If the computer can not recognize the new hardware due to the security, please go to update the driver from the "Other devices" in the Device Manager. 	
-----------------	---	---



Note You must have administrator account to install driver.

1-2-2. Configure the Ethernet Interface

Ethernet Configuration	MAC Address	Domain Name
	Instrument Name	DNS IP Address
	User Password	Gateway IP Address
	Instrument IP Address	Subnet Mask

Background The Ethernet interface is used for remote control using a socket server connection. For details, please see the Socket Server section on page 4.

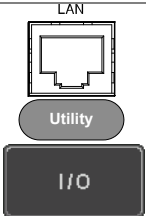
Panel Operation	<ol style="list-style-type: none"> 1. Connect the Ethernet cable to the LAN port on the rear panel. 2. Press the <i>Utility</i> key. 3. Press I/O from the bottom menu. 	
-----------------	--	---

- Press *Ethernet* from the side menu.



- Set *DHCP/BOOTP* to *On* or *Off* from the side menu.

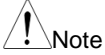

Note

IP addresses will automatically be assigned with DHCP/BOOTP set to on. For Static IP Addresses, DHCP/BOOTP should be set to off.

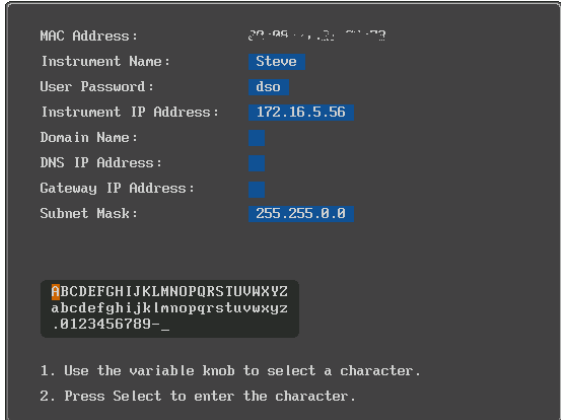

- Use the *Up* and *Down* arrows on the side menu to navigate to each Ethernet configuration item.

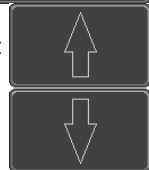

Items MAC Address, Instrument Name, User Password, Instrument IP Address, Domain Name, DNS IP Address, Gateway IP Address, Subnet Mask
 Note: HTTP Port is fixed at 80(Disable).

- Use the *Variable* knob to highlight a character and use the *Select* key to choose a character.

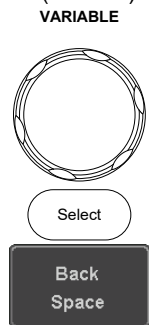

Press *Backspace* to delete a character.

Press *Save Now* to save the configuration. Complete will be displayed when successful.



1-2-3. Configure Socket Server

The DCS-1000B supports socket server functionality for direct and full duplex communication with a client PC or device over LAN. By default, the Socket Server is off.

Configure Socket Server 1. Configure the IP address for the DCS-1000B. Page 2

2. Press the *Utility* key.



3. Press *I/O* from the bottom menu.



4. Press *Socket Server* from the side menu.

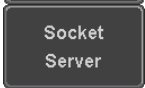

5. Press *Select Port* and choose the port number with the Variable knob.

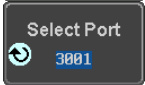

Range 1024-65535

6. Press *Set Port* to confirm the port number.

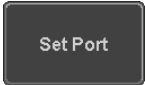

7. The Current Port icon will update to the new port number.



8. Press *Server* and turn the socket server On.

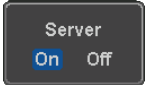

1-2-4. USB Functionality Check

Terminal Application

Invoke a terminal application such as PuTTY or RealTerm. For USB, set the COM port, baud rate, stop bit, data bit, and parity accordingly. To check the COM port number and associated port settings, see the Device Manager in the PC. For Windows:
Control panel → *Hardware and Sound* → *Device Manager*

Example: Configuring RealTerm:

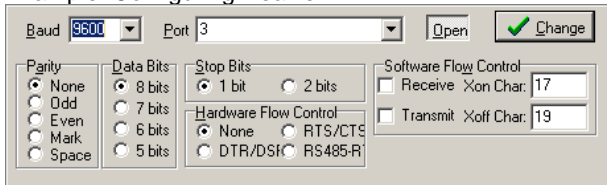

Functionality Check

Key in this query command via the terminal application.
*idn?

This should return the Manufacturer, Model number, Serial number, and Firmware version in the following format.

TEXIO,DCS-1102B,PXXXXXX,V1.00

1-2-5. Socket Server Functionality Check

NI Measurement and Automation Explorer

To test the socket server functionality, National Instruments MAX (Measurement and Automation Explorer) can be used. This program is available on the NI website, www.ni.com.

The following display and operation will differ depending on the version of MAX, Please use in accordance with the display for your MAX.

Operation

1. Configure the IP address for the DCS- 1000B. Page 2

2. Configure the socket port.

Page 4

3. Start the NI Measurement and Automation Explorer (MAX) program. Using Windows, press:



Start>All Programs>National Instruments>Measurement & Automation



4. From the Configuration panel access;
My System>Devices and Interfaces>Network Devices

5. Right click *Network Devices* and select *Create New Visa TCP/IP Resource...*

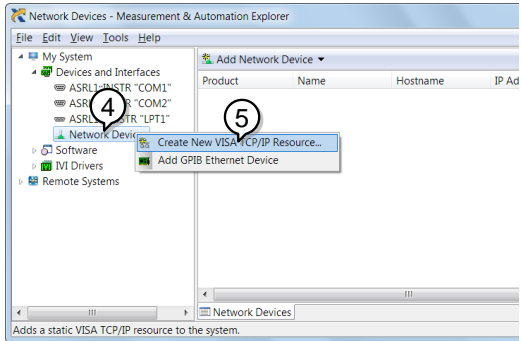

6. Select *Manual Entry of Raw Socket* from the popup window.
7. Click *Next*.

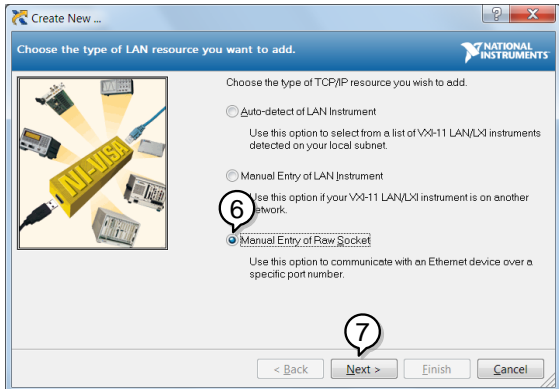

8. Enter the IP address and socket port number of the DCS-1000B.
9. Click *Validate*.
10. A popup will appear to tell you if a VISA socket session was successfully created.
11. Click *Next*.

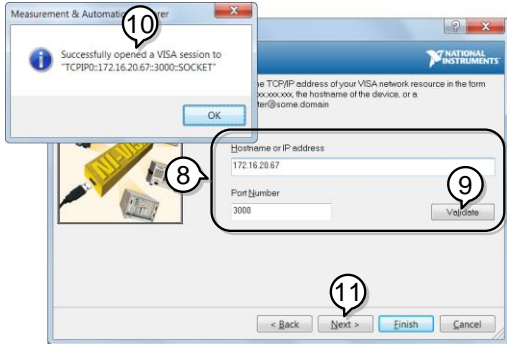

12. Choose an alias for the socket connection if you like.
13. Click *Finish* to finish the configuration.



14. The DCS-1000B will now appear under Network Devices in the Configuration Panel.
15. Click the *Open Visa Test Panel* to send a remote command to the DCS-1000B.

Functionality
Check

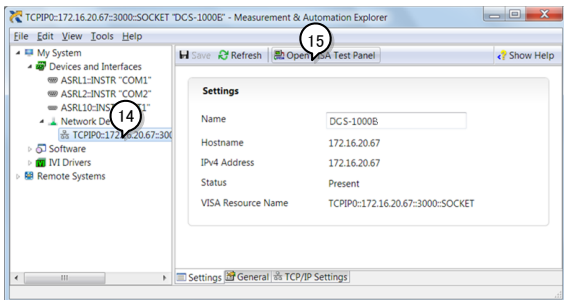

16. Click on the *Configuration* icon.
17. Select the *I/O Settings* tab.
18. Mark the *Enable Termination Character* checkbox. Make sure the termination character is a line feed (/n, value: xA).
19. Click *Apply Changes*.

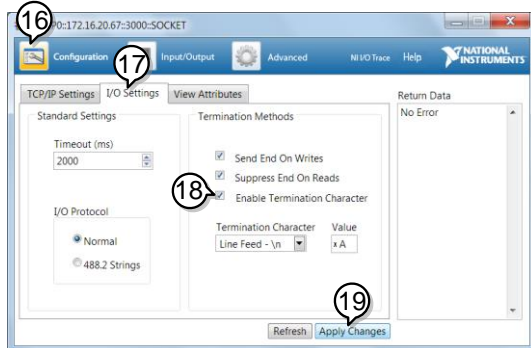

20. Click the *Input/Output* icon.
21. Make sure the **IDN?* query is selected in the *Select or Enter Command* drop box.
22. Click on *Query*.
23. The manufacturer, model number, serial number and firmware version will be displayed in the buffer. For example:
TEXIO,DCS-1102B,PXXXXXX,V1.00

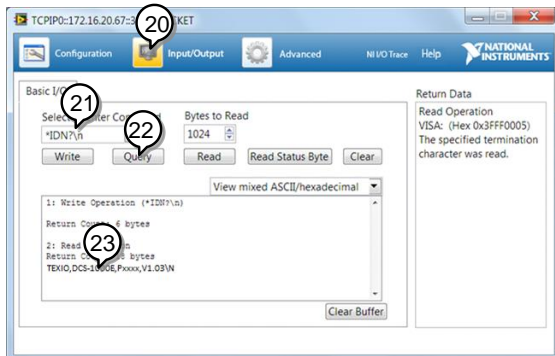

2. COMMAND OVERVIEW

The Command overview chapter lists all DCS-1000B commands in functional order as well as alphabetical order. The command syntax section shows you the basic syntax rules you have to apply when using commands.

2-1. Command Syntax

Compatible standard	<ul style="list-style-type: none"> • USB CDC_ACM compatible • SCPI, 1994 (partially compatible)
---------------------	---

Command forms	Commands and queries have two different forms, long and short. The command syntax is written with the short form of the command in capitals and the remainder (long form) in lower case.
---------------	--

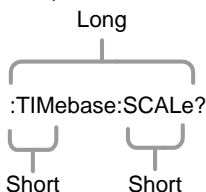

The commands can be written in capitals or lower-case, just so long as the short or long forms are complete. An incomplete command will not be recognized. Below are examples of correctly written commands.

LONG :TiMebase:SCALe? :TiMEBASE:SCALE?
:timebase:scale?

SHORT :TiM:SCAL? :TiM:SCAL?

Command format	:TiMebase:SCALe <NR3>LF	1: command header
		2: single space
		3: parameter
		4: message terminator

Parameter	Type	Description	Example
	<Boolean>	boolean logic	0, 1
	<NR1>	Integers	0, 1, 2, 3
	<NR2>	floating point	0.1, 3.14, 8.5
	<NR3>	floating point with an exponent	4.5e-1, 8.25e+1
	<NRf>	any of NR1, 2, 3	1, 1.5, 4.5e-1

Message terminator	LF	line feed code
--------------------	----	----------------

Note Commands are non-case sensitive.

3. COMMAND DETAILS

The Command details chapter shows the detailed syntax, equivalent panel operation, and example for each command.

3-1. Common Commands	11
3-2. Acquisition Commands	16
3-3. Autoscale Commands	22
3-4. Vertical Commands	22
3-5. Math Commands	27
3-6. Cursor Commands	34
3-7. Display Commands	42
3-8. Hardcopy Commands	45
3-9. Measure Commands	48
3-10. Measurement Commands	68
3-11. Reference Commands	74
3-12. Run Command	76
3-13. Timebase Commands	77
3-14. Trigger Commands	79
3-15. System Commands	110
3-16. Save/Recall Commands	111
3-17. Ethernet Commands	115
3-18. Bus Decode Commands	116
3-19. Mark Commands	128
3-20. Search Commands	129
3-21. Label Commands	156
3-22. Segment Commands	160
3-23. DVM Commands	166
3-24. Go_NoGo Commands	168
3-25. Data Logging Commands	173
3-26. Remote DiskCommands	175

Note: Depending on the command that you use will require optional app or optional functions of DCS-1000B. Please check the function by the panel operation to determine whether it is working.

3-1. Common Commands

3-1-1. *IDN?	11
3-1-2. *LRN?	11
3-1-3. *SAV	11
3-1-4. *RCL	12
3-1-5. *RST	12
3-1-6. *CLS	12
3-1-7. *ESE	12
3-1-8. *ESR	13
3-1-9. *OPC	13
3-1-10. *SRE	14
3-1-11. *STB	15

3-1-1. *IDN?

→ Query

Description	Returns the manufacturer, model, serial number and version number of the unit.
Syntax	*IDN?
Example	*IDN? TEXIO, DCS-1104B,P930116,V0.82b

3-1-2. *LRN?

→ Query

Description	Returns the oscilloscope settings as a data string.
Syntax	*LRN?
Example	*LRN? :DISPlay:WAVEform VECTOR;PERSistence 2.400E-01;INTensity:WAVEform 50;INTensity:GRATICule 50;GRATICule FULL;:CHANnel CH1:DISPlay ON;BWLimit . . . 1.000e+00;PROBe:TYPe VOLTAGE;SCALe 5.000E-02;IMPedance 1E+6;EXPand GROUND;:CHANnel OFF

3-1-3. *SAV

Set →

Description	Saves the current panel settings to the selected memory number.
Syntax	*SAV {1 2 3 ... 20}
Example	*SAV 1 Saves the current panel settings to Set 1

3-1-4. *RCL

Set →

Description	Recalls a set of panel settings.
Syntax	*RCL {1 2 3 ... 20}
Example	*RCL 1 Recalls the selected setup from Set 1.

3-1-5. *RST

Set →

Description	Resets the DCS-1000B (recalls the default panel settings).
Syntax	*RST

3-1-6. *CLS

Set →

Description	Clears the error queue.
Syntax	*CLS

3-1-7. *ESE

Set →

→ Query

Description	Sets or queries the Standard Event Status Enable register.			
Syntax	*ESE <NR1>			
Query Syntax	*ESE?			
Return parameter	<NR1> 0~255			
Bit Weight	Bit#	Weight	Event	Description
	0	1	OPC	Operation Complete Bit
	1	2	RQC	Not used
	2	4	QYE	Query Error
	3	8	DDE	Device Error
	4	16	EXE	Execution Error
	5	32	CME	Command Error
	6	64	URQ	User Request
	7	128	PON	Power On
Example	*ESE? >4 Indicates that there is a query error.			

3-1-8. *ESR

→ Query

Description	Queries the Standard Event Status (Event) register. The Event Status register is cleared after it is read.			
Query Syntax	*ESR?			
Return parameter	<NR1> 0~255			
Bit Weight	Bit#	Weight	Event	Description
	0	1	OPC	Operation Complete Bit
	1	2	RQC	Not used
	2	4	QYE	Query Error
	3	8	DDE	Device Error
	4	16	EXE	Execution Error
	5	32	CME	Command Error
	6	64	URQ	User Request
	7	128	PON	Power On
Example	*ESR? >4 Indicates that there is a query error.			

3-1-9. *OPC

Set →

→ Query

Description	The *OPC command sets the OPC bit (bit0) of the Standard Event Status Register when all current commands have been processed. The *OPC? Query returns 1 when all the outstanding commands have completed.		
Syntax	*OPC		
Query Syntax	*OPC?		
Return parameter	1	Returns 1 when all the outstanding commands have completed.	

3-1-10. *SRE

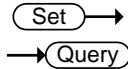

Description	Sets or queries the Service Request Enable register. The Service Request Enable register determines which registers of the Status Byte register are able to generate service requests.			
Syntax	*SRE <NR1>			
Query Syntax	*SRE?			
Parameter/ Return parameter	<NR1> 0~255			
Bit Weight	Bit#	Weight	Event	Description
	0	1		Not used
	1	2		Not used
	2	4		Not used
	3	8		Not used
	4	16	MAV	Message Available Bit
	5	32	ESB	Event Status Bit
	6	64	MSS	Master Summary Bit
	6	64	RQS	Request Service Bit
	7	128		Not used
Example	*SRE? >48 Indicates that the MAVB and ESB bit are both set.			

3-1-11. *STB

→ Query

Description	Queries the bit sum of the Status Byte register with MSS (Master summary Status) replacing the RQS bit (bit 6).			
Query Syntax	*STB?			
Return parameter	<NR1> 0 ~ 255			
Bit Weight	Bit#	Weight	Event	Description
	0	1		Not used
	1	2		Not used
	2	4		Not used
	3	8		Not used
	4	16	MAV	Message Available Bit
	5	32	ESB	Event Status Bit
	6	64	MSS	Master Summary Bit
	6	64	RQS	Request Service Bit
	7	128		Not used
Example	*STB? >16 Indicates that the MAV bit is set.			

3-2. Acquisition Commands

3-2-1. :ACquire:AVERage.....	16
3-2-2. :ACquire:MODE.....	16
3-2-3. :ACquire<X>:MEMory?	17
3-2-4. :ACquire:FILTer:SOURce.....	18
3-2-5. :ACquire:FILTer.....	19
3-2-6. :ACquire:FILTer:FREQuency	19
3-2-7. :ACquire:FILTer:FREQuency:UPPER	19
3-2-8. :ACquire:FILTer:FREQuency:LOWER.....	20
3-2-9. :ACquire:FILTer:TYPe.....	20
3-2-10. :ACquire:FILTer:TRACking.....	20
3-2-11. :ACquire<X>:STATe?.....	21
3-2-12. :ACquire:RECOrdlength	21
3-2-13. :HEADer.....	21

3-2-1. :ACquire:AVERage

Set →

→ Query

Description	Selects or returns the number of waveform acquisitions that are averaged in the average acquisition mode.
Syntax	:ACquire:AVERage {<NR1> ?}
Related Commands	:ACquire:MODE
Parameter	<NR1> 2, 4, 8, 16, 32, 64, 128, 256
Note	Before using this command, select the average acquisition mode. See the example below.
Example	:ACquire:MODE AVERage :ACquire:AVERage 2 Selects the average acquisition mode, and sets the average number to 2.

3-2-2. :ACquire:MODE

Set →

→ Query

Description	Selects or returns the acquisition mode.
Syntax	:ACquire:MODE {SAMPLE PDEtect AVERage ?}
Related Commands	:ACquire:AVERage
Parameter	SAMPLE Sample mode sampling PDEtect Peak detect sampling AVERage Average sampling mode
Example	:ACquire:MODE PDEtect Sets the sampling mode to peak detection.

3-2-3. :ACquire<X>:MEMory?

→ Query

Description	Returns the data in acquisition memory for the selected channel as a header + raw data.
Syntax	:ACquire<X>:MEMory?
Related Commands	ACquire:RECOlength :HEADER
Parameter	<X> Channel number (1 to 4)
Return parameter	Returns acquisition settings followed by raw waveform block data. <string> Returns the acquisition settings for the selected channel. Format: parameter(1),setting(1);parameter(2),setting(2)...parameter(n),setting(n);Waveform Data; <waveform block data> Header followed by the raw waveform data. Format: Header: The header (in ASCII) encodes the number of bytes for the header followed by the number of data points in bytes for the raw data.

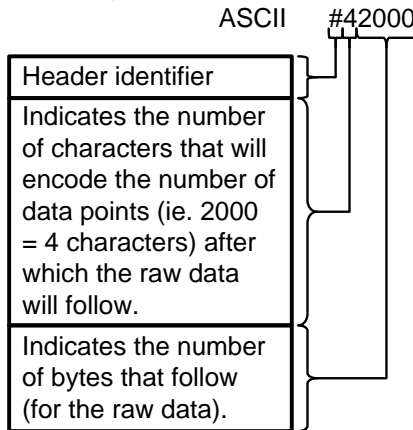

Raw Data:

Each two bytes (in hex) encodes the vertical data of a data point. The data is signed hex data (2's complement, -32768 ~ 32767).

Waveform Raw Data Example:

Header raw data.....

Hex:

23 34 32 30 30 30 00 1C 00 1B 00 1A 00 1A 00 1B
.....

ASCII/Decimal:

#42000 28 27 26 26 27.....

The actual value of a data point can be calculated with the following formula:

(Decimal value of hex data/AD Factor) * vertical scale.

Note: AD Factor is fixed as 25. The vertical scale is returned with the acquisition settings that precede the raw data.

For example if the raw data for a point is 001C (=28 decimal) then,
 $(28/25) \times 0.5 = 0.56V$

Example

:ACquire1:MEMory?

Format,2.0E;Memory Length,10000;IntpDistance,0;

Trigger Address,4999;Trigger Level,1.160E+01;

Source,CH1;Vertical Units,V;Vertical Units

Div,0;Vertical Units Extend Div,15;Label,ACK ;Probe

Type,0;Probe Ratio,1.000e+01;Vertical

Scale,5.000e+00;Vertical Position,-

1.100e+01;Horizontal Units,S;Horizontal Scale,5.000E-

04;Horizontal Position,0.000E+00; Horizontal

Mode,Main;SincET Mode,Real Time;Sampling

Period,5.000e-07;Horizontal Old Scale,5.000E-

04;Horizontal Old Position,0.000E+00;

Firmware,V0.99b8;Time,02-Oct-14 17:00:43;

Waveform Data; #520000.....follows waveform
block data in hex

Note:

On Windows 10, data loss may occur due to insufficient CPU power. Adjust the transfer timing with the ":USBDelay" command and use as fast a PC as possible.

3-2-4. :ACquire:FILTer:SOURce

Set →

→ Query

Description	Returns the source of the filter.
Syntax	:ACquire:FILTer:SOURce {CH1 CH2 CH3 CH4 ?}
Parameter/ Return parameter	CH1 ~ CH4 Source channel
Example	:ACquire:FILTer:SOURce? CH1 Sets the filter source to CH1.

3-2-5. :ACquire:FILTer

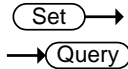

Description	Turns the filter on/off or queries its status.	
Syntax	:ACquire:FILTer {OFF ON ?}	
Parameter/Return parameter	OFF	Turns the digital filter off.
	ON	Turns the digital filter on.
Example	:ACquire:FILTer OFF Turns the digital filter off.	

3-2-6. :ACquire:FILTer:FREquency

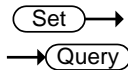

Description	Sets or queries the filter frequency.	
Syntax	:ACquire:FILTer:FREquency {DEfault <NRf> ?}	
Parameter/ Return parameter	DEfault	Sets the filter frequency to the default.
	<NRf>	Manually sets the filter frequency. (1Hz ~ 500MHz)
Example	:ACquire:FILTer:FREquency 1 Sets the filter frequency to 1Hz.	

3-2-7. :ACquire:FILTer:FREquency:UPPER

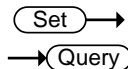

Parameter	DEfault	Sets the frequency to default.
	<NRf>	Sets the frequency to user. (Range:1Hz~500MHz)
Example	:ACquire:FILTer:FREquency:UPPER 4.95e+05 :ACquire:FILTer:FREquency:UPPER? 4.950000e+05	

3-2-8. :ACQUIRE:FILTER:FREQUENCY:LOWER

Set →

→ Query

Description	Sets or returns the filter lower frequency.	
Syntax	:ACQUIRE:FILTER:FREQUENCY:LOWER {DEFAULT} :ACQUIRE:FILTER:FREQUENCY:LOWER <NRf> :ACQUIRE:FILTER:FREQUENCY:LOWER?	
Parameter	DEFAULT	Sets the frequency to default.
	<NRf>	Sets the frequency to user. (Range: 1Hz~500MHz)
Example	:ACQUIRE:FILTER:FREQUENCY:LOWER 1.25e+05 :ACQUIRE:FILTER:FREQUENCY:LOWER? 1.250000e+05	

3-2-9. :ACQUIRE:FILTER:TYPE

Set →

→ Query

Description	Sets or returns the filter type.	
Syntax	:ACQUIRE:FILTER:TRACKING {LOWPass HIGHPass BANDPass} :ACQUIRE:FILTER:TYPE?	
Parameter	LOWPass	Lowpass Type.
	HIGHPass	Highpass Type.
	BANDPass	bandpass Type.
Example	:ACQUIRE:FILTER:TYPE? >LOWPass Returns low pass type as present filter type	

3-2-10. :ACQUIRE:FILTER:TRACKING

Set →

→ Query

Description	Turns filter tracking on/off or queries its state.	
Syntax	:ACQUIRE:FILTER:TRACKING {ON OFF ?}	
Parameter/ Return parameter	OFF	Tracking off
	ON	Tracking on
Example	:ACQUIRE:FILTER:TRACKING ON Turns filter tracking on.	

3-2-11. :ACquire<X>:STATe?

→ Query

Description	Returns the status of waveform data.
Syntax	:ACquire<X>:STATe?
Parameter	<X> Channel number (1 to 4)
Return parameter	0 Raw data is not ready 1 Raw data is ready
Example	:ACquire1:STATe? 0 Returns 0. The channel 1's raw data is not ready. Note: If the oscilloscope changes the acquisition status from STOP to RUN, the status will be reset as zero.

3-2-12. :ACquire:RECOrdlength

Set →

→ Query

Description	Sets or queries the record length. Please see the user manual for full details.
Syntax	:ACquire:RECOrdlength {<NRf> ?}
Parameter/Return parameter	<NRf> Record length. Settable record length: (1e+3 1e+4 1e+5 1e+6 1e+7)
Example	:ACquire:RECOrdlength 1e+3 Sets the record length to 1000 points.

3-2-13. :HEADer

Set →

→ Query

Description	Configures whether the :ACquire:MEM or :ACquire:LMEM return data will contain header information or not. It is set to ON by default.
Syntax	:HEADer {OFF ON ?}
Related Commands	:ACquire<X>:MEMory?
Parameter	<X> Channel number (1 to 4) ON Add header information. OFF Don't add header information.
Return parameter	Returns the configuration (ON, OFF) for the selected channel.
Example	:HEADer ON

3-3. Autoscale Commands

3-3-1. :AUTOSet

Set →

Description	Runs the Autoset function to automatically configure the horizontal scale, vertical scale, and trigger according to the input signal.
Syntax	:AUTOSet

3-3-2. :AUTORSET:MODE

Set →

→ Query

Description	Sets the Autoset mode or queries its state.
Syntax	:AUTORSET:MODE {FITScreen ACPriority ?}
Related Commands	:AUTOSet
Parameter/Return parameter	FITScreen Fit Screen mode ACPriority AC priority mode
Example	:AUTORSET? FITSCREEN

3-4. Vertical Commands

3-4-1. :CHANnel<X>:BWLimit	23
3-4-2. :CHANnel<X>:COUPLing.....	23
3-4-3. :CHANnel<X>:DESKew	23
3-4-4. :CHANnel<X>:DISPlay.....	24
3-4-5. :CHANnel<X>:EXPand	24
3-4-6. :CHANnel<X>:IMPedance?.....	24
3-4-7. :CHANnel<X>:INVert	25
3-4-8. :CHANnel<X>:POSition	25
3-4-9. :CHANnel<X>:PROBe:RATio.....	26
3-4-10. :CHANnel<X>:PROBe:TYPE.....	26
3-4-11. :CHANnel<X>:SCALE	26

3-4-1. :CHANnel<X>:BWLimit

Set →

→ Query

Description	Sets or returns the bandwidth limit on/off.	
Syntax	:CHANnel<X>:BWLimit {FULL <NR3> ?}	
Parameter	<X>	Channel 1,2,3,4
	FULL	Full bandwidth
	<NR3>	Sets the bandwidth limit to a pre-defined bandwidth. 20E+6: 20MHz
Return Parameter	<NR3>	Returns the bandwidth.
	Full	Full bandwidth
Example	:CHANnel1:BWLimit 2.000E+07 Sets the channel 1 bandwidth 20MHz	

3-4-2. :CHANnel<X>:COUPling

Set →

→ Query

Description	Selects or returns the coupling mode.	
Syntax	CHANnel<X>:COUPling {AC DC GND ?}	
Parameter	<X>	Channel 1,2,3,4
	AC	AC coupling
	DC	DC coupling
	GND	Ground coupling
Return parameter	Returns the coupling mode.	
Example	:CHANnel1:COUPling DC Sets the coupling to DC for Channel 1.	

3-4-3. :CHANnel<X>:DESKew

Set →

→ Query

Description	Sets the deskew time in seconds.	
Syntax	:CHANnel<X>:DESKew { <NR3> ? }	
Parameter	<X>	Channel 1,2,3,4
	<NR3>	Deskew time: -5.00E -11 to 5.00E-11 -50ns to 50 ns.
Return parameter	<NR3>	Returns the deskew time.
Example	:CHANnel1:DESKew 1.300E-9 Sets the deskew time to 1.3 nano seconds.	

3-4-4. :CHANnel<X>:DISPlay

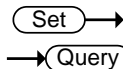

Description	Turns a channel on/off or returns its status.	
Syntax	:CHANnel<X>:DISPlay {OFF ON ?}	
Parameter	<X>	Channel 1,2,3,4
	OFF	Channel off
	ON	Channel on
Return Parameter	ON	Channel is on.
	OFF	Channel is off
Example	:CHANnel1:DISPlay ON Turns on Channel 1	

3-4-5. :CHANnel<X>:EXPand

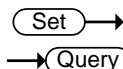

Description	Sets Expand By Ground or Expand By Center for a channel or queries its status.	
Syntax	:CHANnel<X>:EXPand {GND CENTER ?}	
Parameter	<X>	Channel 1,2,3,4
	GND	Ground
	CENTER	Center
Return parameter	GND	Expand By Ground
	CENTER	Expand By Center
Example	:CHANnel1:EXPand GND Sets Channel 1 to Expand By Ground.	

3-4-6. :CHANnel<X>:IMPedance?

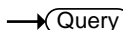

Description	Returns the impedance of the oscilloscope.	
Syntax	:CHANnel<X>:IMPedance?	
Parameter	<x>	Channel
	1/2/3/4	CH1/2/3/4
Return parameter	<NR3>	Returns the impedance value.
Example	:CHANnel1:IMPedance? 1.000000E+06 The impedance is 1M ohms.	

3-4-7. :CHANnel<X>:INVert

Set →

→ Query

Description	Inverts a channel or returns its status.	
Syntax	:CHANnel<X>:INVert {OFF ON ?}	
Parameter	<X>	Channel 1, 2, 3, 4
	OFF	Invert off
	ON	Invert on
Return parameter	ON	Invert on
	OFF	Invert off
Example	:CHANnel1:INVert ON Inverts Channel 1	

3-4-8. :CHANnel<X>:POSition

Set →

→ Query

Description	Sets or returns the position level for a channel.	
Note	The vertical position will only be set to closest allowed value. The position level range depends on the vertical scale. The scale must first be set before the position can be set.	
Syntax	:CHANnel<X>:POSition { <NRf> ? }	
Parameter	<X>	Channel 1, 2, 3, 4
	<NRf>	Position. Range depends on the vertical scale.
Return parameter	<NR3>	Returns the position value.
Example 1	:CHANnel1:POSition 2.4E-3 Sets the Channel 1 position to 2.4mV/mA	
Example 2	:CHANnel1:POSition? 2.4E-3 Returns 2.4mV as the vertical position.	

3-4-9. :CHANnel<X>:PROBE:RATio

Set →

→ Query

Description	Sets or returns the probe attenuation factor.	
Syntax	:CHANnel<X>:PROBE:RATio { <NRf> ? }	
Related Commands	:CHANnel<X>:PROBE:TYPE	
Parameter	<X>	Channel 1, 2, 3, 4
	<NRf>	Probe attenuation factor.
Return parameter	<NR3>	Returns the probe factor.
Example	:CHANnel1:PROBE:RATio 1.00E+0 Sets the Channel 1 probe attenuation factor to 1x	

3-4-10. :CHANnel<X>:PROBE:TYPE

Set →

→ Query

Description	Sets or returns the probe type (voltage/current).	
Syntax	:CHANnel<X>:PROBE:TYPE { VOLTage CURRent ? }	
Related Commands	:CHANnel<X>:PROBE:RATio	
Parameter	<X>	Channel 1, 2, 3, 4
	VOLTage	Voltage
	CURRent	Current
Return parameter	Returns the probe type.	
Example	:CHANnel1:PROBE:TYPE VOLTage Sets the Channel 1 probe type to voltage.	

3-4-11. :CHANnel<X>:SCALE

Set →

→ Query

Description	Sets or returns the vertical scale. The scale depends on the probe attenuation factor. Note the probe attenuation factor should be set before the scale.	
Syntax	:CHANnel<X>:SCALE { <NRf> ? }	
Parameter	<X>	Channel 1, 2, 3, 4
	<NRf>	Vertical scale: 2e-3 to 1e+1 2mV to 10V (Probe x1)
Return parameter	<NR3>	Returns the vertical scale in volts or amps.
Example	:CHANnel1:SCALE 2.00E-2 Sets the Channel 1 vertical scale to 20mV/div	

3-5. Math Commands

3-5-1. :MATH:DISP	27
3-5-2. :MATH:TYPe.....	27
3-5-3. :MATH:DUAL:SOURce<X>.....	28
3-5-4. :MATH:DUAL:OPERator	28
3-5-5. :MATH:DUAL:POSition	28
3-5-6. :MATH:DUAL:SCALe.....	29
3-5-7. :MATH:FFT:SOURce	29
3-5-8. :MATH:FFT:MAG	29
3-5-9. :MATH:FFT:WINDow	30
3-5-10. :MATH:FFT:POSition	30
3-5-11. :MATH:FFT:SCALe.....	30
3-5-12. :MATH:FFT:HORIZontal:SCALe	31
3-5-13. :MATH:FFT:HORIZontal:POSition	31
3-5-14. :MATH:DEFine.....	32
3-5-15. :MATHVAR?	32
3-5-16. :MATHVAR:VAR<X>.....	33
3-5-17. :MATH:ADVanced:POSition.....	33
3-5-18. :MATH:ADVanced:SCALe.....	33

3-5-1. :MATH:DISP

Set →

→ Query

Description	Turns the math display on or off on the screen.
Syntax	:MATH:DISP {OFF ON ?}
Parameter/ Return parameter	OFF Math is not displayed on screen ON Math is displayed on screen
Example	:MATH:DISP OFF Math is off.

3-5-2. :MATH:TYPe

Set →

→ Query

Description	Queries or sets the Math type to FFT, Advanced Math or to dual channel math operations
Syntax	:MATH:TYPe { DUAL ADVanced FFT ? }
Related Commands	:MATH:DISP
Parameter	DUAL Dual channel operations ADVanced Advanced math operations FFT FFT operations
Return parameter	Returns the math type.
Example	:MATH:TYPe DUAL Sets the Math type to dual channel math operation.

3-5-3. :MATH:DUAL:SOURce<X>

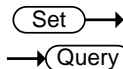

Description	Sets the dual math source for source 1 or 2.	
Syntax	:MATH:DUAL:SOURce<X> { CH1 CH2 CH3 CH4 REF1 REF2 REF3 REF4 ? }	
Parameter	<X>	Source number 1 or 2
	CH1~4	Channel 1 to 4
	REF1~4	Reference waveforms 1 to 4
Return parameter	Returns the source for the source 1 or 2.	
Example	:MATH:DUAL:SOURce1 CH1 Sets source1 as channel 1.	

3-5-4. :MATH:DUAL:OPERator

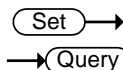

Description	Sets the math operator for dual math operations.	
Syntax	:MATH:DUAL:OPERator {PLUS MINUS MUL DIV ?}	
Parameter	PLUS	+ operator
	MINUS	- operator
	MUL	× operator
	DIV	÷ operator
Return parameter	Returns operator type.	
Example	:MATH:DUAL:OPERator PLUS Sets the math operator as plus (+).	

3-5-5. :MATH:DUAL:POSition

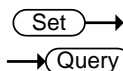

Description	Sets the vertical position of the displayed math result expressed by division.	
Syntax	:MATH:DUAL:POSition {<NRf> ? }	
Parameter	<NRf>	Vertical position
		Depends on the vertical scale (Unit/Div)
Return parameter	<NR3>	Returns the vertical position.
Example	:MATH:DUAL:POSition 1.0E+0 Sets the vertical position to 1.00 unit/div.	

3-5-6. :MATH:DUAL:SCALE

Set →

→ Query

Description	Sets the vertical scale of the displayed math result.	
Syntax	:MATH:DUAL:SCALE {<NRf> ?}	
Parameter	<NRf>	Vertical scale
Return parameter	<NR3>	Returns the scale.
Example	:MATH:DUAL:SCALE 2.0E-3 Sets the vertical scale to 2mV/2mA.	

3-5-7. :MATH:FFT:SOURce

Set →

→ Query

Description	Sets and queries the FFT math source.	
Syntax	:MATH:FFT:SOURce { CH1 CH2 CH3 CH4 REF1 REF2 REF3 REF4 FUNCTION ? }	
Related commands	:MATH:ADVanced:EDIT:SOURce<X> :MATH:ADVanced:EDIT:OPERator	
Parameter	CH1~4	Channel 1 to 4
	REF1~4	Reference waveform 1 to 4
	FUNCTION	F(X) waveform
Return parameter	Returns the FFT source.	
Example	:MATH:FFT:SOURce CH1 Sets the FFT math source as channel 1.	

3-5-8. :MATH:FFT:MAG

Set →

→ Query

Description	Sets FFT vertical units as linear or decibels.	
Syntax	:MATH:FFT:MAG {LINEAR DB ?}	
Parameter	LINEAR	Linear units (Vrms)
	DB	Logarithmic units (dB)
Return parameter	Returns the FFT vertical units.	
Example	:MATH:FFT:MAG DB Sets FFT vertical units to dB.	

3-5-9. :MATH:FFT:WINDow

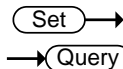

Description	Sets the windowing filter used for the FFT function.
Syntax	:MATH:FFT:WINDow {RECTangular HAMming HANning BLAckman[?]}
Parameter	RECTangular Rectangular window HAMming Hamming window HANning Hanning window BLAckman Blackman window
Return parameter	Returns the FFT window.
Example	:MATH:FFT:WINDow HAMming Sets the FFT window filter to hamming.

3-5-10. :MATH:FFT:POSition

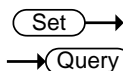

Description	Sets the vertical position of the displayed FFT result.
Syntax	MATH:FFT:POSition { <NRf> ? }
Parameter	<NRf> Vertical position: -12e+0 to +12e+0 (12 units/division to +12 units/division.)
Return parameter	<NR3> Returns the vertical position.
Example	:MATH:FFT:POSition -2e-1 Sets the FFT position to -0.2 divisions.

3-5-11. :MATH:FFT:SCALE

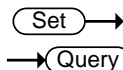

Description	Sets the vertical scale of the displayed FFT result.
Syntax	:MATH:FFT:SCALE {<NRf> ?}
Parameter	<NRf> Vertical scale: Linear: 2e-3 to 1e+ (32mV~1kV) dB: 1e+0 to 2e+1 (1~20dB)
Return parameter	<NR3> Returns vertical scale.
Example	:MATH:FFT:SCALE 1.0e+0 Sets the scale to 1dB.

3-5-12. :MATH:FFT:HORizontal:SCALe

Set →

→ Query

Description	Sets or queries the zoom scale for FFT math.
Syntax	:MATH:FFT:HORizonatal:SCALe {<NRf> ?}
Parameter	<NRf> Zoom scale: 1 to 20 times
Return parameter	<NR3> Returns zoom scale.
Example	:MATH:FFT:HORizontal:SCALe 5 Sets the zoom scale to 5X.

3-5-13. :MATH:FFT:HORizontal:POSition

Set →

→ Query

Description	Sets the horizontal position of the displayed FFT result.
Syntax	MATH:FFT:HORizontal:POSition { <NRf> ? }
Parameter	<NRf> Horizontal position: 0Hz ~ 999.9kHz
Return parameter	<NR3> Returns the vertical position.
Example	:MATH:FFT:HORizontal:POSition 6.0e5 Sets the FFT horizontal position to 600kHz.

3-5-14. :MATH:DEFine

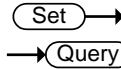

Description	Sets or queries the advanced math expression as a string.												
Syntax	:MATH:DEFine {<string> ?}												
Related	:MATH:DISP :MATH:TYPE												
Parameter	<p><string> An expression enclosed in double quotes. Note, ensure parentheses are used correctly in the expression. The expression can contain the following parts:</p> <table border="1"> <tr> <td>Source</td> <td>CH1~CH4, Ref1~Ref4</td> </tr> <tr> <td>Function</td> <td>Intg(, Diff(, log(, ln(, Exp(, Sqrt(, Abs(, Rad(, Deg(, sin(, cos(, tan(, asin(, acos(, atan(</td> </tr> <tr> <td>Variable</td> <td>VAR1, VAR2</td> </tr> <tr> <td>Operator</td> <td>+, -, *, /, (,), !, <, >, <=, >=, ==, !=, , &&</td> </tr> <tr> <td>Figure</td> <td>0, 1, 2, 3, 4, 5, 6, 7, 8, 9, ., E</td> </tr> <tr> <td>Measurement</td> <td>Pk-Pk(, Max(, Min(, Amp(, High(, Low(, Mean(, CycleMean(, RMS(, CycleRMS(, Area(, CycleArea(, ROVShoot(, FOVShoot(, Freq(, Period(, Rise(, Fall(, PosWidth(, NegWidth(, Dutycycle(, FRR(, FRF(, FFR(, FFF(, LRR(, LRF(, LFR(, LFF(, Phase(</td> </tr> </table>	Source	CH1~CH4, Ref1~Ref4	Function	Intg(, Diff(, log(, ln(, Exp(, Sqrt(, Abs(, Rad(, Deg(, sin(, cos(, tan(, asin(, acos(, atan(Variable	VAR1, VAR2	Operator	+, -, *, /, (,), !, <, >, <=, >=, ==, !=, , &&	Figure	0, 1, 2, 3, 4, 5, 6, 7, 8, 9, ., E	Measurement	Pk-Pk(, Max(, Min(, Amp(, High(, Low(, Mean(, CycleMean(, RMS(, CycleRMS(, Area(, CycleArea(, ROVShoot(, FOVShoot(, Freq(, Period(, Rise(, Fall(, PosWidth(, NegWidth(, Dutycycle(, FRR(, FRF(, FFR(, FFF(, LRR(, LRF(, LFR(, LFF(, Phase(
Source	CH1~CH4, Ref1~Ref4												
Function	Intg(, Diff(, log(, ln(, Exp(, Sqrt(, Abs(, Rad(, Deg(, sin(, cos(, tan(, asin(, acos(, atan(
Variable	VAR1, VAR2												
Operator	+, -, *, /, (,), !, <, >, <=, >=, ==, !=, , &&												
Figure	0, 1, 2, 3, 4, 5, 6, 7, 8, 9, ., E												
Measurement	Pk-Pk(, Max(, Min(, Amp(, High(, Low(, Mean(, CycleMean(, RMS(, CycleRMS(, Area(, CycleArea(, ROVShoot(, FOVShoot(, Freq(, Period(, Rise(, Fall(, PosWidth(, NegWidth(, Dutycycle(, FRR(, FRF(, FFR(, FFF(, LRR(, LRF(, LFR(, LFF(, Phase(
Return parameter	Returns the expression as a string.												
Example	:MATH:DISP ON :MATH:TYPE ADVanced :MATH:DEFine "CH1-CH2" Sets the math expression to CH1-CH2.												

3-5-15. :MATHVAR?

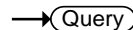

Description	Returns the value of the VAR1 and VAR2 variables.
Syntax	:MATHVAR?
Related	:MATHVAR:VAR<X>
Commands	:MATH:DEFine
Return parameter	<string> VAR1 <NR3>; VAR2 <NR3>
Example	:MATHVAR? VAR1 1.000000E+06; VAR2 1.0E+1 Returns the value of both variables.

3-5-16. :MATHVAR:VAR<X>

Set →

→ Query

Description	Sets or returns the VAR1 or VAR2 variables.	
Syntax	:MATHVAR:VAR<x> {<NRf> ?}	
Related	:MATH:DEFine	
Commands		
Parameter	<X>	1, 2 (VAR1 or VAR2)
	<NRf>	Value of VAR1/VAR2
Return parameter	<NR3>	Returns the value of VAR1/VAR2
Example	:MATHVAR:VAR1 6.0e4 Sets VAR1 to 60000.	

3-5-17. :MATH:ADVanced:POSition

Set →

→ Query

Description	Sets the vertical position of the advanced math result, expressed in unit/div.	
Syntax	:MATH:ADVanced:POSition { <NRf> ? }	
Parameter	<NRf>	Vertical position: -12e+0 to +12e+0 (12 units/division to +12 units/division.)
Return parameter	<NR3>	Returns the vertical position.
Example	:MATH:ADVanced:POSition 1.0e+0 Sets the position as 1.00 unit/div.	

3-5-18. :MATH:ADVanced:SCALE

Set →

→ Query

Description	Sets or queries the vertical scale the advanced math result.	
Syntax	:MATH:ADVanced:SCALE {<NRf> ?}	
Parameter	<NRf>	Vertical scale
Return parameter	<NR3>	Returns the vertical scale.
Example	:MATH:ADVanced:SCALE 2.0E-3 Sets the vertical scale to 2mV/S	

3-6. Cursor Commands

3-6-1. :CURSor:MODE	34
3-6-2. :CURSor:SOURce	35
3-6-3. :CURSor:HUNI.....	35
3-6-4. :CURSor:HUSE.....	35
3-6-5. :CURSor:VUNI.....	36
3-6-6. :CURSor:VUSE.....	36
3-6-7. :CURSor:DDT	36
3-6-8. :CURSor:H1Position	37
3-6-9. :CURSor:H2Position	37
3-6-10. :CURSor:HDELta	37
3-6-11. :CURSor:V1Position.....	38
3-6-12. :CURSor:V2Position.....	38
3-6-13. :CURSor:VDELta	38
3-6-14. :CURSor:XY:RECTangular:X:POSition<X>.....	39
3-6-15. :CURSor:XY:RECTangular:X:DELta	39
3-6-16. :CURSor:XY:RECTangular:Y:POSition<X>.....	39
3-6-17. :CURSor:XY:RECTangular:Y:DELta	40
3-6-18. :CURSor:XY:POLar:RADIUS:POSition<X>.....	40
3-6-19. :CURSor:XY:POLar:RADIUS:DELta.....	40
3-6-20. :CURSor:XY:POLar:THETA:POSition<X>.....	40
3-6-21. :CURSor:XY:POLar:THETA:DELta	41
3-6-22. :CURSor:XY:PRODuct:POSition<X>.....	41
3-6-23. :CURSor:XY:PRODuct:DELta	41
3-6-24. :CURSor:XY:RATio:POSition<X>.....	41
3-6-25. :CURSor:XY:RATio:DELta	42

3-6-1. :CURSor:MODE

Set →

→ Query

Description	Sets cursor mode to horizontal (H) or horizontal and vertical (HV). Note: When the cursor source is set to bus, then only the horizontal cursor is available.
Syntax	:CURSor:MODE {OFF H HV ? }
Parameter	OFF Turns the cursors off. H Turns the horizontal cursors on. HV Turns horizontal and vertical cursors on.
Return parameter	Returns the state of the cursors (H, HV, OFF).
Example	:CURSor:MODE OFF Turns the cursors off.

3-6-2. :CURSor:SOURce

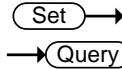

Description	Sets or queries the cursor source.	
Syntax	:CURSor:SOURce {CH1 CH2 CH3 CH4 REF1 REF2 REF3 REF4 MATH BUS1 ?}	
Parameter	CH1~CH4	Channel 1 to 4
	REF1~4	Reference waveform 1 to 4
	MATH	Math source
	BUS1	Bus source
Return parameter	Returns the cursor source.	
Example	:CURSor:SOURce CH1 Turns the cursor source as channel 1.	

3-6-3. :CURSor:HUNI

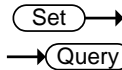

Description	Sets or queries the units for the horizontal bar cursors.	
Syntax	:CURSor:HUNI {SECOnds HERTz DEGrees PERcent ?}	
Related Commands	:CURSor:MODE	
Parameter	SECOnds	Sets the cursor units to time in seconds.
	HERTz	Sets the cursor units to frequency.
	DEGrees	Sets the cursor units to degrees.
	PERcent	Sets the cursor units to percent.
Return parameter	Returns the unit type.	
Example	:CURSor:HUNI SECOnds Sets the units to time in seconds.	

3-6-4. :CURSor:HUSE



Description	Sets the current cursor position as the phase or ratio reference for the Percent or Degrees (horizontal) cursors.	
Note	This command can only be used when :CURSor:HUNI is set to DEGrees or PERcent.	
Syntax	:CURSor:HUSE {CURRent}	
Related Commands	:CURSor:MODE :CURSor:HUNI	
Parameter	CURRent	Uses the current horizontal position
Example	:CURSor:HUSE CURRent.	

3-6-5. :CURSor:VUNI

Set →
 → Query

Description	Sets or queries the units for the vertical bar cursors.	
Syntax	:CURSor:VUNI {BASE PERcent ?}	
Related Commands	:CURSor:MODE	
Parameter	BASE	Sets the vertical cursor units the same as the scope units (V or A).
	PERcent	Sets the displayed units to percent.
Return parameter	Returns the unit type.	
Example	:CURSor:VUNI BASE Sets the units to the base units.	

3-6-6. :CURSor:VUSE

Set →

Description	Sets the current cursor position as the ratio reference for the Percent (vertical) cursors.	
Note	This command can only be used when :CURSor:VUNI is set to PERcent.	
Syntax	:CURSor:VUSE {CURRent}	
Related Commands	:CURSor:MODE :CURSor:VUNI	
Parameter	CURRent	Uses the current vertical position
Example	:CURSor:VUSE CURRent.	

3-6-7. :CURSor:DDT

→ Query

Description	Returns the deltaY/deltaT (dy/dT) readout.	
Syntax	:CURSor:DDT {?}	
Related Commands	:CURSor:MODE	
Return Parameter	<NR3>	Returns the readout in <NR3> format.
Example	:CURSor:DDT? 4.00E-05	

3-6-8. :CURSor:H1Position

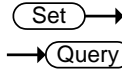

Description	Sets or returns the first horizontal cursor (H1) position.
Syntax	:CURSor:H1Position {<NRf> ?}
Related Commands	:CURSor:H2Position
Parameter	<NRf> Horizontal position
Return parameter	Returns the cursor position.
Example	:CURSor:H1Position? -1.34E-3 Returns the H1 cursor position as -1.34ms.

3-6-9. :CURSor:H2Position

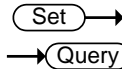

Description	Sets or returns the second horizontal cursor (H2) position.
Syntax	:CURSor:H2Position {<NRf> ?}
Related Commands	:CURSor:H1Position
Parameter	<NRf> Horizontal Position
Return parameter	Returns the cursor position.
Example	:CURSor:H2Position 1.5E-3 Sets the H2 cursor position to 1.5ms.

3-6-10. :CURSor:HDELta

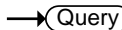

Description	Returns the delta of H1 and H2.
Syntax	:CURSor:HDELta {?}
Return Parameter	<NR3> Returns the distance between two horizontal cursors.
Example	:CURSor:HDELta? 5.0E-9 Returns the horizontal delta as 5ns.

3-6-11. :CURSor:V1Position

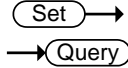

Description	Sets the first vertical cursor (V1) position.	
Syntax	:CURSor:V1Position {<NRf> ?}	
Parameter	<NRf>	Vertical position. Depends on the vertical scale.
Return parameter	<NR3>	Returns the cursor position.
Example	:CURSor:V1Position 1.6E -1 Sets the V1 cursor position to 160mA.	

3-6-12. :CURSor:V2Position

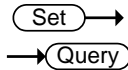

Description	Sets the first vertical cursor (V2) position.	
Syntax	:CURSor:V2Position {<NRf> ?}	
Parameter	<NRf>	Vertical position. Depends on the vertical scale.
Return parameter	<NR3>	Returns the cursor position.
Example	:CURSor:V2Position 1.1E-1 Sets the V2 cursor position to 110mA.	

3-6-13. :CURSor:VDELta



Description	Returns the delta of V1 and V2.	
Syntax	:CURSor:VDELta {?}	
Return Parameter	<NR3>	Returns the difference between two vertical cursors.
Example	:CURSor:VDELta? 4.00E+0 Returns the vertical delta as 4 volts.	

3-6-14. :CURSor:XY:RECTangular:X:POSition<X>

Set →

→ Query

Description	Sets or queries the horizontal position in XY mode for the X rectangular coordinates for cursor 1 or 2.
Syntax	:CURSor:XY:RECTangular:X:POSition<X> {NRf ?}
Parameter	<X> Cursor 1, 2 <NRf> Horizontal position co-ordinates
Return parameter	<NR3> Returns the cursor position.
Example	:CURSor:XY:RECTangular:X:POSition1 4.0E-3 Sets the X-coordinate cursor 1 position to 40mV/mV.

3-6-15. :CURSor:XY:RECTangular:X:DELta

→ Query

Description	Returns the delta value of cursor 1 and 2 on the X coordinate.
Syntax	:CURSor:XY:RECTangular:X:DELta {?}
Return Parameter	<NR3> Returns the delta value of cursor 1 and 2 as <NR3>.
Example	:CURSor:XY:RECTangular:X:DELta? 80.0E-3 Returns the horizontal delta as 80mV.

3-6-16. :CURSor:XY:RECTangular:Y:POSition<X>

Set →

→ Query

Description	Sets or queries the vertical position in XY mode for the Y rectangular coordinates for cursor 1 or 2.
Syntax	:CURSor:XY:RECTangular:Y:POSition<X> {NRf ?}
Parameter	<X> Cursor 1, 2 <NRf> Vertical position co-ordinates
Return parameter	<NR3> Returns the cursor position.
Example	:CURSor:XY:RECTangular:Y:POSition1 4.0E-3 Sets the Y-coordinate cursor 1 position to 40mV/mV.

3-6-17. :CURSor:XY:RECTangular:Y:DELta

→ Query

Description	Returns the delta value of cursor 1 and 2 on the Y coordinate.
Syntax	:CURSor:XY:RECTangular:Y:DELta {?}
Return Parameter	<NR3> Returns the delta value of cursor 1 and 2 as <NR3>.
Example	:CURSor:XY:RECTangular:Y:DELta? 80.0E-3 Returns the horizontal delta as 80mV.

3-6-18. :CURSor:XY:POLar:RADIUS:POSition<X>

→ Query

Description	Queries the polar radius position for the specified cursor in XY mode, where X can be either cursor 1 or 2.
Syntax	:CURSor:XY:POLar:RADIUS:POSition <X>{?}
Parameter	<X> 1, 2 (cursor 1, cursor 2)
Return Parameter	<NR3> Returns the polar radius position.
Example	:CURSor:XY:POLar:RADIUS:POSition? 80.0E-3 Returns the polar radius position as 80.0mV.

3-6-19. :CURSor:XY:POLar:RADIUS:DELta

→ Query

Description	Returns the radius delta value of cursor 1 and 2.
Syntax	:CURSor:XY:POLar:RADIUS:DELta {?}
Return Parameter	<NR3> Returns the radius delta.
Example	:CURSor:XY:POLar:RADIUS:DELta? 31.4E-3 Returns the radius delta as 31.4mV.

3-6-20. :CURSor:XY:POLar:THETA:POSition<X>

→ Query

Description	Queries the polar angle for the specified cursor in XY mode, where X can be either 1 or 2.
Syntax	:CURSor:XY:POLar:THETA:POSition<X> {?}
Parameter	<X> 1, 2 (Cursor 1, Cursor 2)
Return parameter	<NR3> Returns the polar angle.
Example	:CURSor:XY:POLar:RADIUS:POSition? 8.91E+1 Returns the polar angle for cursor1 as 89.1°.

3-6-21. :CURSor:XY:POLar:THETA:DELta

→ Query

Description	Queries the polar angle delta between cursor1 and cursor2.
Syntax	:CURSor:XY:POLar:THETA:DELta {?}
Return parameter	<NR3> Returns the theta delta between cursor1 and cursor2.
Example	:CURSor:XY:POLar:THETA:DELta? 9.10E+0 Returns the delta as 9.1°.

3-6-22. :CURSor:XY:PRODUct:POSItion<X>

→ Query

Description	Queries the product in XY mode for the specified cursor, where x can be either 1 or 2.
Syntax	:CURSor:XY:PRODUct:POSItion<X> {?}
Parameter	<X> 1, 2 (Cursor 1, Cursor 2)
Return parameter	<NR3> Returns the product value of the Cursor1 or Cursor2.
Example	:CURSor:XY:PRODUct:POSItion1? 9.44E-5 Returns the product of cursor1 as 94.4uVV.

3-6-23. :CURSor:XY:PRODUct:DELta

→ Query

Description	Queries the product delta in XY mode.
Syntax	:CURSor:XY:PRODUct:DELta {?}
Return parameter	<NR3> Returns the product delta.
Example	:CURSor:XY:PRODUct:DELta? 1.22E-5 Returns the product delta as 12.2uVV.

3-6-24. :CURSor:XY:RATIo:POSItion<X>

→ Query

Description	Queries the ratio in XY mode for the specified cursor, where x can be either cursor 1 or 2.
Syntax	:CURSor:XY:RATIo:POSItion<X> {?}
Parameter	<X> 1, 2 (Cursor 1, Cursor 2)
Return parameter	<NR3> Returns the ratio.
Example	:CURSor:XY:RATIo:POSItion? 6.717E+1 Returns the ratio value as 6.717V/V.

3-6-25. :CURSor:XY:RATio:DELta

→ Query

Description	Queries the ratio delta in XY mode.
Syntax	:CURSor:XY:RATio:DELta {?}
Return parameter	<NR3> Returns the ratio delta.
Example	:CURSor:XY:RATio:DELta? 5.39E+1 Returns the ratio delta as 53.9V/V.

3-7. Display Commands

3-7-1. :DISPlay:INTensity:WAVEform.....	42
3-7-2. :DISPlay:INTensity:GRATICule.....	42
3-7-3. :DISPlay:INTensity:BACKLight.....	43
3-7-4. :DISPlay:INTensity:BACKLight:AUTODim:ENable.....	43
3-7-5. :DISPlay:INTENSITY:BACKLight:AUTODim:TIME.....	43
3-7-6. :DISPlay:PERsistence.....	44
3-7-7. :DISPlay:GRATICule.....	44
3-7-8. :DISPlay:WAVEform.....	44
3-7-9. :DISPlay:OUTPut.....	45

3-7-1. :DISPlay:INTensity:WAVEform

Set →

→ Query

Description	Sets or queries the waveform intensity level.
Syntax	:DISPlay:INTensity:WAVEform {<NRf> ?}
Parameter	<NRf> 0.0E+0 to 1.0E+2 (0% to 100%)
Return Parameter	<NR3> Returns the display intensity.
Example	:DISPlay:INTensity:WAVEform 5.0E+1 Sets the waveform intensity to 50%.

3-7-2. :DISPlay:INTensity:GRATICule

Set →

→ Query

Description	Sets or queries the graticule intensity level.
Syntax	:DISPlay:INTensity:GRATICule {<NRf> ?}
Parameter	<NRf> 1.0E+0 to 1.0E+2 (10% to 100%)
Return Parameter	<NR3> Returns the graticule intensity.
Example	:DISPlay:INTensity:GRATICule 5.0E+1 Sets the graticule intensity to 50%.

3-7-3. :DISPlay:INTensity:BACKLight

Set →

→ Query

Description	Sets or queries the intensity of the backlight display.
Syntax	:DISPlay:INTensity:BACKLight {<NRf> ?}
Parameter	<NRf> 1.0E+0 to 1.0E+2 (10% to 100%)
Return Parameter	<NR3> Returns the backlight intensity.
Example	:DISPlay:INTensity:BACKLight 5.0E+1 Sets the backlight intensity to 50%.

3-7-4. :DISPlay:INTensity:BACKLight:AUTODim:ENable

Set →

→ Query

Description	Sets or queries the display auto-dim function.
Syntax	:DISPlay:INTensity:BACKLight:AUTODim :ENable {OFF ON ?}
Parameter/ Return parameter	OFF Turn auto-dim on. ON Turn auto-dim off.
Example	:DISPlay:INTensity:BACKLight:AUTODim:ENable ON Turns the auto-dim function on.

3-7-5. :DISPlay:INTENSITY:BACKLight:AUTODim:TIME

Set →

→ Query

Description	Sets or queries the display auto-dim time.
Syntax	:DISPlay:INTensity:BACKLight:AUTODim :TIME {<NR1> ?}
Parameter/ Return parameter	<NR1> 1 ~ 180 minutes. Time in minutes.
Example	:DISPlay:INTensity:BACKLight:AUTODim:TIME 10 Sets the auto-dim time to 10 minutes.



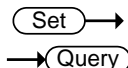

3-7-6. :DISPlay:PERsistence

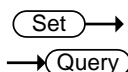

Description	Sets or queries the waveform persistence level.	
Syntax	:DISPlay:PERsistence { INFIinite OFF <NRf> ? }	
Parameter	<NRf>	16E-3, 30E-3, 60E-3, 120E-3, 240E-3, 500E-3, 750E-3, 1, 1.5, 2, ..., 9.5, 10 (16mS to 10S)
	INFIinite	Infinite persistence
	OFF	No persistence
Return Parameter	<NR3>	Returns the persistence time.
	INFIinite	Infinite persistence
	OFF	No persistence
Example	:DISPlay:PERsistence 2.0E+0 Sets the persistence to 2 seconds.	

3-7-7. :DISPlay:GRATicule



Description	Sets or queries graticule display type.	
Syntax	:DISPlay:GRATicule {FULL GRID CROSSs FRAMe ? }	
Parameter	FULL	
	FRAMe	
	CROSSs	
	GRID	
Return parameter	Returns the graticule type.	
Example	:DISPlay:GRATicule FULL Sets the graticule to  .	

3-7-8. :DISPlay:WAVEform

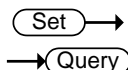

Description	Sets or queries whether the waveforms are drawn as vectors or dots.	
Syntax	:DISPlay:WAVEform {VECTor DOT ? }	
Parameter	VECTor	Vectors
	DOT	Dots
Return parameter	Returns VECTOR or DOT.	
Example	:DISPlay:WAVEform VECTor Sets the waveform to vectors.	

3-7-9. :DISPlay:OUTPut

→ Query

Description	Returns the screen image as a 16 bit RGB run length encoded image.
Syntax	:DISPlay:OUTPut ?
Return parameter	Returns: header + data + LF
Example	For example assuming the image data size is 31649 bytes then the following would be returned: #531649<[count] [color] [count] [color]..... ><LF> Where #531649 is the header, each [count] and [color] data are 2 bytes and <LF> is a line feed character.
Note:	On Windows 10, data loss may occur due to insufficient CPU power. Adjust the transfer timing with the ":USBDelay" command and use as fast a PC as possible.

3-8. Hardcopy Commands

3-8-1. :HARDcopy:START.....	45
3-8-2. :HARDcopy:MODE.....	46
3-8-3. :HARDcopy:PRINTINKSaver	46
3-8-4. :HARDcopy:SAVEINKSaver.....	46
3-8-5. :HARDcopy:SAVEFORMat	47
3-8-6. :HARDcopy:ASSIGN.....	47

3-8-1. :HARDcopy:START

Set →

Description	Executing the HARDcopy:START command is the equivalent of pressing the Hardcopy key on the front panel.
Syntax	:HARDcopy:START
Related Commands	:HARDcopy:MODE :HARDcopy:PRINTINKSaver :HARDcopy:SAVEINKSaver :HARDcopy:SAVEFORMat :HARDcopy:ASSIGN

3-8-2. :HARDcopy:MODE

Set →

→ Query

Description	Sets or queries whether hardcopy is set to print or save.
Syntax	:HARDcopy:MODE { PRINT SAVE ? }
Related Commands	:HARDcopy:START
Parameter	PRINT Print mode SAVE Save mode
Return parameter	Returns the mode.(PRINT/SAVE)
Example	:HARDcopy:MODE PRINT Sets hardcopy to print.

3-8-3. :HARDcopy:PRINTINKSaver

Set →

→ Query

Description	Sets Inksaver On or Off for printing.
Syntax	:HARDcopy:PRINTINKSaver { OFF ON ? }
Related Commands	:HARDcopy:START :HARDcopy:MODE
Parameter	ON Inksaver ON OFF Inksaver OFF
Return parameter	Returns the print Ink Saver mode.(ON/OFF)
Example	:HARDcopy:PRINTINKSaver ON Sets Ink Saver to ON for printing.

3-8-4. :HARDcopy:SAVEINKSaver

Set →

→ Query

Description	Sets Inksaver On or Off for saving screen images.
Syntax	:HARDcopy:SAVEINKSaver { OFF ON ? }
Related Commands	:HARDcopy:START :HARDcopy:MODE
Parameter	ON Inksaver ON OFF Inksaver OFF
Return parameter	Returns the screen image Ink Saver mode (ON/OFF).
Example	:HARDcopy:SAVEINKSaver ON Sets Inksaver to ON for saving screen images.

3-8-5. :HARDcopy:SAVEFORMat

Set →

→ Query

Description	Sets or queries the image save file type.
Syntax	:HARDcopy:SAVEFORMat { PNG BMP ? }
Related Commands	:HARDcopy:START :HARDcopy:MODE
Parameter	PNG PNG file format BMP BMP file format
Return parameter	Returns the image file format (PNG/BMP).
Example	:HARDcopy:SAVEFORMat PNG Sets the file format to PNG.

3-8-6. :HARDcopy:ASSIGN

Set →

→ Query

Description	Sets or queries what file type the hardcopy key has been assigned to save.
Syntax	:HARDcopy:ASSIGN {IMAGE WAVEform SETUp ALL ?}
Related Commands	:HARDcopy:START :HARDcopy:MODE
Parameter	IMAGE Save image files. WAVEform Save waveforms. SETUp Save the panel setup. ALL Save All (image, waveform,setup)
Return parameter	Returns the file type. (IMAGE/WAVEFORM/SETUP/ALL)
Example	:HARDcopy:ASSIGN IMAGE. Set the hardcopy key to save image files.

3-9. Measure Commands

3-9-1. :MEASure:GATing	49
3-9-2. :MEASure:SOURce.....	49
3-9-3. :MEASure:METHOD.....	49
3-9-4. :MEASUrement:REFLevel:PERCent:HIGH	50
3-9-5. :MEASUrement:REFLevel:PERCent:LOW	50
3-9-6. :MEASUrement:REFLevel:PERCent:MID.....	50
3-9-7. :MEASUrement:REFLevel:PERCent:MID2.....	50
3-9-8. :MEASure:FALL	51
3-9-9. :MEASure:FOVShoot	51
3-9-10. :MEASure:FPReshoot.....	51
3-9-11. :MEASure:FREQuency	52
3-9-12. :MEASure:NWIDth	52
3-9-13. :MEASure:PDUTy	53
3-9-14. :MEASure:PERiod.....	53
3-9-15. :MEASure:PWIDth	54
3-9-16. :MEASure:RISe.....	54
3-9-17. :MEASure:ROVShoot.....	55
3-9-18. :MEASure:RPReshoot	55
3-9-19. :MEASure:PPULSE	56
3-9-20. :MEASure:NPULSE	56
3-9-21. :MEASure:PEDGE	57
3-9-22. :MEASure:NEDGE	57
3-9-23. :MEASure:AMPlitude	58
3-9-24. :MEASure:MEAN	58
3-9-25. :MEASure:CMEan.....	59
3-9-26. :MEASure:HIGh.....	59
3-9-27. :MEASure:LOW	60
3-9-28. :MEASure:MAX.....	60
3-9-29. :MEASure:MIN	61
3-9-30. :MEASure:PK2PK.....	61
3-9-31. :MEASure:RMS.....	62
3-9-32. :MEASure:CRMS	62
3-9-33. :MEASure:AREa	63
3-9-34. :MEASure:CARea	63
3-9-35. :MEASure:FRRDelay	64
3-9-36. :MEASure:FRFDelay.....	64
3-9-37. :MEASure:FFRDelay.....	65
3-9-38. :MEASure:FFFDelay.....	65
3-9-39. :MEASure:LRRDelay	66
3-9-40. :MEASure:LRFDelay.....	66
3-9-41. :MEASure:LFRDelay.....	67
3-9-42. :MEASure:LFFDelay	67
3-9-43. :MEASure:PHAse	68

3-9-1. :MEASure:GATing

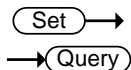

Description	Sets or queries the measurement gating.	
Syntax	:MEASure:GATing { OFF SCREEn CURSor ? }	
Parameter	OFF	Full record
	SCREEn	Gating set to screen width
	CURSor	Gating between cursors
Return parameter	Returns the gating. (OFF, SCREEN, CURSOR)	
Example	:MEASure:GATing OFF Turns gating off (full record).	

3-9-2. :MEASure:SOURce

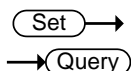

Description	Sets or queries the measurement source for source1 or source2.	
Syntax	:MEASure:SOURce<X> { CH1 CH2 CH3 CH4 MATH ? }	
Parameter	<X>	Source1 or source2
	CH1~CH4	Channel 1 to 4
	MATH	Math
Return parameter	Returns the source (CH1, CH2, CH3, CH4, MATH)	
Example	:MEASure:SOURce1 CH1 Sets source1 to channel 1.	

3-9-3. :MEASure:METHod

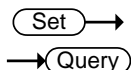

Description	Sets or queries the method used to determine the High-Low measurement values.	
Syntax	:MEASure:METHod { AUTo HIStogram MINMax ? }	
Parameter	AUTo	Set to auto.
	HIStogram	Set to the Histogram method.
	MINMax	Set to the Min-Max method.
Return parameter	Returns the measurement method (AUTO, HISTOGRAM, MINMAX)	
Example	:MEASure:METHod: AUTo Set the measurement method to auto.	

3-9-4. :MEASUrement:REFLevel:PERCent:HIGH

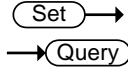

Description	Sets or queries the high reference level as a percentage.
Syntax	:MEASUrement:REFLevel:PERCent:HIGH {<NRf> ?}
Parameter	<NRf> 0 - 100%
Return parameter	Returns the high reference level
Example	:MEASUrement:REFLevel:PERCent:HIGH 50.1 Set the high reference level to 50.1%.

3-9-5. :MEASUrement:REFLevel:PERCent:LOW

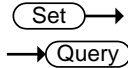

Description	Sets or queries the low reference level as a percentage.
Syntax	:MEASUrement:REFLevel:PERCent:LOW {<NRf> ?}
Parameter	<NRf> 0 - 100%
Return parameter	Returns the low reference level.
Example	:MEASUrement:REFLevel:PERCent:LOW 40.1 Set the low reference level to 40.1%.

3-9-6. :MEASUrement:REFLevel:PERCent:MID

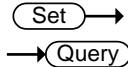

Description	Sets or queries the first mid reference level as a percentage.
Syntax	:MEASUrement:REFLevel:PERCent:MID {<NRf> ?}
Parameter	<NRf> 0 - 100%
Return parameter	Returns the mid reference level.
Example	:MEASUrement:REFLevel:PERCent:MID 50 Set the mid reference level to 50%.

3-9-7. :MEASUrement:REFLevel:PERCent:MID2

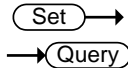

Description	Sets or queries the second mid reference level as a percentage.
Syntax	:MEASUrement:REFLevel:PERCent:MID2 {<NRf> ?}
Parameter	<NRf> 0 - 100%
Return parameter	Returns the mid reference level of the second source.
Example	:MEASUrement:REFLevel:PERCent:MID2 50 Set the mid reference level to 50%.

3-9-8. :MEASure:FALL

→ Query

Description	Returns the fall time measurement result.
Syntax	:MEASure:FALL{?}
Related Commands	:MEASure:SOURce<X>
Return parameter	<NR3> Indicates the source channel is not Chan Off activated.
Note	Before using this command, select the measurement channel. See the example below.
Example	:MEASure:SOURce1 CH1 :MEASure:FALL? Selects Channel 1 as the source, and then measures the fall time.

3-9-9. :MEASure:FOVShoot

→ Query

Description	Returns the fall overshoot amplitude.
Syntax	:MEASure:FOVShoot{?}
Related Commands	:MEASure:SOURce<X>
Return parameter	<NR3> Returns the fall overshoot as a percentage Chan Off Indicates the source channel is not activated.
Note	Before using this command, select the measurement channel. See the example below.
Example	:MEASure:SOURce1 CH1 :MEASure:FOVShoot? 1.27E+0 Selects Channel 1, and then measures the fall overshoot.

3-9-10. :MEASure:FPReshoot

→ Query

Description	Returns fall preshoot amplitude.
Syntax	:MEASure:FPReshoot{?}
Related Commands	:MEASure:SOURce<X>
Returns	Returns the fall preshoot as <NR3>.
Return parameter	<NR3> Returns the fall preshoot as a percentage. Chan Off Indicates the source channel is not activated.
Note	Before using this command, select the measurement channel. See the example below.
Example	:MEASure:SOURce1 CH1 :MEASure:FPReshoot? Selects Channel 1, and then measures the fall preshoot.

3-9-11. :MEASure:FREQuency

→ Query

Description	Returns the frequency value.
Syntax	:MEASure:FREQuency{?}
Related Commands	:MEASure:SOURce<X>
Return parameter	<NR3> Returns the frequency in Hz. Chan Off Indicates the source channel is not activated.
Note	Before using this command, select the measurement channel. See the example below.
Example	:MEASure:SOURce1 CH1 :MEASure:FREQuency? 1.0E+3 Selects Channel 1, and then measures the frequency.

3-9-12. :MEASure:NWIDth

→ Query

Description	Returns the first negative pulse width timing.
Syntax	:MEASure:NWIDth{?}
Related Commands	:MEASure:SOURce<X>
Return parameter	<NR3> Returns the negative pulse width in seconds. Chan Off Indicates the source channel is not activated.
Note	Before using this command, select the measurement channel. See the example below.
Example	:MEASure:SOURce1 CH1 :MEASure:NWIDth? 4.995E-04 Selects Channel 1, and then measures the negative pulse width.

3-9-13. :MEASure:PDUTy

→ Query

Description	Returns the positive duty cycle ratio as percentage.
Syntax	:MEASure:PDUTy{?}
Related commands	:MEASure:SOURce<X>
Return parameter	<NR3> Returns the positive duty ratio. Chan Off Indicates the source channel is not activated.
Note	Before using this command, select the measurement channel. See the example below.
Example	:MEASure:SOURce1 CH1 :MEASure:PDUTy? 5.000E+01 Selects Channel 1, and then measures the positive duty cycle.

3-9-14. :MEASure:PERiod

→ Query

Description	Returns the period.
Syntax	:MEASure:PERiod{?}
Related Commands	:MEASure:SOURce<X>
Return parameter	<NR3> Returns the period. Chan Off Indicates the source channel is not activated.
Note	Before using this command, select the measurement channel. See the example below.
Example	:MEASure:SOURce1 CH1 :MEASure:PERiod? 1.0E-3 Selects Channel 1, and then measures the period.

3-9-15. :MEASure:PWIDth

→ Query

Description	Returns the first positive pulse width.
Syntax	:MEASure:PWIDth{?}
Related Commands	:MEASure:SOURce<X>
Return parameter	<NR3> Returns the positive pulse width. Chan Off Indicates the source channel is not activated.
Note	Before using this command, select the measurement channel. See the example below.
Example	:MEASure:SOURce1 CH1 :MEASure:PWIDth? 5.0E-6 Selects Channel 1, and then measures the positive pulse width.

3-9-16. :MEASure:RISe

→ Query

Description	Returns the first pulse rise time.
Syntax	:MEASure:RISe{?}
Related Commands	:MEASure:SOURce<X>
Return parameter	<NR3> Returns the rise time. Chan Off Indicates the source channel is not activated.
Note	Before using this command, select the measurement channel. See the example below.
Example	:MEASure:SOURce1 CH1 :MEASure:RISe? 8.5E-6 Selects Channel 1, and then measures the rise time.

3-9-17. :MEASure:ROVShoot

→ Query

Description	Returns the rising overshoot over the entire waveform in percentage.
Syntax	:MEASure:ROVShoot{?}
Related Commands	:MEASure:SOURce<X>
Return parameter	<NR3> Returns the overshoot. Chan Off Indicates the source channel is not activated.
Note	Before using this command, select the measurement channel. See the example below.
Example	:MEASure:SOURce1 CH1 :MEASure:ROVShoot? 5.00E+00 Selects Channel 1, and then measures the rise overshoot.

3-9-18. :MEASure:RPReshoot

→ Query

Description	Returns rising preshoot over the entire waveform in percentage.
Syntax	:MEASure:RPReshoot{?}
Related Commands	:MEASure:SOURce<X>
Return parameter	<NR3> Returns the rising preshoot. Chan Off Indicates the source channel is not activated.
Note	Before using this command, select the measurement channel. See the example below.
Example	:MEASure:SOURce1 CH1 :MEASure:RPReshoot? 2.13E-2 Selects Channel 1, and then measures the rise preshoot.

3-9-19. :MEASure:PPULSE

→ Query

Description	Returns the number of positive pulses.
Syntax	:MEASure:PPULSE{?}
Related Commands	:MEASure:SOURce<X>
Return parameter	<NR3> Returns the number of positive pulses. Chan Off Indicates the source channel is not activated.
Note	Before using this command, select the measurement channel. See the example below.
Example	:MEASure:SOURce1 CH1 :MEASure:PPULSE? 6.000E+00 Selects Channel 1, and then measures the number of positive pulses.

3-9-20. :MEASure:NPULSE

→ Query

Description	Returns the number of negative pulses.
Syntax	:MEASure:NPULSE{?}
Related Commands	:MEASure:SOURce<X>
Return parameter	<NR3> Returns the number of negative pulses. Chan Off Indicates the source channel is not activated.
Note	Before using this command, select the measurement channel. See the example below.
Example	:MEASure:SOURce1 CH1 :MEASure:NPULSE? 4.000E+00 Selects Channel 1, and then measures the number of negative pulses.

3-9-21. :MEASure:PEDGE

→ Query

Description	Returns the number of positive edges.
Syntax	:MEASure:PEDGE{?}
Related Commands	:MEASure:SOURce<X>
Return parameter	<NR3> Returns the number of positive edges. Chan Off Indicates the source channel is not activated.
Note	Before using this command, select the measurement channel. See the example below.
Example	:MEASure:SOURce1 CH1 :MEASure:PEDGE? 1.100E+01 Selects Channel 1, and then measures the number of positive edges.

3-9-22. :MEASure:NEDGE

→ Query

Description	Returns the number of negative edges.
Syntax	:MEASure:NEDGE{?}
Related Commands	:MEASure:SOURce<X>
Return parameter	<NR3> Returns the number of negative edges. Chan Off Indicates the source channel is not activated.
Note	Before using this command, select the measurement channel. See the example below.
Example	:MEASure:SOURce1 CH1 :MEASure:NEDGE? 1.100E+01 Selects Channel 1, and then measures the number of negative edges.

3-9-23. :MEASure:AMPlitude

→ Query

Description	Returns the amplitude difference between the Vhigh-Vlow.
Syntax	:MEASure:AMPlitude{?}
Related Commands	:MEASure:SOURce<X>
Return parameter	<NR3> Returns the amplitude. Chan Off Indicates the source channel is not activated.
Note	Before using this command, select the measurement channel. See the example below.
Example	:MEASure:SOURce1 CH1 :MEASure:AMPlitude? 3.76E-3 Selects Channel 1, and then measures the amplitude.

3-9-24. :MEASure:MEAN

→ Query

Description	Returns the mean voltage/current of one or more full periods.
Syntax	:MEASure:MEAN{?}
Related Commands	:MEASure:SOURce<X>
Return parameter	<NR3> Returns the mean. Chan Off Indicates the source channel is not activated.
Note	Before using this command, select the measurement channel. See the example below.
Example	:MEASure:SOURce1 CH1 :MEASure:MEAN? 1.82E-3 Selects Channel 1, and then measures the mean value.

3-9-25. :MEASure:CMEan

→ Query

Description	Returns the mean voltage/current of one full period.
Syntax	:MEASure:CMEan{?}
Related Commands	:MEASure:SOURce<X>
Return parameter	<NR3> Returns the cyclic mean. Chan Off Indicates the source channel is not activated.
Note	Before using this command, select the measurement channel. See the example below.
Example	:MEASure:SOURce1 CH1 :MEASure:CMEan? 9.480E-01 Selects Channel 1, and then measures the mean value of the first period.

3-9-26. :MEASure:HIGh

→ Query

Description	Returns the high voltage/current.
Syntax	:MEASure:HIGh{?}
Related Commands	:MEASure:SOURce<X>
Return parameter	<NR3> Returns the high value. Chan Off Indicates the source channel is not activated.
Note	Before using this command, select the measurement channel. See the example below.
Example	:MEASure:SOURce1 CH1 :MEASure:HIGh? 3.68E-3 Selects Channel 1, and then measures the high voltage/current.

3-9-27. :MEASure:LOW

→ Query

Description	Returns the low voltage/current.				
Syntax	:MEASure:LOW{?}				
Related Commands	:MEASure:SOURce<X>				
Return parameter	<table border="0"> <tr> <td><NR3></td> <td>Returns the global low value.</td> </tr> <tr> <td>Chan Off</td> <td>Indicates the source channel is not activated.</td> </tr> </table>	<NR3>	Returns the global low value.	Chan Off	Indicates the source channel is not activated.
<NR3>	Returns the global low value.				
Chan Off	Indicates the source channel is not activated.				
Note	Before using this command, select the measurement channel. See the example below.				
Example	<pre>:MEASure:SOURce1 CH1 :MEASure:LOW? 1.00E-0</pre> <p>Selects Channel 1, and then measures the low current/voltage.</p>				

3-9-28. :MEASure:MAX

→ Query

Description	Returns the maximum amplitude.				
Syntax	:MEASure:MAX{?}				
Related Commands	:MEASure:SOURce<X>				
Return parameter	<table border="0"> <tr> <td><NR3></td> <td>Returns the maximum amplitude.</td> </tr> <tr> <td>Chan Off</td> <td>Indicates the source channel is not activated.</td> </tr> </table>	<NR3>	Returns the maximum amplitude.	Chan Off	Indicates the source channel is not activated.
<NR3>	Returns the maximum amplitude.				
Chan Off	Indicates the source channel is not activated.				
Note	Before using this command, select the measurement channel. See the example below.				
Example	<pre>:MEASure:SOURce1 CH1 :MEASure:MAX? 1.90E-3</pre> <p>Selects Channel 1, and then measures the maximum amplitude.</p>				

3-9-29. :MEASure:MIN

→ Query

Description	Returns the minimum amplitude.
Syntax	:MEASure:MIN{?}
Related Commands	:MEASure:SOURce<X>
Return parameter	<NR3> Returns the minimum amplitude. Chan Off Indicates the source channel is not activated.
Note	Before using this command, select the measurement channel. See the example below.
Example	:MEASure:SOURce1 CH1 :MEASure:MIN? -8.00E-3 Selects Channel 1, and then measures the minimum amplitude.

3-9-30. :MEASure:PK2PK

→ Query

Description	Returns the peak-to-peak amplitude (difference between maximum and minimum amplitude).
Syntax	:MEASure:PK2Pk{?}
Related Commands	:MEASure:SOURce<X>
Return parameter	<NR3> Returns the voltage or current peak to peak measurement. Chan Off Indicates the source channel is not activated.
Note	Before using this command, select the measurement channel. See the example below.
Example	:MEASure:SOURce1 CH1 :MEASure:PK2Pk? 2.04E-1 Selects Channel 1, and then measures the peak-to-peak amplitude.

3-9-31. :MEASure:RMS

→ Query

Description	Returns the root-mean-square voltage/current of one or more full periods.
Syntax	:MEASure:RMS{?}
Related Commands	:MEASure:SOURce<X>
Return parameter	<NR3> Returns the RMS value. Chan Off Indicates the source channel is not activated.
Note	Before using this command, select the measurement channel. See the example below.
Example	:MEASure:SOURce1 CH1 :MEASure:RMS? 1.31E-3 Selects Channel 1, and then measures the RMS voltage/current.

3-9-32. :MEASure:CRMS

→ Query

Description	Returns the root-mean-square voltage/current of one full periods.
Syntax	:MEASure:CRMS{?}
Related Commands	:MEASure:SOURce<X>
Return parameter	<NR3> Returns the CRMS value. Chan Off Indicates the source channel is not activated.
Note	Before using this command, select the measurement channel. See the example below.
Example	:MEASure:SOURce1 CH1 :MEASure:CRMS? 1.31E-3 Selects Channel 1, and then measures the CRMS voltage/current.

3-9-33. :MEASure:AREa

→ Query

Description	Returns the voltage/current area over one or more full periods.
Syntax	:MEASure:AREa{?}
Related Commands	:MEASure:SOURce<X>
Return parameter	<NR3> Returns the area value. Chan Off Indicates the source channel is not activated.
Note	Before using this command, select the measurement channel. See the example below.
Example	:MEASure:SOURce1 CH1 :MEASure:AREa? 1.958E-03 Selects Channel 1, and then measures the area.

3-9-34. :MEASure:CARea

→ Query

Description	Returns the voltage/current area over one full period.
Syntax	:MEASure:CARea{?}
Related Commands	:MEASure:SOURce<X>
Return parameter	<NR3> Returns the area value. Chan Off Indicates the source channel is not activated.
Note	Before using this command, select the measurement channel. See the example below.
Example	:MEASure:SOURce1 CH1 :MEASure:CARea? 1.958E-03 Selects Channel 1, and then measures the area.

3-9-35. :MEASure:FRRDelay

→ Query

Description	Returns the delay between the first rising edge of source1 and the first rising edge of source2.
Syntax	:MEASure:FRRDelay{?}
Related Commands	:MEASure:SOURce<X>
Return parameter	<NR3> Returns the delay. Chan Off Indicates the source channel is not activated.
Note	Select the two source channels before entering this command.
Example	:MEASure:SOURce1 CH1 :MEASure:SOURce2 CH2 :MEASure:FRRDelay? -4.68E-6 Select channel 1 and 2 as source1/2, and then measure FRR.

3-9-36. :MEASure:FRFDelay

→ Query

Description	Returns the delay between the first rising edge of source1 and the first falling edge of source2.
Syntax	:MEASure:FRFDelay{?}
Related Commands	:MEASure:SOURce<X>
Return parameter	<NR3> Returns the delay. Chan Off Indicates the source channel is not activated.
Note	Select the two source channels before entering this command.
Example	:MEASure:SOURce1 CH1 :MEASure:SOURce2 CH2 :MEASure:FRFDelay? 3.43E-6 Select channel 1 and 2 as source1/2, and then measure FRF.

3-9-37. :MEASure:FFRDelay

→ Query

Description	Returns the delay between the first falling edge of source1 and the first rising edge of source2.
Syntax	:MEASure:FRRDelay {?}
Related Commands	:MEASure:SOURce<X>
Return parameter	<NR3> Returns the delay. Chan Off Indicates the source channel is not activated.
Note	Select the two source channels before entering this command.
Example	:MEASure:SOURce1 CH1 :MEASure:SOURce2 CH2 :MEASure:FRRDelay? -8.56E-6 Select channel 1 and 2 as delay source1/2, and then measure FFR.

3-9-38. :MEASure:FFFDelay

→ Query

Description	Returns the delay between the first falling edge of source1 and the first falling edge of source2.
Syntax	:MEASure:FFFDelay{?}
Related Commands	:MEASure:SOURce<X>
Return parameter	<NR3> Returns the delay. Chan Off Indicates the source channel is not activated.
Note	Select the two source channels before entering this command.
Example	:MEASure:SOURce1 CH1 :MEASure:SOURce2 CH2 :MEASure:FFFDelay? -8.89E-6 Select channel 1 and 2 as delay source1/2, and then measure FFF.

3-9-39. :MEASure:LRRDelay

→ Query

Description	Returns the delay between the first rising edge of source1 and the last rising edge of source2.
Syntax	:MEASure:LRRDelay{?}
Related Commands	:MEASure:SOURce<X>
Return parameter	<NR3> Returns the delay. Chan Off Indicates the source channel is not activated.
Note	Select the two source channels before entering this command.
Example	:MEASure:SOURce1 CH1 :MEASure:SOURce2 CH2 : MEASure:LRRDelay? -8.89E-6 Select channel 1 and 2 as delay source1/2, and then measure LRR.

3-9-40. :MEASure:LRFDelay

→ Query

Description	Returns the delay between the first rising edge of source1 and the last rising edge of source2.
Syntax	:MEASure:LRFDelay{?}
Related Commands	:MEASure:SOURce<X>
Return parameter	<NR3> Returns the delay. Chan Off Indicates the source channel is not activated.
Note	Select the two source channels before entering this command.
Example	:MEASure:SOURce1 CH1 :MEASure:SOURce2 CH2 :MEASure:LRFDelay? -4.99E-6 Select channel 1 and 2 as delay source1/2, and then measure LRF.

3-9-41. :MEASure:LFRDelay

→ Query

Description	Returns the delay between the first falling edge of source1 and the last rising edge of source2.
Syntax	:MEASure:LFRDelay{?}
Related Commands	:MEASure:SOURce<X>
Return parameter	<NR3> Returns the delay. Chan Off Indicates the source channel is not activated.
Note	Select the two source channels before entering this command.
Example	:MEASure:SOURce1 CH1 :MEASure:SOURce2 CH2 :MEASure:LFRDelay? -9.99E-6 Select channel 1 and 2 as delay source1/2, and then measure LFR.

3-9-42. :MEASure:LFFDelay

→ Query

Description	Returns the delay between the first falling edge of source1 and the last falling edge of source2.
Syntax	:MEASure:LFFDelay{?}
Related Commands	:MEASure:SOURce<X>
Return parameter	<NR3> Returns the delay. Chan Off Indicates the source channel is not activated.
Note	Select the two source channels before entering this command.
Example	:MEASure:SOURce1 CH1 :MEASure:SOURce2 CH2 :MEASure:LFFDelay? -9.99E-6 Select channel 1 and 2 as delay source1/2, and then measure LFF.

3-9-43. :MEASure:PHase

→ Query

Description	Returns the phase between source 1 and source 2.
Syntax	:MEASure:PHase{?}
Related Commands	:MEASure:SOURce<X>
Return parameter	<NR3> Returns the phase difference. Chan Off Indicates the source channel is not activated.
Note	Select the two source channels before entering this command.
Example	:MEASure:SOURce1 CH1 :MEASure:SOURce2 CH2 :MEASure:PHase? 4.50E+01 Select channel 1 and 2 as phase source1/2, and then measure the phase in degrees.

3-10. Measurement Commands

3-10-1. :MEASUrement:MEAS<X>:SOURCE<X>	69
3-10-2. :MEASUrement:MEAS<X>:TYPe	70
3-10-3. :MEASUrement:MEAS<X>:STATE	70
3-10-4. :MEASUrement:MEAS<X>:VALue	71
3-10-5. :MEASUrement:MEAS<X>:MAXimum	71
3-10-6. :MEASUrement:MEAS<X>:MEAN.....	72
3-10-7. :MEASUrement:MEAS<X>:MINImum	72
3-10-8. :MEASUrement:MEAS<X>:STDdev	73
3-10-9. :MEASUrement:STATIstics:MODE.....	73
3-10-10. :MEASUrement:STATIstics:WEIghting.....	73
3-10-11. :MEASUrement:STATIstics	74

3-10-1. :MEASUrement:MEAS<X>:SOURCE<X>

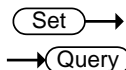

Description	Sets or queries the measurement source for a selected automatic measurement. This is a statistics related command.	
Syntax	:MEASUrement:MEAS<X>:SOURCE<X> {CH1 CH2 CH3 CH4 MATH ? }	
Related commands	:MEASUrement:MEAS<X>:TYPE	
Parameter	MEAS<X>	The automatic measurement number from 1 to 8.
	SOURCE<X>	SOURCE1: the source for all single channel measurements.
	SOURCE<X>	SOURCE2: the source for all delay or phase measurements.
	CH1 to CH4	Channel 1, 2, 3, 4
	MATH	Math source
Return parameter	CH1 to CH4	Channel 1, 2, 3, 4
	MATH	Math source
Example	:MEASUrement:MEAS1:SOURCE1 CH1 Returns the (first) source for measurement 1.	

3-10-2. :MEASUREMENT:MEAS<X>:TYPE

Set →

→ Query

Description	Sets or queries the measurement type for a selected automatic measurement. This is a statistics related command.
Syntax	:MEASUREMENT:MEAS<X>:TYPE {PK2pk MAXimum MINimum AMPLitude HIGH LOW MEAN CMEan RMS CRMs AREa CARea ROVShoot FOVShoot RPReshoot FPReshoot FREQuency PERiod RISE FALL PWIdth NWIdth PDUTY PPULSE NPULSE PEDGE NEDGE FRRDelay FRFDelay FFRDelay FFFDelay LRRDelay LRFDelay LFRDelay LFFDelay PHASE ? }
Related commands	:MEASUREMENT:MEAS<X>:SOURCE<X>
Parameter	MEAS<X> The automatic measurement number from 1 to 8.
Return parameter	Returns the measurement type
Example	:MEASUREMENT:MEAS1:TYPE RMS Sets measurement 1 to RMS measurement.

3-10-3. :MEASUREMENT:MEAS<X>:STATE

Set →

→ Query

Description	Sets or queries the state of a selected measurement. This is a statistics related command.
Syntax	:MEASUREMENT:MEAS<X>:STATE { ON OFF 1 0 ? }
Related commands	:MEASUREMENT:MEAS<X>:SOURCE<X> :MEASUREMENT:MEAS<X>:TYPE
Parameter	MEAS<X> The automatic measurement number from 1 to 8. ON/1 Turn the measurement on. OFF/0 Turn the measurement off.
Return parameter	0 Measurement is off. 1 Measurement is on.
Example	:MEASUREMENT:MEAS1:STATE 1 Turns measurement 1 on.

3-10-4. :MEASUrement:MEAS<X>:VALue

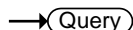

Description	Returns the measurement results for the selected measurement. This is a statistics related command.
Syntax	:MEASUrement:MEAS<X>:VALue?
Related Commands	:MEASUre:SOURce<X>
Return parameter	MEAS<X> The automatic measurement number from 1 to 8.
Note	The measurement source(s), measurement number, measurement type and measurement state must first be set before a measurement result can be returned.
Example	:MEASUrement:MEAS1:SOURce1 CH1 :MEASUrement:MEAS1:TYPe PK2PK :MEASUrement:MEAS1:STATE ON :MEASUrement:MEAS1:VALue? 5.000E+0 Selects channel 1 as the source for measurement 1, sets measurement 1 to peak to peak measurement and then turns on the measurement. The result returns the peak to peak measurement.

3-10-5. :MEASUrement:MEAS<X>:MAXimum

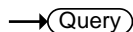

Description	Returns the maximum measurement results for the selected measurement from the last time the statistics were reset. This is a statistics related command.
Syntax	:MEASUrement:MEAS<X>:MAXimum?
Related Commands	:MEASUrement:STATIstics:MODE
Parameter	MEAS<X> The automatic measurement number from 1 to 8.
Example	:MEASUrement:MEAS3:SOURce1 CH1 :MEASUrement:MEAS3:TYPe PK2PK :MEASUrement:MEAS3:STATE ON :MEASUrement:STATIstics:MODE ON :MEASUrement:MEAS3:MAXimum? 2.800E-02 Returns the maximum measurement result for measurement number 3.

3-10-6. :MEASUrement:MEAS<X>:MEAN

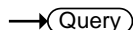

Description	Returns the mean measurement results for the selected measurement from the last time the statistics were reset. This is a statistics related command.
Syntax	:MEASUrement:MEAS<X>:MEAN?
Related Commands	:MEASUrement:STATIstics:MODE
Parameter	MEAS<X> The automatic measurement number from 1 to 8.
Example	:MEASUrement:MEAS3:SOUrce1 CH1 :MEASUrement:MEAS3:TYPe PK2PK :MEASUrement:MEAS3:STATE ON :MEASUrement:STATIstics:MODE ON :MEASUrement:MEAS3:MEAN? 2.090E-02 Returns the mean measurement result for measurement number 3.

3-10-7. :MEASUrement:MEAS<X>:MINImum

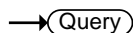

Description	Returns the minimum measurement results for the selected measurement from the last time the statistics were reset. This is a statistics related command.
Syntax	:MEASUrement:MEAS<X>:MINImum?
Related Commands	:MEASUrement:STATIstics:MODE
Parameter	MEAS<X> The automatic measurement number from 1 to 8.
Example	:MEASUrement:MEAS3:SOUrce1 CH1 :MEASUrement:MEAS3:TYPe PK2PK :MEASUrement:MEAS3:STATE ON :MEASUrement:STATIstics:MODE ON :MEASUrement:MEAS3:MINImum? 1.600E-02 Returns the minimum measurement result for measurement number 3.

3-10-8. :MEASUrement:MEAS<X>:STDdev

→ Query

Description	Returns the standard deviation for the selected measurement from the last time the statistics were reset. This is a statistics related command.
Syntax	:MEASUrement:MEAS<X>:STDdev?
Related Commands	:MEASUrement:STATIstics:MODE
Parameter	MEAS<X> The automatic measurement number from 1 to 8.
Example	:MEASUrement:MEAS3:SOUrce1 CH1 :MEASUrement:MEAS3:TYPe PK2PK :MEASUrement:MEAS3:STATE ON :MEASUrement:STATIstics:MODE ON :MEASUrement:MEAS3:STDdev? 1.530E-03 Returns the standard deviation for measurement number 3.

3-10-9. :MEASUrement:STATIstics:MODE

Set →

→ Query

Description	Puts the statics measurement results on the display or queries whether the statics are displayed.
Syntax	:MEASUrement:STATIstics:MODE {OFF ON ?}
Related commands	:MEASUrement:STATIstics
Parameter/ Return parameter	ON Display the statistics on the screen. OFF Remove the statistics from the screen
Example	:MEASUrement:STATIstics:MODE ON Displays statistics on the screen.

3-10-10. :MEASUrement:STATIstics:WEIghting

Set →

→ Query

Description	Sets and queries the number of samples used for the statistics calculations.
Syntax	:MEASUrement:STATIstics:WEIghting { <NR1> ? }
Parameter/ Return parameter	<NR1> Number of samples (2~1000)
Example	:MEASUrement:STATIstics:WEIghting 5 Sets the number of samples to 5.

3-10-11. :MEASUREMENT:STATISTICS

(Set) →

Description	Resets the statics calculations. This command will clear all the currently accumulated measurements.
Syntax	:MEASUREMENT:STATISTICS RESET

3-11. Reference Commands

3-11-1. :REF<X>:DISPLAY	74
3-11-2. :REF<X>:TIMEBASE:POSITION.....	74
3-11-3. :REF<X>:TIMEBASE:SCALE	75
3-11-4. :REF<X>:OFFSET.....	75
3-11-5. :REF<x>:SCALE	75

3-11-1. :REF<X>:DISPLAY

(Set) →

→ (Query)

Description	Sets or queries a reference waveform to be shown on the display. A reference waveform must first be saved before this command can be used.
Syntax	:REF<X>:DISPLAY { OFF ON ? }
Parameter	<X> Reference waveform 1, 2, 3, 4. OFF Turns the selected reference waveform off ON Turns the selected reference waveform on
Return parameter	Returns the status of the selected reference waveform. (OFF, ON)
Example	:REF1:DISPLAY ON Turns on reference1 (REF 1) on the display.

3-11-2. :REF<X>:TIMEBASE:POSITION

(Set) →

→ (Query)

Description	Sets or returns the selected reference waveform time base position.
Syntax	:REF<X>:TIMEBASE:POSITION { <NRf> ? }
Related commands	:REF<X>:DISPLAY
Parameter	<X> Reference waveform 1, 2, 3, 4. <NRf> Horizontal co-ordinates
Return parameter	<NR3> Returns the reference waveform position
Example	:REF1:TIMEBASE:POSITION -5.000E-5 Selects reference 1, and then sets the horizontal position to -50us.

3-11-3. :REF<X>:TIMEbase:SCALE

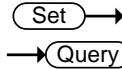

Description	Sets or returns the selected reference waveform time base scale.
Syntax	:REF<X>:TIMEbase:SCALE { <NRf> ?}
Related commands	:REF<X>:DISPlay
Parameter	<X> Reference waveform 1, 2, 3, 4. <NRf> Horizontal scale
Return parameter	<NR3> Returns the reference waveform scale.
Example	:REF1:TIMEbase:SCALE 5.00E-4 Selects reference 1, and then sets the horizontal scale to 500us/div.

3-11-4. :REF<X>:OFFSet

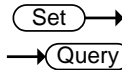

Description	Sets or returns the selected reference waveform vertical position (offset).
Syntax	:REF<X>:OFFSet { <NRf> ?}
Related commands	:REF<X>:DISPlay
Parameter	<X> Reference waveform 1, 2, 3, 4. <NRf> Vertical offset
Return parameter	<NR3> Returns the reference waveform vertical position.
Example	:REF1:OFFSet -5.000E-2 Selects reference 1, and then sets the vertical position to -50mV/mA.

3-11-5. :REF<x>:SCALE

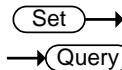

Description	Sets or returns the selected reference waveform vertical scale.
Syntax	:REF<x>:SCALE { <NRf> ?}
Related commands	:REF<X>:DISPlay
Parameter	<X> Reference waveform 1, 2, 3, 4. <NRf> Vertical scale
Return parameter	<NR3> Returns the reference waveform vertical scale.
Example	:REF1:SCALE 5.000E-2 Selects reference 1, and then sets the vertical scale to 50mV mA/div.

3-12. Run Command

3-12-1. :RUN	76
3-12-2. :STOP	76
3-12-3. :SINGle	76
3-12-4. :FORCe	76

3-12-1. :RUN

Set →

Description	The run command allows the oscilloscope to continuously make acquisitions (equivalent to pressing the Run key on the front panel).
Syntax	:RUN

3-12-2. :STOP

Set →

Description	The stop command stops the oscilloscope making further acquisitions (equivalent to pressing the Stop key on the front panel).
Syntax	:STOP

3-12-3. :SINGle

Set →

Description	The single command allows the oscilloscope to capture a single acquisition when trigger conditions have been fulfilled (equivalent to pressing the Single key on the front panel).
Syntax	:SINGle

3-12-4. :FORCe

Set →

Description	The Force command forces an acquisition (equivalent to pressing the Force-Trig key on the front panel).
Syntax	:FORCe

3-13. Timebase Commands

3-13-1. :TIMebase:EXPand	77
3-13-2. :TIMebase:POSition	77
3-13-3. :TIMebase:SCALE	77
3-13-4. :TIMebase:MODE	78
3-13-5. :TIMebase:WINDow:POSition	78
3-13-6. :TIMebase:WINDow:SCALE	78

3-13-1. :TIMebase:EXPand

Set →

→ Query

Description	Sets or queries the horizontal expansion mode.
Syntax	:TIMebase:EXPand {CENTER TRIGger ?}
Parameter/	CENTER Expand from the center of the display.
Return parameter	TRIGger Expand from the trigger point.
Example	:TIMebase:EXPand TRIGger Sets the expansion point to the trigger point.

3-13-2. :TIMebase:POSition

Set →

→ Query

Description	Sets or queries the horizontal position.
Syntax	:TIMebase:POSition {<NRf> ?}
Parameter	<NRf> Horizontal position
Return parameter	<NR3> Returns the horizontal position.
Example	:TIMebase:POSition 5.00E-4 Sets the horizontal position as 500us.

3-13-3. :TIMebase:SCALE

Set →

→ Query

Description	Sets or queries the horizontal scale.
Syntax	:TIMebase:SCALE {<NRf> ?}
Parameter	<NRf> Horizontal scale
Return parameter	<NR3> Returns the horizontal scale.
Example	:TIMebase:SCALE 5.00E-2 Sets the horizontal scale to 50ms/div.

3-13-4. :TIMebase:MODE

Set →

→ Query

Description	Sets or queries the time base mode. The time base mode determines the display view window on the scope.	
Syntax	:TIMebase:MODE {MAIN WINDow XY ?}	
Parameter	MAIN	Sets the time base mode to the main screen.
	WINDow	Sets the time base mode to the zoom window.
	XY	Sets the time base mode to the XY display.
Return parameter	Returns the time base mode (MAIN, WINDOW, XY)	
Example	:TIMebase:MODE MAIN Sets the time base mode to the main mode.	

3-13-5. :TIMebase:WINDow:POSition

Set →

→ Query

Description	Sets or queries the zoom horizontal position.	
Syntax	:TIMebase:WINDow:POSition {<NRf> ?}	
Related commands	:TIMebase:MODE	
Parameter	<NRf>	Horizontal position for zoom window
Return parameter	<NR3>	Returns the zoom horizontal position.
Example	:TIMebase:WINDow:POSition 2.0E-3 Sets the zoom horizontal position as 20ms.	

3-13-6. :TIMebase:WINDow:SCALE

Set →

→ Query

Description	Sets or queries the zoom horizontal scale.	
Note	If the oscilloscope is under "ZOOM" mode, the main timebase function will be disabled and cannot be modified.	
Syntax	:TIMebase:WINDow:SCALE {<NRf> ?}	
Related commands	:TIMebase:MODE	
Parameter	<NRf>	Zoom horizontal scale. The range will depend on the time base.
Return parameter	<NR3>	Returns the zoom horizontal scale.
Example	:TIMebase:WINDow:SCALE 2.0E-3 Sets the zoom horizontal scale to 2ms.	

3-14. Trigger Commands

3-14-1. :TRIGger:FREQuency.....	80
3-14-2. :TRIGger:TYPe.....	80
3-14-3. :TRIGger:SOURce.....	81
3-14-4. :TRIGger:COUPle.....	81
3-14-5. :TRIGger:NREJ.....	81
3-14-6. :TRIGger:MODE.....	82
3-14-7. :TRIGger:HOLDoff.....	82
3-14-8. :TRIGger:LEVel.....	82
3-14-9. :TRIGger:HLEVel.....	83
3-14-10. :TRIGger:LLEVel.....	83
3-14-11. :TRIGger:EDGE:SLOP.....	84
3-14-12. :TRIGger:DELaY:SLOP.....	84
3-14-13. :TRIGger:DELaY:TYPe.....	84
3-14-14. :TRIGger:DELaY:TIME.....	85
3-14-15. :TRIGger:DELaY:EVENT.....	85
3-14-16. :TRIGger:DELaY:LEVel.....	85
3-14-17. :TRIGger:PULSEWidth:POLarity.....	86
3-14-18. :TRIGger:RUNT:POLarity.....	86
3-14-19. :TRIGger:RUNT:WHEn.....	86
3-14-20. :TRIGger:RUNT:Time.....	87
3-14-21. :TRIGger:RISEFall:SLOP.....	87
3-14-22. :TRIGger:RISEFall:WHEn.....	87
3-14-23. :TRIGger:RISEFall:TIME.....	88
3-14-24. :TRIGger:VIDeo:TYPe.....	88
3-14-25. :TRIGger:VIDeo:FIELD.....	89
3-14-26. :TRIGger:VIDeo:LINE.....	89
3-14-27. :TRIGger:VIDeo:POLarity.....	89
3-14-28. :TRIGger:PULSE:WHEn.....	90
3-14-29. :TRIGger:PULSE:TIME.....	90
3-14-30. :TRIGger:TIMEOut:WHEn.....	90
3-14-31. :TRIGger:TIMEOut:TIMER.....	91
3-14-32. :TRIGger:ALTErnate.....	91
3-14-33. :TRIGger:STATE.....	91
3-14-34. :TRIGger:EXTErnal:PROBe:TYPe.....	92
3-14-35. :TRIGger:EXTErnal:PROBe:RATio.....	92
3-14-36. :TRIGger:BUS:TYPe.....	92
3-14-37. :TRIGger:BUS:THREshold:CH<x>.....	93
3-14-38. :TRIGger:BUS:B1:I2C:CONDition.....	93
3-14-39. :TRIGger:BUS:B1:I2C:ADDRes:MODE.....	94
3-14-40. :TRIGger:BUS:B1:I2C:ADDRes:TYPe.....	94
3-14-41. :TRIGger:BUS:B1:I2C:ADDRes:VALue.....	95
3-14-42. :TRIGger:BUS:B1:I2C:ADDRes:DIRection.....	95
3-14-43. :TRIGger:BUS:B1:I2C:DATA:SIZE.....	96
3-14-44. :TRIGger:BUS:B1:I2C:DATA:VALue.....	96
3-14-45. :TRIGger:BUS:B1:UART:CONDition.....	97
3-14-46. :TRIGger:BUS:B1:UART:RX:DATA:SIZE.....	97
3-14-47. :TRIGger:BUS:B1:UART:RX:DATA:VALue.....	98
3-14-48. :TRIGger:BUS:B1:UART:TX:DATA:SIZE.....	98
3-14-49. :TRIGger:BUS:B1:UART:TX:DATA:VALue.....	99
3-14-50. :TRIGger:BUS:B1:SPI:CONDition.....	99
3-14-51. :TRIGger:BUS:B1:SPI:DATA:SIZE.....	100

3-14-52. :TRIGger:BUS:B1:SPI:DATA:MISO:VALue.....	100
3-14-53. :TRIGger:BUS:B1:SPI:DATA:MOSI:VALue.....	101
3-14-54. :TRIGger:BUS:B1:CAN:CONDition	102
3-14-55. :TRIGger:BUS:B1:CAN:FRAMeType	102
3-14-56. :TRIGger:BUS:B1:CAN:IDentifier:MODE	103
3-14-57. :TRIGger:BUS:B1:CAN:IDentifier:VALue.....	103
3-14-58. :TRIGger:BUS:B1:CAN:IDentifier:DIRection.....	104
3-14-59. :TRIGger:BUS:B1:CAN:DATA:QUALifier	104
3-14-60. :TRIGger:BUS:B1:CAN:DATA:SIZE.....	105
3-14-61. :TRIGger:BUS:B1:CAN:DATA:VALue.....	105
3-14-62. :TRIGger:BUS:B1:LIN:CONDition	106
3-14-63. :TRIGger:BUS:B1:LIN:DATA:QUALifier.....	107
3-14-64. :TRIGger:BUS:B1:LIN:DATA:SIZE.....	108
3-14-65. :TRIGger:BUS:B1:LIN:DATA:VALue.....	108
3-14-66. :TRIGger:BUS:B1:LIN:ERRTYPE.....	109
3-14-67. :TRIGger:BUS:B1:LIN:IDentifier:VALue.....	109

3-14-1. :TRIGger:FREQuency

→ Query

Description	Queries the trigger frequency.
Syntax	:TRIGger:FREQuency{?}
Return parameter	<NR3> Returns the trigger frequency.
Example	:TRIGger:FREQuency? 1.032E+3 Returns the trigger frequency.

3-14-2. :TRIGger:TYPe

Set →

→ Query

Description	Sets or queries the trigger type.
Syntax	:TRIGger:TYPe {EDGE DELay PULSEWidth VIDEo RUnt RISEFall BUS TIMEOut ? }
Parameter	EDGE Edge trigger DELay Delay trigger PULSEWidth Pulse width trigger VIDeo Video trigger RUnt Runt trigger RISEFall Rise and fall trigger BUS Bus trigger TIMEOut Timeout trigger
Return parameter	Returns the trigger type.
Example	:TRIGger:TYPe EDGE Sets the trigger type to edge.

3-14-3. :TRIGger:SOURce

Set →

→ Query

Description	Sets or queries the trigger source.	
Syntax	:TRIGger:SOURce	
	{ CH1 CH2 CH3 CH4 EXT LINE ? }	
Parameter	CH1 to CH4	Channel 1 to channel 4
	EXT	External source
	LINE	AC Line
Return parameter	Returns the trigger source.	
Example	:TRIGger:SOURce CH1 Sets the trigger source to channel 1.	

3-14-4. :TRIGger:COUPle

Set →

→ Query

Description	Sets or queries the trigger coupling.	
Note	Applicable for edge and delay triggers only.	
Syntax	:TRIGger:COUPle {AC DC ?}	
Parameter	AC	AC Mode
	DC	DC Mode
	HF	High frequency rejection
	LF	Low frequency rejection
Return parameter	Returns the trigger coupling.	
Example	:TRIGger:COUPle AC Sets the trigger coupling to AC.	

3-14-5. :TRIGger:NREJ

Set →

→ Query

Description	Sets or queries noise rejection status.	
Syntax	:TRIGger:NREJ {OFF ON ?}	
Parameter	OFF	Turns noise rejection off
	ON	Turns noise rejection on
Return parameter	Returns the noise rejection status (ON, OFF).	
Example	:TRIGger:NREJ ON Turns noise rejection on.	

3-14-6. :TRIGger:MODE

Set →

→ Query

Description	Sets or queries the trigger mode.	
Syntax	:TRIGger:MODE {AUTo NORMal ?}	
Parameter	AUTo	Auto trigger (Untriggered roll)
	NORMal	Normal trigger
Return parameter	Returns the trigger mode.	
Example	:TRIGger:MODE NORMal Sets the trigger mode to normal.	

3-14-7. :TRIGger:HOLDoff

Set →

→ Query

Description	Sets or queries the holdoff time.	
Syntax	:TRIGger:HOLDoff {<NRf> ?}	
Parameter	<NRf>	Holdoff time
Return parameter	<NR3>	Returns the trigger holdoff time.
Example	:TRIGger:HOLDoff 1.00E-8 Sets the trigger holdoff time to 10ns.	

3-14-8. :TRIGger:LEVel

Set →

→ Query

Description	Sets or queries the level.	
Syntax	:TRIGger:LEVel {TTL ECL SETTO50 <NRf> ?}	
Related commands	:TRIGger:TYPE	
Parameter	<NRf>	Trigger level value
	TTL	Sets the trigger level to TTL.
	ECL	Sets the trigger level to ECL.
	SETTO50	Sets the trigger level to the User level (50% by default).
Return parameter	<NR3>	Returns the trigger level.
Example1	:TRIGger:LEVel TTL Sets the trigger to TTL.	
Example2	:TRIGger:LEVel 3.30E-1 Sets the trigger level to 330mV/mA.	

3-14-9. :TRIGger:HLEVel

Set →

→ Query

Description	Sets or queries the high trigger level.	
Note	Applicable for Rise and Fall/Pulse Runt triggers.	
Syntax	:TRIGger:HLEVel {TTL ECL <NRf> ?}	
Related commands	:TRIGger:TYPe	
Parameter	<NRf>	High level value.
	TTL	Sets the high trigger level to TTL.
	ECL	Sets the high trigger level to ECL.
Return parameter	<NR3>	Returns the trigger high level.
Example1	:TRIGger:HLEVel TTL Sets the trigger high level to TTL.	
Example2	:TRIGger:HLEVel 3.30E-1 Sets the trigger high level to 330mV/mA.	

3-14-10. :TRIGger:LLEVel

Set →

→ Query

Description	Sets or queries the low trigger level.	
Note	Applicable for Rise and Fall/Pulse Runt triggers.	
Syntax	:TRIGger:LLEVel {TTL ECL <NRf> ?}	
Related commands	:TRIGger:TYPe	
Parameter	<NRf>	Low level value.
	TTL	Sets the low trigger level to TTL.
	ECL	Sets the log trigger level to ECL.
Return parameter	<NR3>	Returns the trigger low level.
Example1	:TRIGger:LLEVel TTL Sets the trigger low level to TTL.	
Example2	:TRIGger:LLEVel -3.30E-3 Sets the trigger low level to -330mV/mA.	

3-14-11. :TRIGger:EDGE:SLOP

Set →

→ Query

Description	Sets or queries the trigger slope.	
Syntax	:TRIGger:EDGE:SLOP {RISe FALL EITher ? }	
Related commands	:TRIGger:TYPE	
Parameter	RISe	Rising slope
	FALL	Falling slope
	EITher	Either rising or falling slope
Return parameter	Returns the trigger slope.	
Example	:TRIGger:EDGE:SLOP FALL Sets the trigger slope to falling.	

3-14-12. :TRIGger:DELAy:SLOP

Set →

→ Query

Description	Sets or queries the trigger slope for the delay trigger.	
Syntax	:TRIGger:DELAy:SLOP {RISe FALL EITher ? }	
Related commands	:TRIGger:TYPE	
Parameter	RISe	Rising slope
	FALL	Falling slope
	EITher	Either rising or falling slope
Return parameter	Returns the trigger slope.	
Example	:TRIGger:DELAy:SLOP FALL Sets the trigger slope to falling.	

3-14-13. :TRIGger:DELAy:TYPE

Set →

→ Query

Description	Sets or queries the trigger delay type.	
Syntax	:TRIGger:DELAy:TYPE {TIME EVENT ? }	
Related commands	:TRIGger:TYPE	
Parameter	TIME	Sets the delay type to time.
	EVENT	Sets the delay type to event.
Return parameter	Returns the trigger delay type.	
Example	:TRIGger:DELAy:TYPE TIME Sets the delay type to time delay.	

3-14-14. :TRIGger:DElay:TIME

Set →

→ Query

Description	Sets or queries the delay time value.
Syntax	:TRIGger:DElay:TIME {<NRf> ?}
Related commands	:TRIGger:DElay:TYPe
Parameter	<NRf> Delay time (1.00E-8~1.00E+1)
Return parameter	<NR3> Returns the delay time.
Example	:TRIGger:DElay:TIME 1.00E-6 Sets the delay time to 1us.

3-14-15. :TRIGger:DElay:EVENT

Set →

→ Query

Description	Sets or queries the number of events for the event delay trigger.
Syntax	:TRIGger:DElay:EVENT {<NR1> ?}
Related commands	:TRIGger:DElay:TYPe
Parameter	<NR1> 1~65535 events
Return parameter	<NR1> Returns the number of events.
Example	:TRIGger:DElay:EVENT 2 Sets the number of events to 2.

3-14-16. :TRIGger:DElay:LEVel

Set →

→ Query

Description	Sets or queries the trigger delay level.
Syntax	:TRIGger:DElay:LEVel {<NRf> ?}
Parameter	<NRf> Delay trigger level
Return parameter	<NR3> Returns the delay trigger.
Example	:TRIGger:DElay:LEVel 5.00E-3 Sets the delay trigger to 5mV/mA.

3-14-17. :TRIGger:PULSEWidth:POLarity

Set →

→ Query

Description	Sets or queries the pulse width trigger polarity.	
Syntax	:TRIGger:PULSEWidth:POLarity {POSitive NEGative ?}	
Related commands	:TRIGger:TYPE	
Parameter	POSitive	Positive polarity
	NEGative	Negative polarity
Return parameter	Returns the pulse width polarity.	
Example	:TRIGger:PULSEWidth:POLarity POSitive Sets the pulse width polarity to positive.	

3-14-18. :TRIGger:RUNT:POLarity

Set →

→ Query

Description	Sets or queries the Pulse Runt trigger polarity.	
Syntax	:TRIGger:RUNT:POLarity { POSitive NEGative EITher ? }	
Related commands	:TRIGger:TYPE	
Parameter	POSitive	Positive polarity
	NEGative	Negative polarity
	EITher	Positive or negative polarity
Return parameter	Returns the pulse runt trigger polarity.	
Example	:TRIGger:RUNT:POLarity POSitive Sets the Pulse Runt trigger polarity to positive.	

3-14-19. :TRIGger:RUNT:WHEn

Set →

→ Query

Description	Sets or queries the Pulse Runt trigger conditions.	
Syntax	:TRIGger:RUNT:WHEn {THAN LESSthan Equal UNEQual ? }	
Related commands	:TRIGger:TYPE :TRIGger:RUNT:TIME	
Parameter	THAN	>
	LESSthan	<
	Equal	=
	UNEQual	≠
Return parameter	Returns the pulse runt trigger condition.	
Example	:TRIGger:RUNT:WHEn UNEQual Sets the Pulse Runt trigger condition to unequal (≠).	

3-14-20. :TRIGger:RUNT:TIME

Set →

→ Query

Description	Sets or queries the Pulse Runt trigger time.	
Syntax	:TRIGger:RUNT:TIME {<NRf> ? }	
Related commands	:TRIGger:TYPE :TRIGger:RUNT:WHEN	
Parameter	<NRf>	Pulse runt time (4nS to 10S)
Return Parameter	<NR3>	Returns the runt time in seconds.
Example	:TRIGger:RUNT:TIME 4.00E-5 Sets the runt time to 40.0uS.	

3-14-21. :TRIGger:RISEFall:SLOP

Set →

→ Query

Description	Sets or queries the Rise & Fall slope.	
Syntax	:TRIGger:RISEFall:SLOP {RISe FALL EITHer ? }	
Parameter	RISe	Rising slope
	FALL	Falling slope
	EITHer	Either rising or falling slope
Return parameter	Returns the rise & fall slope.	
Example	:TRIGger:RISEFall:SLOP RISe Sets the Rise & Fall slope to rising.	

3-14-22. :TRIGger:RISEFall:WHEN

Set →

→ Query

Description	Sets or queries the rise/fall trigger conditions	
Syntax	:TRIGger:RISEFall:WHEN { THAN LESSthan Equal UNEQual ? }	
Related commands	:TRIGger:TYPE :TRIGger:RISEFall:TIME	
Parameter	THAN	>
	LESSthan	<
	Equal	=
	UNEQual	≠
Return parameter	Returns the rise/fall trigger condition.	
Example	:TRIGger:RISEFall:WHEN UNEQual Sets the Rise and Fall trigger condition to unequal (≠).	

3-14-23. :TRIGger:RISEFall:TIME

Set →

→ Query

Description	Sets or queries the Rise and Fall time.	
Syntax	:TRIGger:RISEFall:TIME {<NRf> ? }	
Related commands	:TRIGger:TYPE :TRIGger:RISEFall:WHEn	
Parameter	<NRf>	Rise and Fall time (4nS to 10S)
Return Parameter	<NR3>	Returns the rise and fall time in seconds.
Example	:TRIGger:RISEFall:TIME 4.00E-5 Sets the trigger rise & fall to 40.0us.	

3-14-24. :TRIGger:VIDeo:TYPE

Set →

→ Query

Description	Sets or queries the video trigger type.	
Syntax	:TRIGger:VIDeo:TYPE {NTSC PAL SECam EDTV480P EDTV576P HDTV720P HDTV1080I HDTV1080P ? }	
Related commands	:TRIGger:TYPE	
Parameter	NTSC	NTSC
	PAL	PAL
	SECam	SECAM
	EDTV480P	Extra definition TV 480P
	EDTV576P	Extra definition TV 576P
	HDTV720P	High definition TV 720P
	HDTV1080I	High definition TV 1080i
	HDTV1080P	High definition TV 1080P
Return parameter	Returns the video trigger type.	
Example	:TRIGger:VIDeo:TYPE NTSC Sets the video trigger to NTSC.	

3-14-25. :TRIGger:VIDeo:FIELD

Set →

→ Query

Description	Sets or queries the video trigger field.
Syntax	:TRIGger:VIDeo:FIELD { FIELD1 FIELD2 ALLFields ALLLines ? }
Related commands	:TRIGger:TYPE
Parameter	FIELD1 Trigger on field 1 FIELD2 Trigger on field 2 ALLFields Trigger on all fields ALLLines Trigger on all lines
Return parameter	Returns the video trigger field.
Example	:TRIGger:VIDeo:FIELD ALLFields Sets the video trigger to trigger on all fields.

3-14-26. :TRIGger:VIDeo:LINE

Set →

→ Query

Description	Sets or queries the video trigger line.
Syntax	:TRIGger:VIDeo:LINE {<NR1> ?}
Related commands	:TRIGger:TYPE
Parameter	<NR1> Video line
Return parameter	<NR3> Returns the video trigger line.
Example	:TRIGger:VIDeo:LINE 1 Sets the video trigger to line 1.

3-14-27. :TRIGger:VIDeo:POLarity

Set →

→ Query

Description	Sets or queries the video trigger polarity.
Syntax	:TRIGger:VIDeo:POLarity { POSitive NEGative ? }
Related commands	:TRIGger:TYPE
Parameter	POSitive Positive polarity NEGative Negative polarity
Return parameter	Returns the video trigger polarity.
Example	:TRIGger:VIDeo:POLarity POSitive Sets the video trigger polarity to positive.

3-14-28. :TRIGger:PULSe:WHEn

Set →

→ Query

Description	Sets or queries the pulse width trigger conditions.
Syntax	:TRIGger:PULSe:WHEn { THAN LESSthan Equal UNEQual ? }
Related commands	:TRIGger:TYPE :TRIGger:PULSe:TIME
Parameter	THAN > LESSthan < Equal = UNEQual ≠
Return parameter	Returns the pulse width trigger conditions.
Example	:TRIGger:PULSe:WHEn UNEQual Sets the trigger pulse width conditions to not equal to (≠).

3-14-29. :TRIGger:PULSe:TIME

Set →

→ Query

Description	Sets or queries the pulse width time.
Syntax	:TRIGger:PULSe:TIME {<NRf> ?}
Related commands	:TRIGger:TYPE :TRIGger:PULSe:WHEn
Parameter	<NRf> Pulse width time (4ns~10s)
Return parameter	<NR3> Returns the pulse width time in seconds.
Example	:TRIGger:PULSe:TIME 4.00E-5 Sets the trigger pulse width to 40.0us.

3-14-30. :TRIGger:TIMEOut:WHEn

Set →

→ Query

Description	Sets or queries the timeout trigger condition.
Syntax	:TRIGger:TIMEOut:WHEn {HIGH LOW EITHer ?}
Related commands	:TRIGger:TIMEOut:TIMER
Parameter	HIGH Signal is high. LOW Signal is low. EITHer Signal is high or low.
Return parameter	Returns the timeout condition (HIGH, LOW, EITHER).
Example1	:TRIGger:TIMEOut:WHEn LOW Sets the timeout condition to low.

3-14-31. :TRIGger:TIMEOut:TIMER

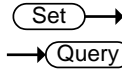

Description	Sets or returns timeout trigger time.
Syntax	:TRIGger:TIMEOut:TIMER {<NRf> ? }
Related commands	:TRIGger:TIMEOut:WHEN
Parameter	<NRf> Timeout time. (4nS to 10S).
Return parameter	Returns the timeout time as <NR3>.
Example	:TRIGger:TIMEOut:TIMER? 8.960e-05

3-14-32. :TRIGger:ALTErnate

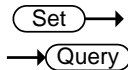

Description	Sets alternating between source triggers on or off or queries its state.
Syntax	:TRIGger:ALTErnate {OFF ON ?}
Parameter	OFF Alternate off ON Alternate on
Return parameter	Returns the Alternate trigger status (ON, OFF).
Example	:TRIGger:ALTErnate ON Turns on alternating between source triggers.

3-14-33. :TRIGger:STATe

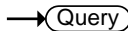

Description	Returns the current state of the triggering system.										
Syntax	:TRIGger:STATe?										
Return parameter	<table border="0"> <tr> <td>*ARMED</td> <td>Indicates that the oscilloscope is acquiring pretrigger information.</td> </tr> <tr> <td>*AUTO</td> <td>Indicates that the oscilloscope is in the automatic mode and acquires data even in the absence of a trigger.</td> </tr> <tr> <td>*READY</td> <td>Indicates that all pretrigger information has been acquired and that the oscilloscope is ready to accept a trigger.</td> </tr> <tr> <td>*SAVE</td> <td>Indicates that the oscilloscope is in save mode and is not acquiring data.</td> </tr> <tr> <td>*TRIGGER</td> <td>Indicates that the oscilloscope triggered and is acquiring the post trigger information.</td> </tr> </table>	*ARMED	Indicates that the oscilloscope is acquiring pretrigger information.	*AUTO	Indicates that the oscilloscope is in the automatic mode and acquires data even in the absence of a trigger.	*READY	Indicates that all pretrigger information has been acquired and that the oscilloscope is ready to accept a trigger.	*SAVE	Indicates that the oscilloscope is in save mode and is not acquiring data.	*TRIGGER	Indicates that the oscilloscope triggered and is acquiring the post trigger information.
*ARMED	Indicates that the oscilloscope is acquiring pretrigger information.										
*AUTO	Indicates that the oscilloscope is in the automatic mode and acquires data even in the absence of a trigger.										
*READY	Indicates that all pretrigger information has been acquired and that the oscilloscope is ready to accept a trigger.										
*SAVE	Indicates that the oscilloscope is in save mode and is not acquiring data.										
*TRIGGER	Indicates that the oscilloscope triggered and is acquiring the post trigger information.										
Example	:TRIGger:STATe? AUTO The trigger is in auto mode.										

3-14-34. :TRIGger:EXTERnal:PROBe:TYPe

Set →

→ Query

Description	Sets or queries the external probe type.
Syntax	:TRIGger:EXTERnal:PROBe:TYPe { VOLTage CURRent ? }
Related commands	:TRIGger:EXTERnal:PROBe:RATio
Parameter	VOLTage Voltage CURRent Current
Return parameter	Returns the probe type.
Example	:TRIGger:EXTERnal:PROBe:TYPe? CURRENT

3-14-35. :TRIGger:EXTERnal:PROBe:RATio

Set →

→ Query

Description	Sets or queries the external probe ratio (attenuation).
Syntax	:TRIGger:EXTERnal:PROBe:RATio {<NRf> ?}
Related commands	:TRIGger:EXTERnal:PROBe:TYPe
Parameter	<NRf> External probe attenuation factor.
Return parameter	<NR3> Returns the probe attenuation factor.
Example	:TRIGger:EXTERnal:PROBe:RATio? 5.000000e+01

3-14-36. :TRIGger:BUS:TYPe

→ Query

Description	Returns the current bus type.
Syntax	:TRIGger:BUS:TYPe?
Return parameter	I2C I2C mode SPI SPI mode UART UART mode PARALLEL Parallel mode
Example	:TRIGger:BUS:TYPe? UART

3-14-37. :TRIGger:BUS:THReshold:CH<x>

Set →

→ Query

Description	Sets or queries the threshold level for the selected channel.	
Syntax	:TRIGger:BUS:THReshold:CH<X> {<NR3> ?}	
	<X>	CH1 ~ CH4
	<NR3>	Threshold level
Return Parameter	<NR3>	Returns the threshold level
Example	:TRIGger:BUS:THReshold:CH1 1 Sets the CH1 threshold to 1V.	

3-14-38. :TRIGger:BUS:B1:I2C:CONDition

Set →

→ Query

Description	Sets or queries the I ² C trigger conditions.	
Syntax	:TRIGger:BUS:B1:I2C:CONDition {START STOP REPEATstart ACKMISS ADDRESS DATA ADDRANDDATA ? }	
Parameter	START	Set Start as the I ² C trigger condition.
	STOP	Set Stop as the I ² C trigger condition.
	REPEATstart	Set Repeat of Start as the I ² C trigger condition.
	ACKMISS	Set Missing Acknowledgement as the I ² C trigger condition.
	ADDRESS	Set Address as the I ² C trigger condition.
	DATA	Set Data as the I ² C trigger condition.
	ADDRANDDATA	Set Address and Data as the I ² C trigger condition.
Return parameter	Returns the I ² C bus trigger condition.	
Example	:TRIGger:BUS:B1:I2C:CONDition ADDRESS Set Address as the I2C trigger condition.	

3-14-39. :TRIGger:BUS:B1:I2C:ADDRess:MODE

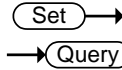

Description	Sets or queries the I ² C addressing mode (7 or 10 bits).	
Syntax	:TRIGger:BUS:B1:I2C:ADDRess:MODE {ADDR7 ADDR10 ?}	
Related commands	:TRIGger:BUS:B1:I2C:CONDition	
Parameter	ADDR7	7 bit addressing
	ADDR10	10 bit addressing
Return Parameter	0	7 bit addressing
	1	10 bit addressing
Example	:TRIGger:BUS:B1:I2C:ADDRess:MODE? 0 The addressing mode is current set to 7 bits.	

3-14-40. :TRIGger:BUS:B1:I2C:ADDRess:TYPE

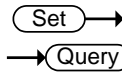

Description	Sets the I ² C bus address type, or queries what the setting is.	
Syntax	:TRIGger:BUS:B1:I2C:ADDRess:TYPE {GENERALcall STARTbyte HSmode EEPROM CBUS ?}	
Related commands	:TRIGger:BUS:B1:I2C:CONDition	
Parameter	GENERALcal	Set a general call address (0000 000 0).
	STARTbyte	Set a start byte address. (0000 000 1)
	HSmode	Set a high-speed mode address. (0000 1xx x)
	EEPROM	Set an EEPROM address. (1010 xxx x)
	CBUS	Set a CBUS address. (0000 001 x)
Return Parameter	Returns the address type	
Example	:TRIGger:BUS:B1:I2C:ADDRess:TYPE? CBUS	

3-14-41. :TRIGger:BUS:B1:I2C:ADDRess:VALue

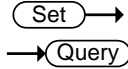

Description	Sets or queries the I ² C bus address value when the I ² C bus is set to trigger on Address or Address/Data.	
Syntax	:TRIGger:BUS:B1:I2C:ADDRess:VALue {string ? }	
Related commands	:TRIGger:BUS:B1:I2C:ADDRess:MODE	
Parameter	<string>	7/10 characters, must be enclosed in double quotes, "string". x = don't care 1 = binary 1 0 = binary 0
Return Parameter	Returns the address value.	
Example1	:TRIGger:BUS:B1:I2C:ADDRess:VALue "xxx0101" Sets the address to XXX0101	
Example 2	:TRIGger:BUS:B1:I2C:ADDRess:VALue? XXX0101	

3-14-42. :TRIGger:BUS:B1:I2C:ADDRess:DIRection

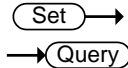

Description	Sets or queries the address bit as read write or don't care.	
Note	This setting only applies when the I ² C trigger is set to trigger on Address or Address/Data	
Syntax	:TRIGger:BUS:B1:I2C:ADDRess:DIRection { READ WRITE NOCARE ? }	
Related commands	:TRIGger:BUS:B1:I2C:CONDition	
Parameter	READ	Set read as the data direction.
	WRITE	Set write as the data direction.
	NOCARE	Set either as the data direction.
Return Parameter	Returns the direction (READ, WRITE, NOCARE).	
Example	:TRIGger:BUS:B1:I2C:ADDRess:DIRection READ Sets the direction to READ.	

3-14-43. :TRIGger:BUS:B1:I2C:DATA:SIZE

Set →

→ Query

Description	Sets or queries the data size in bytes for the I ² C bus.	
Note	This setting only applies when the I ² C trigger is set to trigger on Data or Address/Data	
Syntax	:TRIGger:BUS:B1:I2C:DATA:SIZE {<NR1> ? }	
Related commands	:TRIGger:BUS:B1:I2C:CONDition	
Parameter	<NR1>	Number of data bytes (1 to 5).
Return parameter	<NR1>	Returns the number of bytes.
Example	:TRIGger:BUS:B1:I2C:DATA:SIZE 3 Sets the number of bytes to 3.	

3-14-44. :TRIGger:BUS:B1:I2C:DATA:VALue

Set →

→ Query

Description	Sets or queries the triggering data value for the I ² C bus when the I ² C bus is set to trigger on Data or Address/Data.	
Syntax	:TRIGger:BUS:B1:I2C:DATA:VALue {string ? }	
Related commands	:TRIGger:BUS:B1:I2C:DATA:SIZE	
Parameter	<string>	The number of characters in the string depends on the data size setting. The string must be enclosed in double quotes, "string". x = don't care 1 = binary 1 0 = binary 0
Return Parameter	Returns the data value.	
Example1	:TRIGger:BUS:B1:I2C:DATA:SIZE 1 :TRIGger:BUS:B1:I2C:DATA:VALue "1x1x0101" Sets the value to XXX0101	
Example 2	:TRIGger:BUS:B1:I2C:DATA:VALue? 1X1X0101	

3-14-45. :TRIGger:BUS:B1:UART:CONDition

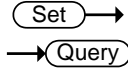

Description	Sets or queries the UART triggering condition.	
Syntax	:TRIGger:BUS:B1:UART:CONDition { RXSTART RXDATA RXENDPacket TXSTART TXDATA TXENDPacket TXPARItYerr RXPARItyerr ? }	
Parameter	RXSTART	Set trigger on the RX Start Bit.
	RXDATA	Set trigger on RX Data.
	RXENDPacket	Set trigger on the RX End of Packet condition.
	RXPARItyerr	Set trigger on RX Parity error condition.
	TXSTART	Set trigger on the TX Start Bit.
	TXDATA	Set trigger on TX Data.
	TXENDPacket	Set trigger on the TX End of Packet condition.
	TXPARItYerr	Set trigger on TX Parity error condition.
Return Parameter	Returns the triggering condition.	
Example	:TRIGger:BUS:B1:UART:CONDition TXDATA Sets the UART bus to trigger on Tx Data.	

3-14-46. :TRIGger:BUS:B1:UART:RX:DATA:SIZE

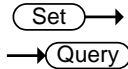

Description	Sets or queries the number of bytes for UART data.	
Note	This setting only applies when the UART trigger is set to trigger on Rx Data	
Syntax	:TRIGger:BUS:B1:UART:RX:DATA:SIZE {<NR1> ?}	
Related commands	:TRIGger:BUS:B1:UART:CONDition	
Parameter	<NR1>	Number of bytes (1 to 10).
Return parameter	<NR1>	Returns the number of bytes.
Example	:TRIGger:BUS:B1:UART:RX:DATA:SIZE 5 Sets the number of bytes to 5.	

3-14-47. :TRIGger:BUS:B1:UART:RX:DATA:VALue

Set →

→ Query

Description	Sets or queries the triggering data value for the UART bus when the bus is set to trigger on Rx Data.	
Syntax	:TRIGger:BUS:B1:UART:RX:DATA:VALue {string ? }	
Related commands	:TRIGger:BUS:B1:UART:RX:DATA:SIZE	
Parameter	<string>	The number of characters in the string depends on the data size setting. The string must be enclosed in double quotes, "string". x = don't care 1 = binary 1 0 = binary 0
Return Parameter	Returns the data value.	
Example1	:TRIGger:BUS:B1:UART:CONDition RXDATA :TRIGger:BUS:B1:UART:RX:DATA:SIZE 1 :TRIGger:BUS:B1:UART:RX:DATA:VALue "1x1x0101" Sets the value to 1x1x0101	
Example 2	:TRIGger:BUS:B1:UART:RX:DATA:VALue? 1X1X0101	

3-14-48. :TRIGger:BUS:B1:UART:TX:DATA:SIZE

Set →

→ Query

Description	Sets or queries the number of bytes for UART data.	
Note	This setting only applies when the UART trigger is set to trigger on Tx Data	
Syntax	:TRIGger:BUS:B1:UART:TX:DATA:SIZE <NR1> { ? }	
Related commands	:TRIGger:BUS:B1:UART:CONDition	
Parameter	<NR1>	Number of bytes (1 to 10).
Return parameter	<NR1>	Returns the number of bytes.
Example	:TRIGger:BUS:B1:UART:TX:DATA:SIZE 5 Sets the number of bytes to 5.	

3-14-49. :TRIGger:BUS:B1:UART:TX:DATA:VALue

Set →

→ Query

Description	Sets or queries the triggering data value for the UART bus when the bus is set to trigger on Tx Data.	
Syntax	:TRIGger:BUS:B1:UART:TX:DATA:VALue {string ? }	
Related commands	:TRIGger:BUS:B1:UART:TX:DATA:SIZE	
Parameter	<string>	The number of characters in the string depends on the data size setting. The string must be enclosed in double quotes, "string". x = don't care 1 = binary 1 0 = binary 0
Return Parameter	Returns the data value.	
Example1	:TRIGger:BUS:B1:UART:CONDition TXDATA :TRIGger:BUS:B1:UART:TX:DATA:SIZE 1 :TRIGger:BUS:B1:UART:TX:DATA:VALue "1x1x0101" Sets the value to 1x1x0101	
Example 2	:TRIGger:BUS:B1:UART:TX:DATA:VALue? 1X1X0101	

3-14-50. :TRIGger:BUS:B1:SPI:CONDition

Set →

→ Query

Description	Sets or queries the SPI triggering condition.	
Syntax	:TRIGger:BUS:B1:SPI:CONDition {SS MISO MOSI MISOMOSI ? }	
Parameter	SS	Set to trigger on the Slave Selection condition.
	MISO	Set to trigger on the Master-In Slave-Out condition.
	MOSI	Set to trigger on the Master-Out Slave-In condition.
	MISOMOSI	Set to trigger on the Master-In Slave-Out and Master-Out Slave-In conditions.
Return Parameter	Returns the triggering condition.	
Example	:TRIGger:BUS:B1:SPI:CONDition MISO Sets the SPI bus to trigger on MISO.	

3-14-51. :TRIGger:BUS:B1:SPI:DATA:SIZE

Set →

→ Query

Description	Sets or queries the number of words for SPI data.	
Note	This setting only applies when the SPI trigger is set to trigger on MISO, MOSI or MISO/MOSI	
Syntax	:TRIGger:BUS:B1:SPI:DATA:SIZE {<NR1> ?}	
Related commands	:TRIGger:BUS:B1:SPI:CONDition	
Parameter	<NR1>	Number of words (1 to 32).
Return parameter	<NR1>	Returns the number of words.
Example	:TRIGger:BUS:B1:SPI:DATA:SIZE 10 Sets the number of words to 10.	

3-14-52. :TRIGger:BUS:B1:SPI:DATA:MISO:VALue

Set →

→ Query

Description	Sets or queries the triggering data value for the SPI bus when the bus is set to trigger on MISO or MISO/MOSI.	
Syntax	:TRIGger:BUS:B1:SPI:DATA:MISO:VALue {string ?}	
Related commands	:TRIGger:BUS:B1:SPI:DATA:SIZE	
Parameter	<string>	The number of characters in the string depends on the data size setting. The string must be enclosed in double quotes, "string". x = don't care 1 = binary 1 0 = binary 0
Return Parameter	Returns the data value.	
Example1	:TRIGger:BUS:B1:SPI:CONDition MISO :TRIGger:BUS:B1:SPI:DATA:SIZE 2 :TRIGger:BUS:B1:SPI:DATA:MISO:VALue "1x1x0101" Sets the value to 1x1x0101	
Example 2	:TRIGger:BUS:B1:SPI:DATA:MISO:VALue? 1X1X0101	

3-14-53. :TRIGger:BUS:B1:SPI:DATA:MOSI:VALue

Set →

→ Query

Description	Sets or queries the triggering data value for the SPI bus when the bus is set to trigger on MOSI or MISO/MOSI.	
Syntax	:TRIGger:BUS:B1:SPI:DATA:MOSI:VALue {string ? }	
Related commands	:TRIGger:BUS:B1:SPI:DATA:SIZE	
Parameter	<string>	The number of characters in the string depends on the data size setting. The string must be enclosed in double quotes, "string". x = don't care 1 = binary 1 0 = binary 0
Return Parameter	Returns the data value.	
Example1	:TRIGger:BUS:B1:SPI:CONDition MOSI :TRIGger:BUS:B1:SPI:DATA:SIZE 2 :TRIGger:BUS:B1:SPI:DATA:MOSI:VALue "1x1x0101" Sets the value to 1x1x0101	
Example2	:TRIGger:BUS:B1:SPI:DATA:MOSI:VALue? 1X1X0101	

3-14-54. :TRIGger:BUS:B1:CAN:CONDition

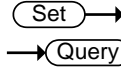

Description	Sets or returns the CAN trigger condition.	
Syntax	:TRIGger:BUS:B1:CAN:CONDition {SOF FRAMEtype Identifier DATA IDANDDATA EOF ACKMISS STUFFERR ?}	
Parameter/ Return parameter	SOF	Triggers on a start of frame
	FRAMEtype	Triggers on the type of frame
	Identifier	Triggers on a matching identifier
	DATA	Triggers on matching data
	IDANDDATA	Triggers on matching identifier and data field
	EOF	Triggers on the end of frame
	ACKMISS	Triggers on a missing acknowledge
	STUFFERR	Triggers on a bit stuffing error
Example1	:TRIGger:BUS:B1:CAN:CONDition SOF Triggers on a start of frame.	
Example2	:TRIGger:BUS:B1:CAN:CONDition? >SOF	

3-14-55. :TRIGger:BUS:B1:CAN:FRAMEType

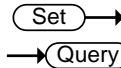

Description	Sets or returns the frame type for a CAN FRAMEType trigger.	
Syntax	:TRIGger:BUS:B1:CAN:FRAMEType {DATA REMote ERRor OVERLoad ?}	
Parameter/ Return parameter	DATA	Sets the frame type to data frame
	REMote	Sets the frame type to remote frame
	ERRor	Sets the frame type to error frame
	OVERLoad	Sets the frame type to overload
Example	:TRIGger:BUS:B1:CAN:FRAMEType DATA Sets the frame type to DATA.	

3-14-56. :TRIGger:BUS:B1:CAN:IDentifier:MODE

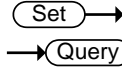

Description	Sets or returns the CAN addressing mode for the bus.	
Syntax	:TRIGger:BUS:B1:CAN:IDentifier:MODE {STANDard EXTended ?}	
Parameter/ Return parameter	STANDard EXTended	Standard addressing mode Extended addressing mode
Example	:TRIGger:BUS:B1:CAN:IDentifier:MODE? >STANDARD Returns the addressing mode.	

3-14-57. :TRIGger:BUS:B1:CAN:IDentifier:VALue

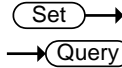

Description	Sets or returns the binary address string used for the CAN trigger. Note: Only applicable when the trigger condition is set to ID or IDANDDATA.	
Syntax	:TRIGger:BUS:B1:CAN:IDentifier:VALue {<string> ?}	
Related Commands	:TRIGger:BUS:B1:CAN:IDentifier:MODE	
Parameter/ Return parameter	<string>	The size of the string depends on the data size setting. The string must be enclosed in double quotes, "string". String contents: x = don't care 1 = binary 1 0 = binary 0
Example	:TRIGger:BUS:B1:CAN:CONDition ID :TRIGger:BUS:B1:CAN:IDentifier:MODE STANDARD :TRIGger:BUS:B1:CAN:IDentifier:VALue "01100X1X01X" :TRIGger:BUS:B1:CAN:IDentifier:VALue? >01100X1X01X	

3-14-58. :TRIGger:BUS:B1:CAN:IDentifier:DIRection

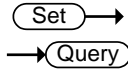

Description	Sets or queries the address bit as read, write or don't care.	
Syntax	:TRIGger:BUS:B1:CAN:IDentifier:DIRection {READ WRITE NOCARE ?}	
Parameter/ Return parameter	READ	Sets read as the data direction
	WRITE	Sets write as the data direction
	NOCARE	Sets either as the data direction
Example1	:TRIGger:BUS:B1:CAN:IDentifier:DIRection? >WRITE	
Example2	:TRIGger:BUS:B1:CAN:IDentifier:DIRection READ :TRIGger:BUS:B1:CAN:IDentifier:DIRection? > READ	

3-14-59. :TRIGger:BUS:B1:CAN:DATA:QUALifier

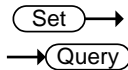

Description	Sets or returns the CAN data qualifier. Note: Only applicable when the triggering condition is set to DATA or IDANDDATA.	
Syntax	:TRIGger:BUS:B1:CAN:DATA:QUALifier {LESSthan THAN Equal UNEQual LESSEQual MOREEqual ?}	
Parameter/ Return parameter	LESSthan	Triggers when the data is less than the qualifier value.
	THAN	Triggers when the data is greater than the qualifier value.
	Equal	Triggers when the data is equal to the qualifier value.
	UNEQual	Triggers when the data is not equal to the qualifier value.
	LESSEQual	Triggers when the data is less than or equal to the qualifier value.
	MOREEqual	Triggers when the data is more than or equal to the qualifier value.
Example	:TRIGger:BUS:B1:CAN:DATA:QUALifier? >EQUAL :TRIGger:BUS:B1:CAN:DATA:QUALifier THAN :TRIGger:BUS:B1:CAN:DATA:QUALifier? >THAN	

3-14-60. :TRIGger:BUS:B1:CAN:DATA:SIZE

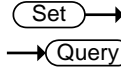

Description	Sets or returns the length of the data string in bytes for a CAN trigger. Note: Only applicable when the condition is set to DATA or IDANDDATA.
Syntax	:TRIGger:BUS:B1:CAN:DATA:SIZE {<NR1> ?}
Parameter/ Return parameter	<NR1> 1~8 (bytes)
Example	:TRIGger:BUS:B1:CAN:DATA:SIZE? >1 :TRIGger:BUS:B1:CAN:DATA:SIZE 2 :TRIGger:BUS:B1:CAN:DATA:SIZE? >2

3-14-61. :TRIGger:BUS:B1:CAN:DATA:VALue

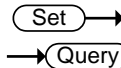

Description	Sets or returns the binary data string to be used for a CAN trigger. Note: Only applicable when the condition is set to DATA or IDANDDATA.
Related Commands	:TRIGger:BUS:B1:CAN:DATA:SIZE
Syntax	:TRIGger:BUS:B1:CAN:DATA:VALue {<string> ?}
Parameter/ Return parameter	<string> The size of the string depends on the data size setting. The string must be enclosed in double quotes, "string". String contents: x = don't care 1 = binary 1 0 = binary 0
Example	:TRIGger:BUS:B1:CAN:DATA:SIZE 1 :TRIGger:BUS:B1:CAN:DATA:VALue "01010X1X" :TRIGger:BUS:B1:CAN:DATA:VALue? >01010X1X

3-14-62. :TRIGger:BUS:B1:LIN:CONDition

Set →

→ Query

Description	Sets or returns the LIN trigger condition.	
Syntax	:TRIGger:BUS:B1:LIN:CONDition { {SYNCField IDentifier DATA IDANDDATA WAKEup SLEEp ERRor ?} }	
Parameter/ Return parameter	SYNCField	Sets the LIN trigger condition to the sync field.
	IDentifier	Sets the LIN trigger condition to identifier field.
	DATA	Sets the LIN trigger condition to the data field.
	IDANDDATA	Sets the LIN trigger condition to identifier and data field
	WAKEup	Sets the LIN trigger condition to wake up.
	SLEEp	Sets the LIN trigger condition to sleep.
	ERRor	Sets the LIN trigger condition to error.
Example	:TRIGger:BUS:B1:LIN:CONDition? >IDANDDATA :TRIGger:BUS:B1:LIN:CONDition DATA :TRIGger:BUS:B1:LIN:CONDition? >DATA	

3-14-63. :TRIGger:BUS:B1:LIN:DATA:QUALifier

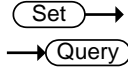

Description	Sets or returns the LIN data qualifier. Note: Only applicable when the trigger condition is set to DATA or IDANDDATA.	
Syntax	:TRIGger:BUS:B1:LIN:DATA:QUALifier {LESSthan THAN EQUAL UNEQUAL LESSEQUAL MOREEQUAL ?}	
Parameter/ Return parameter	LESSthan	Triggers when the data is less than the qualifier value.
	THAN	Triggers when the data is greater than the qualifier value.
	EQUAL	Triggers when the data is equal to the qualifier value.
	UNEQUAL	Triggers when the data is not equal to the qualifier value.
	LESSEQUAL	Triggers when the data is less than or equal to the qualifier value.
	MOREEQUAL	Triggers when the data is more than or equal to the qualifier value.
	LESSthan	Triggers when the data is less than the qualifier value.
Example	:TRIGger:BUS:B1:LIN:DATA:QUALifier? >EQUAL :TRIGger:BUS:B1:LIN:DATA:QUALifier THAN :TRIGger:BUS:B1:LIN:DATA:QUALifier? >THAN	

3-14-64. :TRIGger:BUS:B1:LIN:DATA:SIZE

Set →

→ Query

Description	Sets or returns the length of the data string in bytes for the LIN trigger. Note: Only applicable when the condition is set to DATA or IDANDDATA.
Syntax	:TRIGger:BUS:B1:LIN:DATA:SIZE {<NR1> ?}
Parameter/ Return parameter	<NR1> 1–8 (bytes)
Example	:TRIGger:BUS:B1:LIN:DATA:SIZE? >1 :TRIGger:BUS:B1:LIN:DATA:SIZE 2 :TRIGger:BUS:B1:LIN:DATA:SIZE? >2

3-14-65. :TRIGger:BUS:B1:LIN:DATA:VALue

Set →

→ Query

Description	Sets or returns the binary data string to be used for the LIN trigger. Note: Only applicable when the condition is set to DATA or IDANDDATA.
Related Commands	:TRIGger:BUS:B1:LIN:DATA:SIZE
Syntax	:TRIGger:BUS:B1:LIN:DATA:VALue {<string> ?}
Parameter/ Return parameter	<string> The size of the string depends on the data size setting. The string must be enclosed in double quotes, "string". String contents: x = don't care 1 = binary 1 0 = binary 0
Example	:TRIGger:BUS:B1:LIN:DATA:SIZE 1 :TRIGger:BUS:B1:LIN:DATA:VALue "01010X1X" :TRIGger:BUS:B1:LIN:DATA:VALue? >01010X1X

3-14-66. :TRIGger:BUS:B1:LIN:ERRTYPE

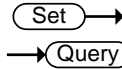

Description	Sets or returns the error type be used for the LIN trigger.	
Syntax	:TRIGger:BUS:B1:LIN:ERRTYPE {SYNC PARItY ChEcksum ?}	
Parameter/ Return parameter	SYNC	Sets the LIN error type to SYNC.
	PARItY	Sets the LIN error type to parity.
	ChEcksum	Sets the LIN error type to checksum.
Example	:TRIGger:BUS:B1:LIN:ERRTYPE? >SYNC :TRIGger:BUS:B1:LIN:ERRTYPE CHECKSUM :TRIGger:BUS:B1:LIN:ERRTYPE? >CHECKSUM	

3-14-67. :TRIGger:BUS:B1:LIN:IDentifier:VALue

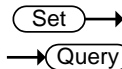

Description	Sets or returns the binary address string to be used for the LIN trigger. Note: Only applicable when the condition is set to DATA or IDANDDATA.	
Syntax	:TRIGger:BUS:B1:LIN:IDentifier:VALue {<string> ?}	
Parameter/ Return parameter	<string>	The size of the string depends on the data size setting. The string must be enclosed in double quotes, "string". String contents: x = don't care 1 = binary 1 0 = binary 0
Example	:TRIGger:BUS:B1:LIN:CONDition ID :TRIGger:BUS:B1:LIN:IDentifier:VALue "00X1X01X" :TRIGger:BUS:B1:LIN:IDentifier:VALue? >01100X1X01X	

3-15. System Commands
 3-15-1. :SYSTem:LOCK

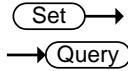

Description	Turns the panel lock on off.	
Syntax	:SYSTem:LOCK {OFF ON ? }	
Parameter	OFF	System lock off
	ON	System lock on
Return parameter	Returns the status of the panel lock (ON, OFF).	
Example	:SYSTem:LOCK ON Turns the panel lock on.	

3-15-2. :SYSTem:ERRor

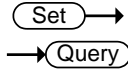

Description	Queries the error queue. See the appendix on page 177 for details.	
Syntax	:SYSTem:ERRor?	
Return parameter	Returns the last message in the error queue.	
Example	:SYSTem:ERRor? +0, "No error."	

3-15-3. :USBDelay

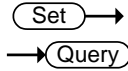

Description	Sets or returns the USB delay function for the PC connection which Windows 10 installed	
Syntax	:USBDelay {OFF ON} :USBDelay?	
Parameter/ Return parameter	<ON>	Turns on the USB delay function
	<OFF>	Turns off the USB delay function
Example	:USBDelay ON Turns on the USB delay function when the scope connected with window 10 installed PC..	

3-16. Save/Recall Commands

3-16-1. :RECALL:SETUp	111
3-16-2. :RECALL:WAVEform	111
3-16-3. :SAVe:IMAGe	111
3-16-4. :SAVe:IMAGe:FILEFormat	112
3-16-5. :SAVe:IMAGe:INKSaver	112
3-16-6. :SAVe:SETUp	112
3-16-7. :SAVe:WAVEform	114
3-16-8. :SAVe:WAVEform:FILEFormat	114

3-16-1. :RECALL:SETUp

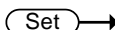

Description	Recalls setup settings from memory or USB.	
Syntax	:RECALL:SETUp {S1~S20 <file path>("Disk:/xxx.SET", "USB:/xxx.SET")}	
Parameter	S1~S20	Recall Set1~Set20
	<file path>	Recall a file from the DSO internal files system or from a USB flash drive.
Example	:RECALL:SETUp S1 Recalls setup setting S1 from memory. :RECALL:SETUp "Disk:/DS0001.SET" Recall setup setting DS0001.SET from system internal disk.	

3-16-2. :RECALL:WAVEform

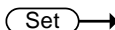

Description	Recalls a waveform from wave1~wave20 or from file to REF1~4.	
Note	Only *.LSF files can be recalled using this command. *.CSV files cannot be recalled.	
Syntax	:RECALL:WAVEform{W<n> <file path> ("Disk:/xxx.LSF", "USB:/xxx.LSF")}, REF<X>	
Parameter	n	1~20 (Wave1~wave20)
	xxx.LSF	Filename in file path.
	<X>	1,2,3,4 (REF1, REF2, REF3, REF4)
Example	:RECALL:WAVEform W1, REF1 Recalls the waveform stored in Wave1 to reference 1.	

3-16-3. :SAVe:IMAGe

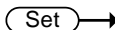

Description	Saves a screen image to the assigned file path with a specified filename.
Syntax	:SAVe:IMAGe {<file path> ("Disk:/xxx.PNG", "USB:/xxx.BMP")}

Related commands	:SAVE:IMAGe:FILEFormat :SAVE:IMAGe:INKSaver
Parameter	xxx.PNG or File name (8 characters max) xxx.BMP
Example	:SAVE:IMAGe "Disk:/pic1.PNG" Saves a screen image named pic1.png to the root directory (Disk:/) of the scope. :SAVE:IMAGe "USB:/pic1.BMP" Saves a screen image named pic1.bmp to the root directory of the external USB flash disk.

3-16-4. :SAVE:IMAGe:FILEFormat

Set →

→ Query

Description	Sets the file format for image.
Syntax	:SAVE:IMAGe:FILEFormat {PNG BMP ?}
Related commands	:SAVE:IMAGe :SAVE:IMAGe:INKSaver
Parameter	PNG Sets the file format to PNG BMP Sets the file format to BMP
Return parameter	Returns the file format (PNG, BMP).
Example	:SAVE:IMAGe:FILEFormat PNG Sets the image file format to PNG.

3-16-5. :SAVE:IMAGe:INKSaver

Set →

→ Query

Description	Turns Ink Saver on or off.
Syntax	:SAVE:IMAGe:INKSaver {OFF ON ?}
Related commands	:SAVE:IMAGe :SAVE:IMAGe:FILEFormat
Parameter	OFF Turns Inksaver off. ON Turns Inksaver on.
Return parameter	Returns Ink Saver status (ON, OFF).
Example	:SAVE:IMAGe:INKSaver ON Turns Ink Saver on.

3-16-6. :SAVE:SETUp

Set →

Description	Saves the current setup to internal memory (Set1~Set20) or the designated file path.
Syntax	:SAVE:SETUp {<file path> ("Disk:/xxx.SET", "USB:/xxx.SET) S1~S20}
Parameter	S1~S20 Saves the setup to Set1~Set20

File path	Saves the setup to disk to the specified file path.
-----------	---

Example

:SAVe:SETUp S1

Saves the current setup to Set1 in internal memory.

:SAVe:SETUp "Disk:/DS0001.SET"

Saves the current setup to DS0001.SET in the external USB flash disk.

3-16-7. :SAVe:WAVEform

(Set) →

Description	Saves a waveform to internal memory or to a designated file path.	
Syntax	:SAVe:WAVEform {CH1~REF4, REF<X> } {CH1~REF4, W1~W20} {CH1~ALL, file path}	
Parameter	CH1~REF4, <X> W1~W20 ALL File path	CH1~CH4, Math, REF1~4 1,2,3,4 (REF1, REF2, REF3, REF4) Wave1~Wave20 All the displayed waveforms on screen. Saves the waveform(s) to disk or USB to the specified file path.

Example
:SAVe:WAVEform CH1, REF2
Saves the channel1 waveform to REF2.
:SAVe:WAVEform ALL, "Disk:/ALL001"
Creates a folder which named "ALL001" and saves all displayed waveforms to the "ALL001" directory in the LSF format.
:SAVe:WAVEform ALL, "Disk:/ALL002"
Save the all channels waveform to the root directory (Disk:/) of the internal flash disk in the CSV format.
:SAVe:WAVEform CH2, "Disk:/DS0003.LSF"
Save the channel 2's waveform to the root directory (Disk:/) of the internal flash disk in the LSF format.

Note: Only LSF file format can be recalled by scope using remote commands.

3-16-8. :SAVe:WAVEform:FILEFormat

(Set) →

→ (Query)

Description	Sets the waveform savefile format.	
Syntax	:SAVe:WAVEform:FILEFormat {LSF DCSV FCSV ?}	
Parameter	LSF DCSV FCSV	Sets the file format to the DCS-1000B 's internal file format, LSF. (xxx.LSF)(no support LA) Sets the file format to detail CSV. (xxx.CSV) Sets the file format to fast CSV. (xxx.CSV)
Return parameter	Returns the file format	

Example
:SAVe:WAVEform:FILEFormat LSF
Sets the file format to LSF.

3-17. Ethernet Commands

3-17-1. :ETHERnet:DHCP

Set →

→ Query

Description	Sets or queries the DHCP settings.
Syntax	:ETHERnet:DHCP { OFF ON ? }
Parameter	ON Turns DHCP on. OFF Turns DHCP off.
Example	:ETHERnet:DHCP ON Turns DHCP on.

3-18. Bus Decode Commands

3-18-1. :BUS1	117
3-18-2. :BUS1:STATe	117
3-18-3. :BUS1:TYPe	117
3-18-4. :BUS1:INPut	117
3-18-5. :BUS1:I2C:ADDRess:RWINClude	118
3-18-6. :BUS1:I2C:SCLK:SOURce	118
3-18-7. :BUS1:I2C:SDA:SOURce	118
3-18-8. :BUS1:UART:BITRate	119
3-18-9. :BUS1:UART:DATABits	119
3-18-10. :BUS1:UART:PARITy	120
3-18-11. :BUS1:UART:PACKEt	120
3-18-12. :BUS1:UART:EOFPacket	120
3-18-13. :BUS1:UART:TX:SOURce	121
3-18-14. :BUS1:UART:RX:SOURce	121
3-18-15. :BUS1:SPI:SCLK:POLARITy	121
3-18-16. :BUS1:SPI:SS:POLARITy	122
3-18-17. :BUS1:SPI:WORDSize	122
3-18-18. :BUS1:SPI:BITORder	122
3-18-19. :BUS1:SPI:SCLK:SOURce	122
3-18-20. :BUS1:SPI:SS:SOURce	123
3-18-21. :BUS1:SPI:MOSI:SOURce	123
3-18-22. :BUS1:SPI:MISO:SOURce	123
3-18-23. :BUS1:DISPlay:FORMAt	124
3-18-24. :LISTer:DATA	124
3-18-25. :BUS1:CAN:SOURce	124
3-18-26. :BUS1:CAN:PROBe	125
3-18-27. :BUS1:CAN:SAMPLEpoint	125
3-18-28. :BUS1:CAN:BITRate	126
3-18-29. :BUS1:LIN:BITRate	126
3-18-30. :BUS1:LIN:IDFORmat	126
3-18-31. :BUS1:LIN:POLARITy	127
3-18-32. :BUS1:LIN:SAMPLEpoint	127
3-18-33. :BUS1:LIN:SOURce	127
3-18-34. :BUS1:LIN:STANDard	127

3-18-1. :BUS1

→ Query

Description	Returns the supported BUS types.
Syntax	:BUS1?
Return Parameter	Returns the supported bus types.
Example	BUS1? I2C,SPI,UART,CAN,LIN

3-18-2. :BUS1:STATE

Set →

→ Query

Description	Sets or queries the state of the bus.
Syntax	:BUS1:STATE { OFF ON ? }
Related commands	:BUS1:TYPe
Parameter/Return parameter	OFF Turns the bus off. ON Turns the bus on.
Example	:BUS1:STATE ON Turns the bus on.

3-18-3. :BUS1:TYPe

Set →

→ Query

Description	Sets or queries the type of bus.
Syntax	:BUS1:TYPe { UART I2C SPI CAN LIN? }
Related commands	:BUS1:STATE
Parameter/Return parameter	UART Sets the bus to UART mode. I2C Sets the bus to I ² C mode. SPI Sets the bus to SPI mode. CAN Sets the bus to CAN mode. LIN Sets the bus to LIN mode.
Example	:BUS1:TYPe SPI Sets the bus to SPI mode.

3-18-4. :BUS1:INPut

Set →

→ Query

Description	Sets or returns the analog source.
Syntax	:BUS1:INPut {ANALog ?}
Parameter/Return parameter	ANALog Sets the source to the analog inputs
Example1	:BUS1:INPut ANALog :BUS1:CAN:SOURce CH1

3-18-5. :BUS1:I2C:ADDRess:RWINClude

Set →

→ Query

Description	Sets or queries whether the read/write bit is included in the I ² C address.	
Syntax	:BUS1:I2C:ADDRess:RWINClude { OFF ON ? }	
Related commands	:BUS1:STATE	
Parameter	OFF	The R/W is not included.
	ON	The R/W is included.
Return parameter	0	The R/W is not included.
	1	The R/W is included.
Example	:BUS1:I2C:ADDRess:RWINClude ON Includes the R/W bit in the I ² C address.	

3-18-6. :BUS1:I2C:SCLK:SOURce

Set →

→ Query

Description	Sets or queries which channel is used for the I ² C SCLK source.	
Syntax	:BUS1:I2C:SCLK:SOURce { CH1 CH2 CH3 CH4 ? }	
Parameter/Return parameter	CH1 to CH4	Analog channels 1 ~ 4.
Example	:BUS1:I2C:SCLK:SOURce CH1 Sets channel CH1 as the SCLK source.	

3-18-7. :BUS1:I2C:SDA:SOURce

Set →

→ Query

Description	Sets or queries which channel is used for the I ² C SDA source.	
Syntax	:BUS1:I2C:SDA:SOURce { CH1 CH2 CH3 CH4 ? }	
Parameter/Return parameter	CH1 to CH4	Analog channels 1 ~ 4.
Example	:BUS1:I2C:SDA:SOURce CH1 Sets channel 1 as the SDA source.	

3-18-8. :BUS1:UART:BITRate

Set →

→ Query

Description	Sets or queries the UART bit rate.			
Syntax	:BUS1:UART:BITRate {<NR1> ? }			
Parameter/Return parameter	<NR1>	UART bit rate (0~31)		
	<NR1>	Rate (bps)	<NR1>	Rate (bps)
	0	50	16	15200
	1	75	17	19200
	2	110	18	28800
	3	134	19	31250
	4	150	20	38400
	5	300	21	56000
	6	600	22	57600
	7	1200	23	76800
	8	1800	24	115200
	9	2000	25	128000
	10	2400	26	230400
	11	3600	27	460800
	12	4800	28	921600
	13	7200	29	1382400
	14	9600	30	1843200
	15	14400	31	2764800

Example :BUS1:UART:BITRate 10
Sets the bit rate to 2400.

3-18-9. :BUS1:UART:DATABits

Set →

→ Query

Description	Sets or queries the number UART data for bus 1.		
Syntax	:BUS1:UART:DATABits { 5 6 7 8 9 ? }		
Parameter/Return parameter	5	5 data bits in the UART frame.	
	6	6 data bits in the UART frame.	
	7	7 data bits in the UART frame.	
	8	8 data bits in the UART frame.	

Example :BUS1:UART:DATABits 7
Sets the UART frame to 7 bits.

3-18-10. :BUS1:UART:PARItY

Set →
→ Query

Description	Sets or queries the UART bus parity.	
Syntax	:BUS1:UART:PARItY { <NR1> ? }	
Parameter/Return parameter	<NR1>	0: None 1: Odd parity 2: Even parity
Example	:BUS1:UART:PARItY 1 Sets the parity to odd.	

3-18-11. :BUS1:UART:PACKEt

Set →
→ Query

Description	Sets or queries the UART packet setting.	
Syntax	:BUS1:UART:PACKEt {<NR1> ? }	
Parameter/Return parameter	<NR1>	0: Off 1: On
Example	:BUS1:UART:PACKEt 1 Turns UART packets on.	

3-18-12. :BUS1:UART:EOFPACket

Set →
→ Query

Description	Sets or queries the EOF character for the UART packet setting.	
Syntax	:BUS1:UART:EOFPACket <NR1>	
Parameter/Return parameter	<NR1>	0: NULL 1: LF (line feed) 2: CR (carriage return) 3: SP (space character) 4: FF
Example	:BUS1:UART:EOFPACket 2 Sets the OEF character to CR.	

3-18-13. :BUS1:UART:TX:SOURce

Set →

→ Query

Description	Sets or queries which channel is used for the UART Tx source.	
Syntax	:BUS1:UART:TX:SOURce { OFF CH1 CH2 CH3 CH4 ? }	
Parameter/Return parameter	OFF CH1 to CH4	Off, no Tx source CH1 to CH4
Example	:BUS1:UART:TX:SOURce CH1 Sets channel 1 as the Tx source.	

3-18-14. :BUS1:UART:RX:SOURce

Set →

→ Query

Description	Sets or queries which channel is used for the UART Rx source.	
Syntax	:BUS1:UART:RX:SOURce { OFF CH1 CH2 CH3 CH4 ? }	
Parameter/Return parameter	OFF CH1 to CH4	Off, no Rx source CH1 to CH4
Example	:BUS1:UART:RX:SOURce CH1 Sets channel 1 as the Rx source.	

3-18-15. :BUS1:SPI:SCLK:POLARity

Set →

→ Query

Description	Sets or queries the polarity of the SCLK line for the SPI bus.	
Syntax	:BUS1:SPI:SCLK:POLARity { FALL RISE ? }	
Parameter/Return parameter	FALL RISE	Sets the polarity to falling edge. Sets the polarity to rising edge.
Example	:BUS1:SPI:SCLK:POLARity FALL Sets the polarity to falling edge.	

3-18-16. :BUS1:SPI:SS:POLARity

Set →

→ Query

Description	Sets or queries the polarity of the SS line for the SPI bus.	
Syntax	:BUS1:SPI:SS:POLARity { LOW HIGH ? }	
Parameter/Return parameter	LOW	Active low polarity
	HIGH	Active high polarity
Example	:BUS1:SPI:SS:POLARity LOW Sets the SS line to active low.	

3-18-17. :BUS1:SPI:WORDSize

Set →

→ Query

Description	Sets the number of bits per word for the SPI bus.	
Syntax	:BUS1:SPI:WORDSize { <NR1> ? }	
Parameter/Return parameter	<NR1>	Bits per word (4~32)
Example	:BUS1:SPI:WORDSize 4 Sets the word size to 4 bits per word.	

3-18-18. :BUS1:SPI:BITORder

Set →

→ Query

Description	Sets or queries the bit order for the SPI bus.	
Syntax	:BUS1:SPI:BITORder { <NR1> ? }	
Parameter/Return parameter	<NR1>	0: MSB bit first 1: LSB bit first
Example	:BUS1:SPI:BITORder? 0 The bit order is currently set as MSB bit first.	

3-18-19. :BUS1:SPI:SCLK:SOURce

Set →

→ Query

Description	Sets or queries which channel is used for the SPI SCLK source.	
Syntax	:BUS1:SPI:SCLK:SOURce { CH1 CH2 CH3 CH4 ? }	
Parameter/Return parameter	CH1 to CH4	CH1 to CH4
Example	:BUS1:SPI:SCLK:SOURce CH1 Sets channel 1 as the SPI SCLK source.	

3-18-20. :BUS1:SPI:SS:SOURce

Set →

→ Query

Description	Sets or queries which channel is used for the SPI SS source.	
Syntax	:BUS1:SPI:SS:SOURce { CH1 CH2 CH3 CH4 ? }	
Parameter/Return parameter	CH1 to CH4	CH1 to CH4
Example	:BUS1:SPI:SS:SOURce CH1 Sets channel 1 as the SPI SS source.	

3-18-21. :BUS1:SPI:MOSI:SOURce

Set →

→ Query

Description	Sets or queries which channel is used for the SPI MOSI source.	
Syntax	:BUS1:SPI:MOSI:SOURce { OFF CH1 CH2 CH3 CH4 ? }	
Parameter/Return parameter	CH1 to CH4 OFF	CH1 to CH4 No MOSI source.
Example	:BUS1:SPI:MOSI:SOURce CH1 Sets channel 1 as the SPI MOSI source.	

3-18-22. :BUS1:SPI:MISO:SOURce

Set →

→ Query

Description	Sets or queries which channel is used for the SPI MISO source.	
Syntax	:BUS1:SPI:MISO:SOURce { OFF CH1 CH2 CH3 CH4 ? }	
Parameter/Return parameter	CH1 to CH4 OFF	CH1 to CH4 No MISO source.
Example	:BUS1:SPI:MISO:SOURce CH1 Sets channel CH1 as the SPI MISO source.	

3-18-23. :BUS1:DISplay:FORMAt

Set →

→ Query

Description	Sets or queries the display format for the bus, either binary or hexadecimal.
Syntax	:BUS1:DISplay:FORMAt { BINary HEXadecimal ? }
Parameter/Return parameter	BINary Binary format HEXadecimal Hexadecimal format
Example	: BUS1:DISplay:FORMAt BINary Sets the display format to binary.

3-18-24. :LISTer:DATA

→ Query

Description	Returns the Event Table data as the CSV data.
Syntax	:LISTer:DATA?
Return parameter	Returns the event table as the CSV data. The data contains comma separated data with new lines at the end of each row.

3-18-25. :BUS1:CAN:SOURce

Set →

→ Query

Description	Sets or returns the CAN input source.
Syntax	:BUS1:CAN:SOURce { CH1 CH2 CH3 CH4 ? }
Parameter/Return parameter	CH1 ~ CH4 Analog channel source
Example	:BUS1:CAN:SOURCE? >CH1 Returns the CAN source.

3-18-26. :BUS1:CAN:PROBe

Set →

→ Query

Description	Sets or returns the signal type of the CAN bus.	
Syntax	:BUS1:CAN:PROBe {CANH CANL TX RX ? }	
Parameter/Return parameter	CANH	CAN-High
	CANL	CAN-Low
	TX	Transmit
	RX	Receive
Example	:BUS1:CAN:PROBe? >CANH :BUS1:CAN:PROBe CANL :BUS1:CAN:PROBe? >CANL	

3-18-27. :BUS1:CAN:SAMPLEpoint

→ Query

Description	Returns the sample point of the CAN bus.	
Syntax	:BUS1:CAN:SAMPLEpoint?	
Return Parameter	Returns the sample point of the CAN bus as a percentage of the bit time.	
Example	:BUS1:CAN:SAMPLEpoint? 50 Returns the sample point as a percentage.	

3-18-28. :BUS1:CAN:BITRate

Set →

→ Query

Description	Sets or returns the bit rate of the CAN bus.	
Syntax	:BUS1:CAN:BITRate {RATE10K RATE20K RATE50K RATE125K RATE250K RATE500K RATE800K RATE1M ?}	
Parameter/Return parameter	RATE10K	10 kbps
	RATE20K	20 kbps
	RATE50K	50 kbps
	RATE125K	125 kbps
	RATE250K	250 kbps
	RATE500K	500 kbps
	RATE800K	800 kbps
	RATE1M	1 Mbps
Example	:BUS1:CAN:BITRate? >RATE250K :BUS1:CAN:BITRate rate10k :BUS1:CAN:BITRate? >RATE10K	

3-18-29. :BUS1:LIN:BITRate

Set →

→ Query

Description	Sets or returns the bit rate of the LIN bus.	
Syntax	:BUS1:LIN:BITRate {<NR1> ?}	
Parameter/Return parameter	<NR1>	1200, 2400, 4800, 9600, 10417, 19200
Example	:BUS1:LIN:BITRate 9600 Sets the LIN bit rate to 9600 bps.	

3-18-30. :BUS1:LIN:IDFormat

Set →

→ Query

Description	Sets or returns the LIN ID format.	
Syntax	:BUS1:LIN:IDFormat {NOPARity PARity ?}	
Parameter/Return parameter	NOPARity	No parity
	PARity	Parity
Example	:BUS1:LIN:IDFormat? NOPARITY Returns the ID format.	

3-18-31. :BUS1:LIN:POLARity

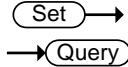

Description	Sets or returns the LIN polarity.	
Syntax	:BUS1:LIN:POLARity {NORMal INVerted ?}	
Parameter/Return parameter	NORMal	Normal LIN polarity
	INVerted	Inverted LIN polarity
Example	:BUS1:LIN:POLARity? NORMAL Returns the LIN polarity.	

3-18-32. :BUS1:LIN:SAMPLEpoint



Description	Returns the sample point of the LIN bus.	
Syntax	:BUS1:LIN:SAMPLEpoint?	
Return Parameter	Returns the sample point of the LIN bus as a percentage of the bit rate.	
Example	:BUS1:LIN:SAMPLEpoint? 50 Returns the sample point as a percentage.	

3-18-33. :BUS1:LIN:SOURce

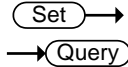

Description	Sets or returns the LIN data source.	
Syntax	:BUS1:LIN:SOURce {CH1 CH2 CH3 CH4 ? }	
Parameter/Return parameter	CH1 ~ CH4	Analog channel source
Example	:BUS1:LIN:SOURCE? >CH1 Returns the LIN source.	

3-18-34. :BUS1:LIN:STANDard

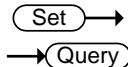

Description	Sets or returns the LIN standard.	
Syntax	:BUS1:LIN:STANDard {V1X V2X BOTH ?}	
Parameter/Return parameter	V1X	Lin standard version 1.x
	V2X	Lin standard version 2.x
	BOTH	Both standards
Example	:BUS1:LIN:STANDard? >BOTH Returns the LIN standard.	

3-19. Mark Commands

3-19-1. :MARK	128
3-19-2. :MARK:CREATE	128
3-19-3. :MARK:DELEte	128

3-19-1. :MARK

(Set) →

Description	Move to next or previous event mark.
Syntax	:MARK { NEXT PREVIOUS }
Related commands	:MARK:CREATE :MARK:DELEte
Parameter	NEXT Move to next mark PREVIOUS Move to previous mark
Example	:MARK NEXT Moves to the next event mark.

3-19-2. :MARK:CREATE

(Set) →

Description	Creates a mark on the waveform at the current position or creates a mark for all the events for the current waveform.
Syntax	:MARK:CREATE { CURRENT ALL }
Related commands	:MARK :MARK:DELEte
Parameter	CURRENT Creates a mark at the current position ALL Creates a mark for all the events.
Example	:MARK:CREATE CURRENT Creates a mark at the current position.

3-19-3. :MARK:DELEte

(Set) →

Description	Deletes the current mark or all the marks on a waveform.
Syntax	:MARK:DELEte { CURRENT ALL }
Related commands	:MARK :MARK:CREATE
Parameter	CURRENT Deletes the current mark ALL Deletes all the marks.
Example	:MARK:DELEte CURRENT Deletes the current mark.

3-20. Search Commands

3-20-1. :SEARCH:COpy	130
3-20-2. :SEARCH:STATE	130
3-20-3. :SEARCH:TOTAL	130
3-20-4. :SEARCH:TRIGger:TYPe	131
3-20-5. :SEARCH:TRIGger:SOURce	131
3-20-6. :SEARCH:TRIGger:EDGE:SLOP	131
3-20-7. :SEARCH:TRIGger:LEVel	132
3-20-8. :SEARCH:TRIGger:HLEVel	132
3-20-9. :SEARCH:TRIGger:LLEVel	133
3-20-10. :SEARCH:TRIGger:PULSEWidth:POLarity	133
3-20-11. :SEARCH:TRIGger:RUNT:POLarity	133
3-20-12. :SEARCH:TRIGger:RISEFall:SLOP	134
3-20-13. :SEARCH:TRIGger:PULSe:WHEn	134
3-20-14. :SEARCH:TRIGger:PULSe:TIME	135
3-20-15. :SEARCH:TRIGger:RUNT:WHEn	135
3-20-16. :SEARCH:TRIGger:RUNT:TIME	135
3-20-17. :SEARCH:TRIGger:RISEFall:WHEn	136
3-20-18. :SEARCH:TRIGger:RISEFall:TIME	136
3-20-19. :SEARCH:TRIGger:BUS:TYPe	136
3-20-20. :SEARCH:TRIGger:BUS:B1:I2C:CONDition	137
3-20-21. :SEARCH:TRIGger:BUS:B1:I2C:ADDRess:MODE	137
3-20-22. :SEARCH:TRIGger:BUS:B1:I2C:ADDRess:TYPe	138
3-20-23. :SEARCH:TRIGger:BUS:B1:I2C:ADDRess:VALue	138
3-20-24. :SEARCH:TRIGger:BUS:B1:I2C:ADDRess:DIRectioN	139
3-20-25. :SEARCH:TRIGger:BUS:B1:I2C:DATA:SIZE	139
3-20-26. :SEARCH:TRIGger:BUS:B1:I2C:DATA:VALue	140
3-20-27. :SEARCH:TRIGger:BUS:B1:UART:CONDition	141
3-20-28. :SEARCH:TRIGger:BUS:B1:UART:RX:DATA:SIZE	141
3-20-29. :SEARCH:TRIGger:BUS:B1:UART:RX:DATA:VALue	142
3-20-30. :SEARCH:TRIGger:BUS:B1:UART:TX:DATA:SIZE	142
3-20-31. :SEARCH:TRIGger:BUS:B1:UART:TX:DATA:VALue	143
3-20-32. :SEARCH:TRIGger:BUS:B1:SPI:CONDition	143
3-20-33. :SEARCH:TRIGger:BUS:B1:SPI:DATA:SIZE	144
3-20-34. :SEARCH:TRIGger:BUS:B1:SPI:DATA:MISO:VALue	144
3-20-35. :SEARCH:TRIGger:BUS:B1:SPI:DATA:MOSI:VALue	145
3-20-36. :SEARCH:TRIGger:BUS:B1:CAN:CONDition	146
3-20-37. :SEARCH:TRIGger:BUS:B1:CAN:FRAMeTYpe	146
3-20-38. :SEARCH:TRIGger:BUS:B1:CAN:IDentifier:MODE	147
3-20-39. :SEARCH:TRIGger:BUS:B1:CAN:IDentifier:VALue	147
3-20-40. :SEARCH:TRIGger:BUS:B1:CAN:IDentifier:DIRectioN	148
3-20-41. :SEARCH:TRIGger:BUS:B1:CAN:DATA:QUALifier	149
3-20-42. :SEARCH:TRIGger:BUS:B1:CAN:DATA:SIZE	149
3-20-43. :SEARCH:TRIGger:BUS:B1:CAN:DATA:VALue	150
3-20-44. :SEARCH:TRIGger:BUS:B1:LIN:CONDition	151
3-20-45. :SEARCH:TRIGger:BUS:B1:LIN:DATA:QUALifier	152
3-20-46. :SEARCH:TRIGger:BUS:B1:LIN:DATA:SIZE	153
3-20-47. :SEARCH:TRIGger:BUS:B1:LIN:DATA:VALue	153
3-20-48. :SEARCH:TRIGger:BUS:B1:LIN:ERRTYPE	154
3-20-49. :SEARCH:TRIGger:BUS:B1:LIN:IDentifier:VALue	154
3-20-50. :SEARCH:FFTPeak:METhod	155
3-20-51. :SEARCH:FFTPeak:METhod:MPeak	155

3-20-1. :SEARCH:COPY

Set →

Description	Copies the search settings to the trigger settings or copies the trigger settings to the search settings.	
Syntax	:SEARCH:COPY {SEARCHtotrigger TRIGgertosearch}	
Parameter	SEARCHtotrigger	Copy the search setting to the trigger settings.
	TRIGgertosearch	Copy the trigger settings to the search settings.
Example	:SEARCH:COPY SEARCHtotrigger Copies the search settings to the trigger settings.	

3-20-2. :SEARCH:STATE

Set →

→ Query

Description	Sets or queries whether the Search function is on or off.	
Syntax	:SEARCH:STATE { OFF ON ? }	
Parameter/	OFF	Turn the Search function on.
Return parameter	ON	Turn the Search function off.
Example	:SEARCH:STATE ON Turn Search on.	

3-20-3. :SEARCH:TOTAL

→ Query

Description	Returns the total number of events found from the search function.	
Syntax	:SEARCH:TOTAL?	
Parameter	<NR1>	Number of events.
Example	:SEARCH:TOTAL? 5	

3-20-4. :SEARCH:TRIGger:TYPE

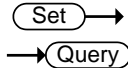

Description	Sets or queries the search trigger type.	
Syntax	:SEARCH:TRIGger:TYPE { EDGe PULSEwidth RUnt RISEFall BUS ? }	
Parameter/Return parameter	EDGE	Edge trigger
	PULSEwidth	Pulse width trigger
	RUnt	Runt trigger
	RISEFall	Rise and Fall trigger
	BUS	Bus trigger
Example	:SEARCH:TRIGger:TYPE EDGE Sets the search trigger to the edge type.	

3-20-5. :SEARCH:TRIGger:SOURce

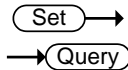

Description	Sets or queries the search trigger source.	
Syntax	:SEARCH:TRIGger:SOURce {CH1 CH2 CH3 CH4 ? }	
Parameter/Return parameter	CH1 to CH4	Channel 1 to Channel 4
Example	:SEARCH:TRIGger:SOURce CH1 Sets the search trigger source as CH1.	

3-20-6. :SEARCH:TRIGger:EDGE:SLOP

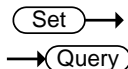

Description	Sets or queries the search trigger slope.	
Syntax	:SEARCH:TRIGger:EDGE:SLOP { RISE FALL EITHER ? }	
Related commands	:SEARCH:TRIGger:TYPE	
Parameter	RISE	Rising slope
	FALL	Falling slope
	EITHER	Either rising or falling slope
Return parameter	Returns the trigger slope.	
Example	:SEARCH:TRIGger:EDGE:SLOP FALL Sets the search trigger slope to falling.	

3-20-7. :SEARCH:TRIGger:LEVel

Set →

→ Query

Description	Sets or queries the search trigger level.	
Syntax	:SEARCH:TRIGger:LEVel {TTL ECL SETTO50 <NRf> ?}	
Related commands	:SEARCH:TRIGger:TYPE	
Parameter	<NRf>	Trigger level value
	TTL	Sets the search trigger level to TTL.
	ECL	Sets the search trigger level to ECL.
	SETTO50	Sets the search trigger level to the User level (50% by default).
Return parameter	<NR3>	Returns the trigger.
Example1	:SEARCH:TRIGger:LEVel TTL Sets the search trigger level to TTL.	
Example2	:SEARCH:TRIGger:LEVel 3.30E-1 Sets the search trigger level to 330mV/mA.	

3-20-8. :SEARCH:TRIGger:HLEVel

Set →

→ Query

Description	Sets or queries the high level search trigger.	
Note	Applicable for Rise and Fall/Pulse Runt search triggers.	
Syntax	:SEARCH:TRIGger:HLEVel {TTL ECL <NRf> ?}	
Related commands	:SEARCH:TRIGger:TYPE	
Parameter	<NRf>	High level value.
	TTL	Sets the high level search trigger to TTL.
	ECL	Sets the high level search trigger to ECL.
Return parameter	<NR3>	Returns the high level search trigger.
Example1	:SEARCH:TRIGger:HLEVel TTL Sets the high level search trigger to TTL	
Example2	:SEARCH:TRIGger:HLEVel 3.30E-1 Sets the high level search trigger to 330mV/mA.	

3-20-9. :SEARCH:TRIGger:LLEVel

Set →

→ Query

Description	Sets or queries the low level search trigger.	
Note	Applicable for Rise and Fall/Pulse Runt triggers.	
Syntax	:SEARCH:TRIGger:LLEVel {TTL ECL <NRf> ?}	
Related commands	:SEARCH:TRIGger:TYPE	
Parameter	<NRf>	Low level value.
	TTL	Sets the low trigger level to TTL.
	ECL	Sets the low trigger level to ECL.
Return parameter	<NR3>	Returns the low level.
Example	:SEARCH:TRIGger:LLEVel TTL Sets the low level search trigger to TTL.	
Example	:SEARCH:TRIGger:LLEVel -3.30E-3 Sets the low level search trigger to 330mV/mA.	

3-20-10. :SEARCH:TRIGger:PULSEWidth:POLarity

Set →

→ Query

Description	Sets or queries the pulse width search trigger polarity.	
Syntax	:SEARCH:TRIGger:PULSEWidth:POLarity {POSitive NEGative ?}	
Related commands	:SEARCH:TRIGger:TYPE	
Parameter	POSitive	Positive polarity
	NEGative	Negative polarity
Return parameter	Returns the pulse width polarity.	
Example	:SEARCH:TRIGger:PULSEWidth:POLarity POSitive Sets the pulse width polarity to positive.	

3-20-11. :SEARCH:TRIGger:RUNT:POLarity

Set →

→ Query

Description	Sets or queries the Pulse Runt search trigger polarity.	
Syntax	:SEARCH:TRIGger:RUNT:POLarity {POSitive NEGative EITHER ?}	
Related commands	:SEARCH:TRIGger:TYPE	
Parameter	POSitive	Positive polarity
	NEGative	Negative polarity
	EITHER	Positive or negative polarity
Return parameter	Returns the pulse runt search trigger polarity.	
Example	:SEARCH:TRIGger:RUNT:POLarity POSitive Sets the Pulse Runt search trigger polarity to positive.	

3-20-12. :SEARCH:TRIGger:RISEFall:SLOP

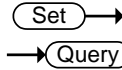

Description	Sets or queries the slope of the Rise and Fall search trigger.	
Syntax	:SEARCH:TRIGger:RISEFall:SLOP { RISE FALL EITHER ? }	
Related commands	:SEARCH:TRIGger:TYPE	
Parameter	RISE	Rising slope
	FALL	Falling slope
	EITHER	Either rising or falling slope
Return parameter	Returns the rise & fall slope.	
Example	:SEARCH:TRIGger:RISEFall :SLOP RISE Sets the Rise & Fall search trigger slope to rising.	

3-20-13. :SEARCH:TRIGger:PULSE:WHEN

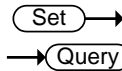

Description	Sets or queries the pulse width search trigger conditions.	
Syntax	:SEARCH:TRIGger:PULSE:WHEN {THAN LESSthan EQUAL UNEQUAL ?}	
Related commands	:SEARCH:TRIGger:TYPE :SEARCH:TRIGger:PULSE:TIME	
Parameter	THAN	>
	LESSthan	<
	EQUAL	=
	UNEQUAL	≠
Return parameter	Returns the pulse width search trigger conditions.	
Example	:SEARCH:TRIGger:PULSE:WHEN UNEQUAL Sets the pulse width search trigger conditions to not equal to (≠).	

3-20-14. :SEARCH:TRIGger:PULSe:TIME

Set →

→ Query

Description	Sets or queries the pulse width search trigger time.	
Syntax	:SEARCH:TRIGger:PULSe:TIME {<NRf> ? }	
Related commands	:SEARCH:TRIGger:TYPe :SEARCH:TRIGger:PULSe:WHEn	
Parameter	<NRf>	Pulse width time (4ns~10s)
Return parameter	<NR3>	Returns the pulse width time in seconds.
Example	:SEARCH:TRIGger:PULSe:TIME 4.00E-5 Sets the pulse width search trigger to 40.0us.	

3-20-15. :SEARCH:TRIGger:RUNT:WHEn

Set →

→ Query

Description	Sets or queries the pulse runt search trigger conditions.	
Syntax	:SEARCH:TRIGger:RUNT:WHEn {THAN LESSthan Equal UNEQual ? }	
Related commands	:SEARCH:TRIGger:TYPe :SEARCH:TRIGger:RUNT:TIME	
Parameter	THAN	>
	LESSthan	<
	Equal	=
	UNEQual	≠
Return parameter	Returns the pulse runt search trigger conditions.	
Example	:SEARCH:TRIGger:RUNT:WHEn UNEQual Sets the pulse runt search trigger condition to unequal (≠).	

3-20-16. :SEARCH:TRIGger:RUNT:TIME

Set →

→ Query

Description	Sets or queries the pulse runt search trigger time.	
Syntax	:SEARCH:TRIGger:RUNT:TIME {<NRf> ? }	
Related commands	:SEARCH:TRIGger:TYPe :SEARCH:TRIGger:RUNT:WHEn	
Parameter	<NRf>	Pulse runt time (4nS to 10S)
Return Parameter	<NR3>	Returns the runt time in seconds.
Example	:SEARCH:TRIGger:RUNT:TIME 4.00E-5 Sets the pulse runt time to 40.0uS.	

3-20-17. :SEARCH:TRIGger:RISEfall:WHEN

Set →

→ Query

Description	Sets or queries the rise and fall search trigger conditions.
Syntax	:SEARCH:TRIGger:RISEfall:WHEN {THAN LESSthan EQual UNEQual ? }
Related commands	:SEARCH:TRIGger:TYPE :SEARCH:TRIGger:RISEfall:TIME
Parameter	THAN > LESSthan < Equal = UNEQual ≠
Return parameter	Returns the rise and fall search trigger condition.
Example	:SEARCH:TRIGger:RISEfall:WHEN UNEQual Sets the rise andfall search trigger condition to unequal (≠).

3-20-18. :SEARCH:TRIGger:RISEfall:TIME

Set →

→ Query

Description	Sets or queries the rise and fall time.
Syntax	:SEARCH:TRIGger:RISEfall:TIME {<NRf> ? }
Related commands	:SEARCH:TRIGger:TYPE :SEARCH:TRIGger:RISEfall:WHEN
Parameter	<NRf> Rise and Fall time (4nS to 10S)
Return Parameter	<NR3> Returns the rise and fall time in seconds.
Example	:SEARCH:TRIGger:RISEfall:TIME 4.00E-5 Sets the trigger rise and fall time to 40.0us.

3-20-19. :SEARCH:TRIGger:BUS:TYPE

→ Query

Description	Returns the current bus type.
Syntax	:SEARCH:TRIGger:BUS:TYPE?
Return parameter	12C I2C mode SPI SPI mode UART UART mode CAN CAN mode LIN LIN mode
Example	:SEARCH:TRIGger:BUS:TYPE? UART

3-20-20. :SEARCH:TRIGger:BUS:B1:I2C:CONDition

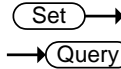

Description	Sets or queries the I ² C search trigger conditions.	
Syntax	:SEARCH:TRIGger:BUS:B1:I2C:CONDition {START STOP REPEATstart ACKMISS ADDRess DATA ADDRANDDATA ? }	
Parameter	START	Set Start as the I ² C search trigger condition.
	STOP	Set Stop as the I ² C search trigger condition.
	REPEATstart	Set Repeat of Start as the I ² C search trigger condition.
	ACKMISS	Set Missing Acknowledgement as the I ² C search trigger condition.
	ADDRess	Set Address as the I ² C search trigger condition.
	DATA	Set Data as the I ² C search trigger condition.
	ADDRANDDATA	Set Address and Data as the I ² C search trigger condition.
Return parameter	Returns the I ² C bus search trigger condition.	
Example	:SEARCH:TRIGger:BUS:B1:I2C:CONDition ADDRess Set Address as the I ² C search trigger condition.	

3-20-21. :SEARCH:TRIGger:BUS:B1:I2C:ADDRess:MODE

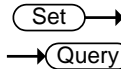

Description	Sets or queries the I ² C addressing mode (7 or 10 bits) for the search trigger.	
Syntax	:SEARCH:TRIGger:BUS:B1:I2C:ADDRess:MODE {ADDR7 ADDR10 ? }	
Related commands	:SEARCH:TRIGger:BUS:B1:I2C:CONDition	
Parameter	ADDR7	7 bit addressing
	ADDR10	10 bit addressing
Return Parameter	0	7 bit addressing
	1	10 bit addressing
Example	:SEARCH:TRIGger:BUS:B1:I2C:ADDRess:MODE? 0 The addressing mode is current set to 7 bits.	

3-20-22. :SEARCH:TRIGger:BUS:B1:I2C:ADDRess:TYPE

Set →

→ Query

Description	Sets the I ² C bus address type, or queries what the setting is for the search trigger.	
Syntax	:SEARCH:TRIGger:BUS:B1:I2C:ADDRess:TYPE {GENeralcall STARtbyte HSmode EEPROM CBUS ?}	
Related commands	:SEARCH:TRIGger:BUS:B1:I2C:CONDition	
Parameter	GENeralcall	Set a general call address (0000 000 0).
	STARtbyte	Set a start byte address. (0000 000 1)
	HSmode	Set a high-speed mode address. (0000 1xx x)
	EEPROM	Set an EEPROM address. (1010 xxx x)
	CBUS	Set a CBUS address. (0000 001 x)
Return Parameter	Returns the address type	
Example	:SEARCH:TRIGger:BUS:B1:I2C:ADDRess:TYPE? CBUS	

3-20-23. :SEARCH:TRIGger:BUS:B1:I2C:ADDRess:VALue

Set →

→ Query

Description	Sets or queries the I ² C bus address value when the I ² C search trigger is set to trigger on Address or Address/Data.	
Syntax	:SEARCH:TRIGger:BUS:B1:I2C:ADDRess:VALue {string ?}	
Related commands	:SEARCH:TRIGger:BUS:B1:I2C:ADDRess:MODE	
Parameter	<string>	7/10 characters, must be enclosed in double quotes "string". x = don't care 1 = binary 1 0 = binary 0
Return Parameter	Returns the address value in binary.	
Example1	:SEARCH:TRIGger:BUS:B1:I2C:ADDRess:MODE ADDR7 :SEARCH:TRIGger:BUS:B1:I2C:ADDRess:VALue "xxx0101" Sets the address to XXX0101	
Example 2	:SEARCH:TRIGger:BUS:B1:I2C:ADDRess:VALue? XXX0101	

3-20-24. :SEARCH:TRIGger:BUS:B1:I2C:ADDReSS:DIRRection

Set →

→ Query

Description	Sets or queries the address bit as read write or don't care for the search function.
Note	This setting only applies when the I ² C search trigger is set to trigger on Address or Address/Data
Syntax	:SEARCH:TRIGger:BUS:B1:I2C:ADDReSS:DIRRection { READ WRITE NOCARE ? }
Related commands	:SEARCH:TRIGger:BUS:B1:I2C:CONDition
Parameter	READ Set read as the data direction. WRITE Set write as the data direction. NOCARE Set either as the data direction.
Return Parameter	Returns the direction (READ, WRITE, NOCARE).
Example	:SEARCH:TRIGger:BUS:B1:I2C:ADDReSS:DIRRection READ Sets the direction to READ.

3-20-25. :SEARCH:TRIGger:BUS:B1:I2C:DATA:SIZE

Set →

→ Query

Description	Sets or queries the data size in bytes for the I ² C bus.
Note	This setting only applies when the I ² C search trigger is set to trigger on Data or Address/Data
Syntax	:SEARCH:TRIGger:BUS:B1:I2C:DATA:SIZE {<NR1> ? }
Related commands	:SEARCH:TRIGger:BUS:B1:I2C:CONDition
Parameter	<NR1> Number of data bytes (1 to 5).
Return parameter	<NR1> Returns the number of bytes.
Example	:SEARCH:TRIGger:BUS:B1:I2C:DATA:SIZE 3 Sets the number of bytes to 3.

3-20-26. :SEARCH:TRIGger:BUS:B1:I2C:DATa:VALue

Set →

← Query

Description	Sets or queries the triggering data value for the I ² C bus when the I ² C search trigger is set to trigger on Data or Address/Data.	
Syntax	:SEARCH:TRIGger:BUS:B1:I2C:DATa:VALue {string ? }	
Related commands	:SEARCH:TRIGger:BUS:B1:I2C:DATa:SIZE	
Parameter	<string>	The number of characters in the string depends on the data size setting. The string must be enclosed in double quotes, "string". x = don't care 1 = binary 1 0 = binary 0
Return Parameter	Returns the data value.	
Example1	:SEARCH:TRIGger:BUS:B1:I2C:DATa:SIZE 1 :SEARCH:TRIGger:BUS:B1:I2C:DATa:VALue "1x1x0101" Sets the value to XXX0101	
Example 2	:SEARCH:TRIGger:BUS:B1:I2C:DATa:VALue? 1X1X0101	

3-20-27. :SEARCH:TRIGger:BUS:B1:UART:CONDition

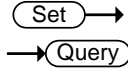

Description	Sets or queries the UART search triggering condition.	
Syntax	:SEARCH:TRIGger:BUS:B1:UART:CONDition { RXStArt RXDATA RXENDPacket TXStArt TXDATA TXENDPacket TXPARItYerr RXPARItYerr ? }	
Parameter	RXStArt	Set search trigger on the RX Start Bit.
	RXDATA	Set search trigger on RX Data.
	RXENDPacket	Set search trigger on the RX End of Packet condition.
	RXPARItYerr	Set search trigger on RX Parity error condition.
	TXStArt	Set search trigger on the TX Start Bit.
	TXDATA	Set search trigger on TX Data.
	TXENDPacket	Set search trigger on the TX End of Packet condition.
	TXPARItYerr	Set search trigger on TX Parity error condition.
Return Parameter	Returns the search triggering condition.	
Example	:SEARCH:TRIGger:BUS:B1:UART:CONDition TXDATA Sets the UART bus to trigger on Tx Data for the search function.	

3-20-28. :SEARCH:TRIGger:BUS:B1:UART:RX:DATA:SIZE

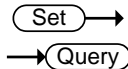

Description	Sets or queries the number of bytes for UART data.	
Note	This setting only applies when the UART search trigger is set to trigger on Rx Data	
Syntax	:SEARCH:TRIGger:BUS:B1:UART:RX:DATA:SIZE {<NR1> ?}	
Related commands	:SEARCH:TRIGger:BUS:B1:UART:CONDition	
Parameter	<NR1>	Number of bytes (1 to 10).
Return parameter	<NR1>	Returns the number of bytes.
Example	:SEARCH:TRIGger:BUS:B1:UART:RX:DATA:SIZE 5 Sets the number of bytes to 5.	

3-20-29. :SEARCH:TRIGger:BUS:B1:UART:RX:DATA:VALue

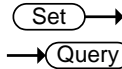

Description	Sets or queries the search triggering data value for the UART bus when the bus is set to trigger on Rx Data.	
Syntax	:SEARCH:TRIGger:BUS:B1:UART:RX:DATA:VALue {string ? }	
Related commands	:SEARCH:TRIGger:BUS:B1:UART:RX:DATA:SIZE	
Parameter	<string>	The number of characters in the string depends on the data size setting. The string must be enclosed in double quotes, "string". x = don't care 1 = binary 1 0 = binary 0
Return Parameter	Returns the data value.	
Example1	:SEARCH:TRIGger:BUS:B1:UART:CONDition RXDATA :SEARCH:TRIGger:BUS:B1:UART:RX:DATA:Size 1 :SEARCH:TRIGger:BUS:B1:UART:RX:DATA:VALue "1x1x0101" Sets the value to 1x1x0101	
Example 2	:SEARCH:TRIGger:BUS:B1:UART:RX:DATA:VALue? 1X1X0101	

3-20-30. :SEARCH:TRIGger:BUS:B1:UART:TX:DATA:SIZE

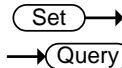

Description	Sets or queries the number of bytes for UART data.	
Note	This setting only applies when the UART search trigger is set to trigger on Tx Data	
Syntax	:SEARCH:TRIGger:BUS:B1:UART:TX:DATA:SIZE {<NR1> ? }	
Related commands	:SEARCH:TRIGger:BUS:B1:UART:CONDition	
Parameter	<NR1>	Number of bytes (1 to 10).
Return parameter	<NR1>	Returns the number of bytes.
Example	:SEARCH:TRIGger:BUS:B1:UART:TX:DATA:SIZE 5 Sets the number of bytes to 5.	

3-20-31. :SEARCH:TRIGger:BUS:B1:UART:TX:DATa:VALue

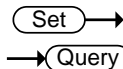

Description	Sets or queries the search triggering data value for the UART bus when the bus is set to trigger on Tx Data.	
Syntax	:SEARCH:TRIGger:BUS:B1:UART:TX:DATa:VALue {string ? }	
Related commands	:SEARCH:TRIGger:BUS:B1:UART:TX:DATa:SIZE	
Parameter	<string>	The number of characters in the string depends on the data size setting. The string must be enclosed in double quotes, "string". x = don't care 1 = binary 1 0 = binary 0
Return Parameter	Returns the data value.	
Example1	:SEARCH:TRIGger:BUS:B1:UART:CONDition TXDATA :SEARCH:TRIGger:BUS:B1:UART:TX:DATa:SIZE 1 :SEARCH:TRIGger:BUS:B1:UART:TX:DATa:VALue "1x1x0101" Sets the value to 1x1x0101	
Example 2	:SEARCH:TRIGger:BUS:B1:UART:TX:DATa:VALue? 1X1X0101	

3-20-32. :SEARCH:TRIGger:BUS:B1:SPI:CONDition

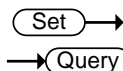

Description	Sets or queries the SPI search triggering condition.	
Syntax	:SEARCH:TRIGger:BUS:B1:SPI:CONDition {SS MISO MOSI MISOMOSI ? }	
Parameter	SS	Set to trigger on the Slave Selection condition.
	MISO	Set to trigger on the Master-In Slave-Out condition.
	MOSI	Set to trigger on the Master-Out Slave-In condition.
	MISOMOSI	Set to trigger on the Master-In Slave-Out and Master-Out Slave-In conditions.
Return Parameter	Returns the triggering condition.	
Example	:SEARCH:TRIGger:BUS:B1:SPI:CONDition MISO Sets the SPI bus to trigger on MISO.	

3-20-33. :SEARCH:TRIGger:BUS:B1:SPI:DATa:SIZE

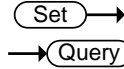

Description	Sets or queries the number of words for SPI data for the search function.
Note	This setting only applies when the SPI search trigger is set to trigger on MISO, MOSI or MISO/MOSI
Syntax	:SEARCH:TRIGger:BUS:B1:SPI:DATa:SIZE {<NR1> ?}
Related commands	:SEARCH:TRIGger:BUS:B1:SPI:CONDition
Parameter	<NR1> Number of words (1 to 32).
Return parameter	<NR1> Returns the number of words.
Example	:SEARCH:TRIGger:BUS:B1:SPI:DATa:SIZE 10 Sets the number of words to 10.

3-20-34. :SEARCH:TRIGger:BUS:B1:SPI:DATa:MISO:VALue

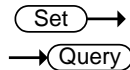

Description	Sets or queries the search triggering data value for the SPI bus when the bus is set to trigger on MISO or MISO/MOSI.
Syntax	:SEARCH:TRIGger:BUS:B1:SPI:DATa:MISO:VALue {string ?}
Related commands	:SEARCH:TRIGger:BUS:B1:SPI:DATa:SIZE
Parameter	<sting> The number of characters in the string depends on the data size setting. The string must be enclosed in double quotes, "string". x = don't care 1 = binary 1 0 = binary 0
Return Parameter	Returns the data value.
Example1	:SEARCH:TRIGger:BUS:B1:SPI:CONDition MISO :SEARCH:TRIGger:BUS:B1:SPI:DATa:SIZE 2 :SEARCH:TRIGger:BUS:B1:SPI:DATa:MISO:VALue "1x1x0101" Sets the value to 1x1x0101
Example 2	:SEARCH:TRIGger:BUS:B1:SPI:DATa:MISO:VALue? 1X1X0101

3-20-35. :SEARCH:TRIGger:BUS:B1:SPI:DATa:MOSI:VALue

Set →

→ Query

Description	Sets or queries the search triggering data value for the SPI bus when the bus is set to trigger on MOSI or MISO/MOSI.	
Syntax	:SEARCH:TRIGger:BUS:B1:SPI:DATa:MOSI:VALue {string ? }	
Related commands	:SEARCH:TRIGger:BUS:B1:SPI:DATa:SIze	
Parameter	<string>	The number of characters in the string depends on the data size setting. The string must be enclosed in double quotes, "string". x = don't care 1 = binary 1 0 = binary 0
Return Parameter	Returns the data value.	
Example1	:SEARCH:TRIGger:BUS:B1:SPI:CONDition MOSI :SEARCH:TRIGger:BUS:B1:SPI:DATa:SIze 2 :SEARCH:TRIGger:BUS:B1:SPI:DATa:MOSI:VALue "1x1x0101" Sets the value to 1x1x0101	
Example2	:SEARCH:TRIGger:BUS:B1:SPI:DATa:MOSI:VALue? 1X1X0101	

3-20-36. :SEARCH:TRIGger:BUS:B1:CAN:CONDition

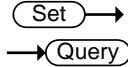

Description	Sets or returns the CAN search trigger condition.	
Syntax	:SEARCH:TRIGger:BUS:B1:CAN:CONDition {SOF FRAMeType Identifer DATA IDANDDATA EOF ACKMISS STUFFERR ?}	
Parameter/ Return parameter	SOF	Sets search to trigger on a start of frame
	FRAMeType	Sets search to trigger on the type of frame
	Identifer	Sets search to trigger on a matching identifier
	DATA	Sets search to trigger on matching data
	IDANDDATA	Sets search to trigger on matching identifier and data field
	EOF	Sets search to trigger on the end of frame
	ACKMISS	Sets search to trigger on a missing acknowledge
	STUFFERR	Sets search to trigger on a bit stuffing error
Example1	:SEARCH:TRIGger:BUS:B1:CAN:CONDition SOF Triggers search on a start of frame.	
Example2	:SEARCH:TRIGger:BUS:B1:CAN:CONDition? >SOF	

3-20-37. :SEARCH:TRIGger:BUS:B1:CAN:FRAMeType

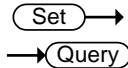

Description	Sets or returns the frame type for the CAN FRAMeType search trigger.	
Syntax	:SEARCH:TRIGger:BUS:B1:CAN:FRAMeType {DATA REMOte ERRor OVERLoad ?}	
Parameter/ Return parameter	DATA	Sets the frame type to data frame
	REMOte	Sets the frame type to remote frame
	ERRor	Sets the frame type to error frame
	OVERLoad	Sets the frame type to overload
Example	:SEARCH:TRIGger:BUS:B1:CAN:FRAMeType DATA Sets the frame type to DATA.	

3-20-38. :SEARCH:TRIGger:BUS:B1:CAN:IDentifier:MODE

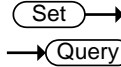

Description	Sets or returns the CAN addressing mode for the bus.	
Syntax	:SEARCH:TRIGger:BUS:B1:CAN:IDentifier:MODE {STANDARD EXTENDED ?}	
Parameter/ Return parameter	STANDARD	Standard addressing mode
	EXTENDED	Extended addressing mode
Example	:SEARCH:TRIGger:BUS:B1:CAN:IDentifier:MODE? >STANDARD :SEARCH:TRIGger:BUS:B1:CAN:IDentifier:MODE EXTENDED :SEARCH:TRIGger:BUS:B1:CAN:IDentifier:MODE? >EXTENDED	

3-20-39. :SEARCH:TRIGger:BUS:B1:CAN:IDentifier:VALue

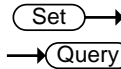

Description	Sets or returns the binary address string used for the CAN search trigger. Note: Only applicable when the search trigger condition is set to ID or IDANDDATA.	
Syntax	:SEARCH:TRIGger:BUS:B1:CAN:IDentifier:VALue {<string> ?}	
Related Commands	:SEARCH:TRIGger:BUS:B1:CAN:IDentifier:MODE	
Parameter/ Return parameter	<string>	The size of the string depends on the data size setting. The string must be enclosed in double quotes, "string". String contents: x = don't care 1 = binary 1 0 = binary 0
Example	:SEARCH:TRIGger:BUS:B1:CAN:CONDition ID :SEARCH:TRIGger:BUS:B1:CAN:IDentifier:MODE STANDARD :SEARCH:TRIGger:BUS:B1:CAN:IDentifier:VALue "01100X1X01X" :SEARCH:TRIGger:BUS:B1:CAN:IDentifier:VALue? >01100X1X01X	

3-20-40. :SEARCH:TRIGger:BUS:B1:CAN:IDentifier:DIRection

Set →

→ Query

Description	Sets or queries the address bit as read, write or don't care.	
Syntax	:SEARCH:TRIGger:BUS:B1:CAN:IDentifier:DIRection {READ WRITE NOCARE ?}	
Parameter/ Return parameter	READ	Sets read as the data direction
	WRITE	Sets write as the data direction
	NOCARE	Sets either as the data direction
Example2	:SEARCH:TRIGger:BUS:B1:CAN:IDentifier:DIRection? >WRITE :SEARCH:TRIGger:BUS:B1:CAN:IDentifier:DIRection READ :SEARCH:TRIGger:BUS:B1:CAN:IDentifier:DIRection?> READ	

3-20-41. :SEARCH:TRIGger:BUS:B1:CAN:DATA:QUALifier

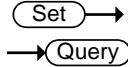

Description	Sets or returns the CAN data qualifier. Note: Only applicable when the search triggering condition is set to DATA or IDANDDATA.	
Syntax	:SEARCH:TRIGger:BUS:B1:CAN:DATA:QUALifier {LESSthan THAN Equal UNEQual LESSEQual MOREEQual ?}	
Parameter/ Return parameter	LESSthan	Sets search to trigger when the data is less than the qualifier value.
	THAN	Sets search to trigger when the data is greater than the qualifier value.
	Equal	Sets search to trigger when the data is equal to the qualifier value.
	UNEQual	Sets search to trigger when the data is not equal to the qualifier value.
	LESSEQual	Sets search to trigger when the data is less than or equal to the qualifier value.
	MOREEQual	Sets search to trigger when the data is more than or equal to the qualifier value.
Example	:SEARCH:TRIGger:BUS:B1:CAN:DATA:QUALifier?>EQUAL :SEARCH:TRIGger:BUS:B1:CAN:DATA:QUALifier THAN :SEARCH:TRIGger:BUS:B1:CAN:DATA:QUALifier?>THAN	

3-20-42. :SEARCH:TRIGger:BUS:B1:CAN:DATA:SIZE

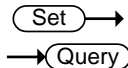

Description	Sets or returns the length of the data string in bytes for the CAN search trigger. Note: Only applicable when the condition is set to DATA or IDANDDATA.	
Syntax	:SEARCH:TRIGger:BUS:B1:CAN:DATA:SIZE {<NR1> ?}	
Parameter/ Return parameter	<NR1>	1-8 (bytes)
Example	:SEARCH:TRIGger:BUS:B1:CAN:DATA:SIZE?>1 :SEARCH:TRIGger:BUS:B1:CAN:DATA:SIZE 2 :SEARCH:TRIGger:BUS:B1:CAN:DATA:SIZE?>2	

3-20-43. :SEARCH:TRIGger:BUS:B1:CAN:DATA:VALue

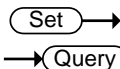

Description	Sets or returns the binary data string to be used for the CAN search trigger. Note: Only applicable when the condition is set to DATA or IDANDDATA.	
Related Commands	:SEARCH:TRIGger:BUS:B1:CAN:DATA:SIZE	
Syntax	:SEARCH:TRIGger:BUS:B1:CAN:DATA:VALue {<string> ?}	
Parameter/ Return parameter	<string>	The size of the string depends on the data size setting. The string must be enclosed in double quotes, "string". String contents: x = don't care 1 = binary 1 0 = binary 0
Example	:SEARCH:TRIGger:BUS:B1:CAN:DATA:SIZE 1 :SEARCH:TRIGger:BUS:B1:CAN:DATA:VALue "01010X1X" :SEARCH:TRIGger:BUS:B1:CAN:DATA:VALue? >01010X1X	

3-20-44. :SEARCH:TRIGger:BUS:B1:LIN:CONDition

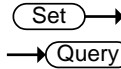

Description	Sets or returns the LIN search trigger condition.	
Syntax	:SEARCH:TRIGger:BUS:B1:LIN:CONDition {SYNCFIELD IDENTIFIER DATA IDANDDATA WAKEUP SLEEP ERROR ?}	
Parameter/ Return parameter	SYNCFIELD	Sets the LIN search trigger condition to the sync field.
	IDENTIFIER	Sets the LIN search trigger condition to identifier field.
	DATA	Sets the LIN search trigger condition to the data field.
	IDANDDATA	Sets the LIN search trigger condition to identifier and data field
	WAKEUP	Sets the LIN search trigger condition to wake up.
	SLEEP	Sets the LIN search trigger condition to sleep.
	ERROR	Sets the LIN search trigger condition to error.
Example	:SEARCH:TRIGger:BUS:B1:LIN:CONDition? >IDANDDATA :SEARCH:TRIGger:BUS:B1:LIN:CONDition DATA :SEARCH:TRIGger:BUS:B1:LIN:CONDition? >DATA	

3-20-45. :SEARCH:TRIGger:BUS:B1:LIN:DATa:QUALifier

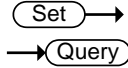

Description	Sets or returns the LIN data qualifier. Note: Only applicable when the search trigger condition is set to DATA or IDANDDATA.	
Syntax	:SEARCH:TRIGger:BUS:B1:LIN:DATa:QUALifier {LESSthan THAN EQual UNEQual LESSEQual MOREEQual ?}	
Parameter/ Return parameter	LESSthan	Sets search to trigger when the data is less than the qualifier value.
	THAN	Sets search to trigger when the data is greater than the qualifier value.
	EQual	Sets search to trigger when the data is equal to the qualifier value.
	UNEQual	Sets search to trigger when the data is not equal to the qualifier value.
	LESSEQual	Sets search to trigger when the data is less than or equal to the qualifier value.
	MOREEQual	Sets search to trigger when the data is more than or equal to the qualifier value.
	LESSthan	Sets search to trigger when the data is less than the qualifier value.
Example	:SEARCH:TRIGger:BUS:B1:LIN:DATa:QUALifier? >EQUAL :SEARCH:TRIGger:BUS:B1:LIN:DATa:QUALifier THAN :SEARCH:TRIGger:BUS:B1:LIN:DATa:QUALifier? >THAN	

3-20-46. :SEARCH:TRIGger:BUS:B1:LIN:DATa:SIZE

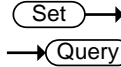

Description	Sets or returns the length of the data string in bytes for the LIN search trigger. Note: Only applicable when the condition is set to DATA or IDANDDATA.	
Syntax	:SEARCH:TRIGger:BUS:B1:LIN:DATa:SIZE {<NR1> ?}	
Parameter/ Return parameter	<NR1>	1-8 (bytes)
Example	:SEARCH:TRIGger:BUS:B1:LIN:DATa:SIZE? >1 :SEARCH:TRIGger:BUS:B1:LIN:DATa:SIZE 2 :SEARCH:TRIGger:BUS:B1:LIN:DATa:SIZE? >2	

3-20-47. :SEARCH:TRIGger:BUS:B1:LIN:DATa:VALue

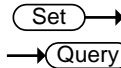

Description	Sets or returns the binary data string to be used for the LIN search trigger. Note: Only applicable when the condition is set to DATA or IDANDDATA.	
Related Commands	:SEARCH:TRIGger:BUS:B1:LIN:DATa:SIZE	
Syntax	:SEARCH:TRIGger:BUS:B1:LIN:DATa:VALue {<string> ?}	
Parameter/ Return parameter	<string>	The size of the string depends on the data size setting. The string must be enclosed in double quotes, "string". String contents: x = don't care 1 = binary 1 0 = binary 0
Example	:SEARCH:TRIGger:BUS:B1:LIN:DATa:SIZE 1 :SEARCH:TRIGger:BUS:B1:LIN:DATa:VALue "01010X1X" :SEARCH:TRIGger:BUS:B1:LIN:DATa:VALue? >01010X1X	

3-20-48. :SEARCH:TRIGger:BUS:B1:LIN:ERRTYPE

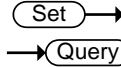

Description	Sets or returns the error type be used for the LIN search trigger.	
Syntax	:SEARCH:TRIGger:BUS:B1:LIN:ERRTYPE {SYNC PARItY ChEcksum ?}	
Parameter/ Return parameter	SYNC	Sets the LIN error type to SYNC.
	PARItY	Sets the LIN error type to parity.
	ChEcksum	Sets the LIN error type to checksum.
Example	:SEARCH:TRIGger:BUS:B1:LIN:ERRTYPE? >SYNC :SEARCH:TRIGger:BUS:B1:LIN:ERRTYPE CHECKSUM :SEARCH:TRIGger:BUS:B1:LIN:ERRTYPE? >CHECKSUM	

3-20-49. :SEARCH:TRIGger:BUS:B1:LIN:IDentifier:VALue

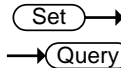

Description	Sets or returns the binary address string to be used for the LIN search trigger. Note: Only applicable when the condition is set to DATA or IDANDDATA.	
Syntax	:SEARCH:TRIGger:BUS:B1:LIN:IDentifier:VALue {<string> ?}	
Parameter/ Return parameter	<string>	The size of the string depends on the data size setting. The string must be enclosed in double quotes, "string". String contents: x = don't care 1 = binary 1 0 = binary 0
Example	:SEARCH:TRIGger:BUS:B1:LIN:CONDition ID :SEARCH:TRIGger:BUS:B1:LIN:IDentifier:VALue "00X1X01X" :SEARCH:TRIGger:BUS:B1:LIN:IDentifier:VALue? >01100X1X01X	

3-20-50. :SEARCH:FFTPeak:METHOD

Set →

→ Query

Description	Sets or returns the FFT peak method type.	
Related	:SEARCH:TRIGger:TYPe	
Commands	:SEARCH:FFTPeak:METHOD:MPEak :SEARCH:TRIGger:LEVel	
Syntax	:SEARCH:FFTPeak:METHOD {MPEak LEVel ?}	
Parameter/ Return parameter	MPEak	Sets the peak method to the Max Peak type.
	LEVel	Sets the peak methods to the Level type.
Example	:SEARCH:FFTPeak:METHOD LEVel :SEARCH:FFTPeak:METHOD? >LEVEL :SEARCH:TRIGger:LEVel? >1.000E+00 :SEARCH:TRIGger:LEVel 2 :SEARCH:TRIGger:LEVel? >2.000E+00	

3-20-51. :SEARCH:FFTPeak:METHOD:MPEak

Set →

→ Query

Description	Sets the active peak number (1 ~ 10) or return the frequency of the active peak number.	
Related	:SEARCH:TRIGger:TYPe	
Commands	:SEARCH:FFTPeak:METHOD	
Syntax	:SEARCH:FFTPeak:METHOD:MPEak {<NR1> ?}	
Parameter	<NR1>	Active peak number.
Return parameter	<NR3>	Frequency of the active peak.
Example	:SEARCH:FFTPeak:METHOD MPEak :SEARCH:FFTPeak:METHOD? >MPEAK :SEARCH:FFTPeak:METHOD:MPEak? >1.000E+00 :SEARCH:FFTPeak:METHOD:MPEak 2 :SEARCH:FFTPeak:METHOD:MPEak? >2.000E+00	

3-20-52. :SEARCH:FFTPeak:SINFo

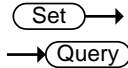

Description	Sets or returns the State Info to "Mark" or "Peak".	
Related	:SEARCH:TRIGger:TYPe	
Commands		
Syntax	:SEARCH:FFTPeak:SINFo {MARK PEAK ?}	
Parameter/ Return parameter	MARK	Sets the State Info to Mark.
	PEAK	Sets the State Info to Peak.
Example	:SEARCH:FFTPeak:SINFo? >PEAK :SEARCH:FFTPeak:SINFo mark :SEARCH:FFTPeak:SINFo? >MARK	

3-21. Label Commands

3-21-1. :CHANnel<X>:LABel	156
3-21-2. :CHANnel<X>:LABel:DISPlay	157
3-21-3. :REF<X>:LABel.....	157
3-21-4. :REF<X>:LABel:DISPlay	158
3-21-5. :BUS1:LABel.....	158
3-21-6. :BUS1:LABel:DISPlay	159
3-21-7. :SET<X>:LABel.....	159

3-21-1. :CHANnel<X>:LABel

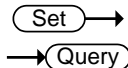

Description	Sets or returns the file label for the selected channel.	
Syntax	:CHANnel<X>:LABel {<string> ?}	
Related commands	:CHANnel<X>:LABel:DISPlay	
Parameter	<X>	Channel 1, ,2, 3, 4
	<string>	The string must be no more than 8 characters and only contain alphanumeric characters in addition to period, dash and underscore characters. The string must be enclosed in double quotes, "string".
Return parameter	<string>	Returns the label for the selected channel. No return indicates that there has not been a file label assigned for the selected channel.
Example1	:CHANnel1:LABel "CH1_lab" Sets the channel 1 label as "CH1_lab".	
Example2	:CHANnel1:LABel? CH1_lab	

3-21-2. :CHANnel<X>:LABel:DISPlay

Set →

→ Query

Description	Turns the label on/off for the selected channel or returns its status.
Syntax	:CHANnel<X>:LABel:DISPlay { OFF ON ? }
Related commands	:CHANnel<X>:LABel
Parameter	<X> Channel 1, 2, 3, 4 OFF Turns the file label off for the selected channel. ON Turns the file label on for the selected channel.
Return parameter	Returns the status of the file label for the selected channel (ON, OFF).
Example	:CHANnel1:LABel "CH1" :CHANnel1:LABel:DISPlay ON :CHANnel1:LABel:DISPlay? ON Sets the channel 1 label to "CH1" and then turns the label display on. The query return shows that the label is on.

3-21-3. :REF<X>:LABel

Set →

→ Query

Description	Sets or returns the file label for the selected reference waveform.
Syntax	:REF<X>:LABel {<string> ?}
Related commands	:REF<X>:LABel:DISPlay
Parameter	<X> REF 1, 2, 3, 4 <string> The string must be no more than 8 characters and only contain alphanumeric characters in addition to period, dash and underscore characters. The string must be enclosed in double quotes, "string".
Return parameter	<string> Returns the label for the selected reference waveform. No return indicates that there has not been a file label assigned for the selected reference waveform.
Example1	:REF1:LABel "REF1_lab" Sets the REF1 label as "REF1_lab".
Example2	:REF1:LABel? REF1_lab

3-21-4. :REF<X>:LABel:DISPlay

Set →

→ Query

Description	Turns the label on/off for the selected reference waveform or returns its status.	
Syntax	:REF<X>:LABel:DISPlay { OFF ON ? }	
Related commands	:REF<X>:LABel	
Parameter	<X> OFF ON	Reference waveform 1, 2, 3, 4 Turns the file label off for the selected reference waveform. Turns the file label on for the selected reference waveform.
Return parameter	Returns the status of the file label for the selected reference waveform (ON, OFF).	
Example	:REF1:LABel "REF1" :REF1:LABel:DISPlay ON :REF1:LABel:DISPlay? ON Sets the label for reference waveform 1 to "REF1" and then turns the label display on. The query return shows that the label is on.	

3-21-5. :BUS1:LABel

Set →

→ Query

Description	Sets or returns the file label for the bus.	
Syntax	:BUS1:LABel {<string> ?}	
Related commands	:BUS1:LABel:DISPlay	
Parameter	<string>	The string must be no more than 8 characters and only contain alphanumeric characters in addition to period, dash and underscore characters. The string must be enclosed in double quotes, "string".
Return parameter	<string>	Returns the label for the bus. No return indicates that there has not been a file label assigned for bus.
Example1	:BUS1:LABel "Bus" Sets the bus label as "Bus".	
Example2	:BUS1:LABel? Bus	

3-21-6. :BUS1:LABel:DISPlay

Set →

→ Query

Description	Turns the label on/off for the bus or returns its status.	
Syntax	:BUS1:LABel:DISPlay { OFF ON ? }	
Related commands	:BUS1:LABel	
Parameter	OFF	Turns the file label off for the bus.
	ON	Turns the file label on for the bus.
Return parameter	Returns the status of the file label for the bus (ON, OFF).	
Example	<pre>:BUS1:LABel "Bus" :BUS1:LABel:DISPlay ON :BUS1:LABel:DISPlay? ON Sets the label for the bus to "Bus" and then turns the label display on. The query return shows that the label is on.</pre>	

3-21-7. :SET<X>:LABel

Set →

→ Query

Description	Sets or returns the file label for the selected setup.	
Syntax	:SET<X>:LABel {<string> ?}	
Related commands	:SET<X>:LABel:DISPlay	
Parameter	<X>	Setup number 1 to 20
	<string>	The string must be no more than 8 characters and only contain alphanumeric characters in addition to period, dash and underscore characters. The string must be enclosed in double quotes, "string".
Return parameter	<string>	Returns the label for the selected setup. No return indicates that there has not been a file label assigned for the selected setup.
Example1	<pre>:SET1:LABel "SET1_lab" Sets the label for setup 1 as "SET1_lab".</pre>	
Example2	<pre>:SET1:LABel? SET1_lab</pre>	

3-22. Segment Commands

3-22-1. :SEGMENTS:STATE	160
3-22-2. :SEGMENTS:CURRENT	161
3-22-3. :SEGMENTS:TOTALNUM	161
3-22-4. :SEGMENTS:TIME	161
3-22-5. :SEGMENTS:DISPALL	162
3-22-6. :SEGMENTS:MEASURE:MODE	162
3-22-7. :SEGMENTS:MEASURE:PLOT:SOURCE	162
3-22-8. :SEGMENTS:MEASURE:PLOT:DIVIDE	163
3-22-9. :SEGMENTS:MEASURE:PLOT:SELECT	163
3-22-10. :SEGMENTS:MEASURE:PLOT:RESULTS	163
3-22-11. :SEGMENTS:MEASURE:TABLE:SOURCE	164
3-22-12. :SEGMENTS:MEASURE:TABLE:SELECT	164
3-22-13. :SEGMENTS:MEASURE:TABLE:LIST	164
3-22-14. :SEGMENTS:MEASURE:TABLE:SAVE	165
3-22-15. :SEGMENTS:SAVE	165
3-22-16. :SEGMENTS:SAVE:SOURCE	165
3-22-17. :SEGMENTS:SAVE:SELECT:START	165
3-22-18. :SEGMENTS:SAVE:SELECT:END	166

3-22-1. :SEGMENTS:STATE

Set →

→ Query

Description	Turns the segmented memory function on/off or queries its state.	
Syntax	:SEGMENTS:STATE { OFF ON ? }	
Related commands	:RUN ; :STOP	
Parameter/	OFF	Turns the segmented memory off.
Return parameter	ON	Turns the segmented memory on.
Example1	:SEGMENTS:STATE ON Turns segmented memory on.	

3-22-2. :SEGMents:CURRent

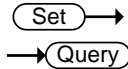

Description	Sets or queries the current segment.	
Syntax	:SEGMents:CURRent {SETTOMIN SETTOMAX NR1 ?}	
Related commands	:SEGMents:STATE ; :SEGMents:TOTAlnum	
Parameter/ Return parameter	SETTOMIN SETTOMA X <NR1>	Current segment = min segment Current segment = max segment 1~2048
Example1	:SEGMents:CURRent 10 Sets the current segment to segment number 10.	

3-22-3. :SEGMents:TOTAlnum

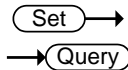

Description	Sets or queries the total number of segments for the segmented memory function.	
Syntax	:SEGMents:TOTAlnum {SETTOMIN SETTOMAX <NR1> ?}	
Related commands	:SEGMents:STATE ; :SEGMents:CURRent	
Parameter/ Return parameter	SETTOMIN SETTOMA X <NR1>	Sets to the minimum number Sets to the maximum number 1~2048
Example1	:SEGMents:TOTAlnum SETTOMAX Sets the number of segments to max number (2048).	

3-22-4. :SEGMents:TIMe



Description	Returns the time of the current segment in relation to the first segment.	
Syntax	:SEGMents:TIMe?	
Related commands	:SEGMents:STATE ; :SEGMents:CURRent	
Return parameter	The segment time as <NR3>.	
Example	:SEGMents:TIMe? >8.040E-03 Returns the segment time.	

3-22-5. :SEGMents:DISPALL

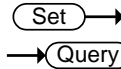

Description	Sets or queries whether all the segments are displayed on the screen.	
Syntax	:SEGMents:DISPALL {OFF ON ?}	
Related commands	:SEGMents:STATE ; :SEGMents:CURRent	
Parameter/ Return parameter	OFF	Turns the display all function off.
	ON	Turns the display all function on.
Example1	:SEGMents:DISPALL ON Turns the display all function on.	

3-22-6. :SEGMents:MEASure:MODE

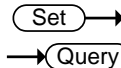

Description	Sets or queries the measurement mode.	
Syntax	:SEGMents:MEASure:MODE {OFF PLOT TABLE ?}	
Related commands	:MEASurement:MEAS<x>	
Parameter/ Return parameter	OFF	Disables the automatic measurement function for the segments measurement.
	PLOT	Sets the measurement mode to Statistics.
	TABLE	Sets the measurement mode to a measurement list.
Example1	:SEGMents:MEASure:MODE? >PLOT Returns the measurement mode as Statistics.	

3-22-7. :SEGMents:MEASure:PLOT:SOURce

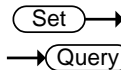

Description	Sets or queries the statistics source.	
Syntax	:SEGMents:MEASure:PLOT:SOURce {<NR1> ? }	
Related commands	:SEGMents:MEASure:MODE ; :SEGMents:MEASure:PLOT:DIVide ; :SEGMents:MEASure:PLOT:SELect ; :SEGMents:MEASure:PLOT:RESults	
Parameter/ Return parameter	<NR1>	1~8 (automatic measurement item)
Example1	:SEGMents:MEASure:PLOT:SOURce 1 Sets the source as first automatic measurement.	

3-22-8. :SEGMents:MEASure:PLOT:DIVide

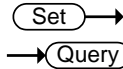

Description	Sets or queries the number of bins for the statistics function.
Syntax	:SEGMents:MEASure:PLOT:DIVide {<NR1> ? }
Related commands	:SEGMents:MEASure:PLOT:SOURce ; :SEGMents:MEASure:PLOT:SElect
Parameter/ Return parameter	<NR1> 1~20
Example1	:SEGMents:MEASure:PLOT:DIVide 5 Sets the number bins to 5 for the statistics function.

3-22-9. :SEGMents:MEASure:PLOT:SElect

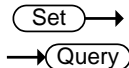

Description	Sets or queries which bin to view the statics of.
Syntax	:SEGMents:MEASure:PLOT:SElect {<NR1> ? }
Related commands	:SEGMents:MEASure:PLOT:SOURce ; :SEGMents:MEASure:PLOT:DIVide
Parameter	<NR1> 1~20 (cannot exceed the number of bins)
Return parameter	Return the bin number as <NR3>.
Example1	:SEGMents:MEASure:PLOT:SElect 5 Set to bin number 5.

3-22-10. :SEGMents:MEASure:PLOT:RESults

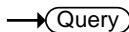

Description	Returns the results of the currently selected bin for the statistics measurement.
Syntax	:SEGMents:MEASure:PLOT:RESults?
Related commands	:SEGMents:MEASure:PLOT:SOURce ; :SEGMents:MEASure:PLOT:DIVide ; :SEGMents:MEASure:PLOT:SElect
Return parameter	Returns the statistics measurements as a string.
Example	:SEGMents:MEASure:PLOT:RESults? > MAX:240mv,MIN:200mv,MEAN:206mv,Bin Statistics:15 of 20,Percent:0.00%,Count:0,Measured:345,Unmeasured:0,Bin Range:228~230mv

3-22-11. :SEGMents:MEASure:TABLE:SOURce

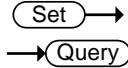

Description	Sets or queries the source of the measurement list.
Syntax	:SEGMents:MEASure:TABLE:SOURce {CH1 CH2 CH3 CH4 ? }
Related commands	:SEGMents:MEASure:MODE ; :SEGMents:MEASure:TABLE:SElect ; :SEGMents:MEASure:TABLE:LIST
Parameter/ Return parameter	CH1~CH4 Channel 1 to 4
Example1	:SEGMents:MEASure:TABLE:SOURce CH1 Sets the source to CH1.

3-22-12. :SEGMents:MEASure:TABLE:SElect

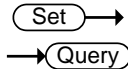

Description	Sets or queries a segment to view in the measurement table.
Syntax	:SEGMents:MEASure:TABLE:SElect {<NR1> ? }
Related commands	:SEGMents:TOTalnum
Parameter	<NR1> 1~2048
Return parameter	Returns the number of segments as <NR3>.
Example1	:SEGMents:MEASure:TABLE:SElect 10 Select segment number 10.

3-22-13. :SEGMents:MEASure:TABLE:LIST



Description	Returns the measurement results of each segment in the list.
Syntax	:SEGMents:MEASure:TABLE:LIST?
Return parameter	Returns the measurements results as a string for each segment.
Example	:SEGMents:MEASure:TABLE:LIST? >"TEXIO DCS-1000B, serial number P930116, version V1.11",Segment Summary : CH1, Seg.,Pk-Pk (V),Pk-Pk (V),1,8.00m,8.00m.....etc

3-22-14. :SEGMents:MEASure:TABLE:SAVe

→ Set →

Description	Saves the list of segment automatic measurement results.
Syntax	:SEGMents:MEASure:TABLE:SAVe

3-22-15. :SEGMents:SAVe

→ Set →

Description	Saves the segments.
Syntax	:SEGMents:SAVe
Related Commands	:SEGMents:SAVe:SOURce ; :SEGMents:SAVe:SElect:STARt ; :SEGMents:SAVe:SElect:END
Example	:SEGMents:SAVe:SOURce CH1 :SEGMents:SAVe:SElect:STARt 1 :SEGMents:SAVe:SElect:END 10 :SEGMents:SAVe

3-22-16. :SEGMents:SAVe:SOURce

→ Query

Description	Sets or queries the source segment waveform to save.
Syntax	:SEGMents:SAVe:SOURce {CH1 CH2 CH3 CH4 ? }
Parameter/Return parameter	CH1~CH4 Channel 1 to 4.
Example	:SEGMents:SAVe:SOURce CH1 >Sets the source to CH1.

3-22-17. :SEGMents:SAVe:SElect:STARt

→ Set →

→ Query

Description	Sets or queries the starting segment to save from.
Syntax	:SEGMents:SAVe:SElect:STARt {SETTOMIN SETTOMAX <NR1> ? }
Related commands	:SEGMents:TOTalnum
Parameter/Return parameter	SETTOMIN Sets the starting segment to min segment. SETTO Sets the starting segment to the max segment. MAX <NR1> Sets the segment to 1~2048.
Example	:SEGMents:SAVe:SElect:STARt 2 Sets the starting segment to segment number 2.

3-22-18. :SEGMENTS:SAVE:SELECT:END

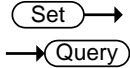

Description	Sets or queries the ending segment to save from.	
Syntax	:SEGMENTS:SAVE:SELECT:END {SETTOMIN SETTOMAX <NR1> ? }	
Related commands	:SEGMENTS:TOTALNUM	
Parameter/ Return parameter	SETTOMIN	Sets the starting segment to min segment.
	SETTOMAX	Sets the starting segment to the max segment.
	<NR1>	Sets the segment to 1~2048.
Example	:SEGMENTS:SAVE:SELECT:END 10 Sets the ending segment to segment number 10.	

3-23. DVM Commands

3-23-1. :DVM:STATE	166
3-23-2. :DVM:SOURCE	166
3-23-3. :DVM:MODE	167
3-23-4. :DVM:VALUE	167

3-23-1. :DVM:STATE

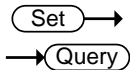

Description	Sets or queries the DVM state to on or off.	
Syntax	:DVM:STATE {OFF ON ? }	
Related commands	:DVM:SOURCE ; :DVM:MODE	
Parameter/ Return parameter	OFF	Turns the DVM off.
	ON	Turns the DVM on.
Example	:DVM:STATE ON Turns the DVM state on.	

3-23-2. :DVM:SOURCE

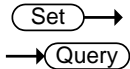

Description	Sets or queries the source of the DVM.	
Syntax	:DVM:SOURCE {CH1 CH2 CH3 CH4 ?}	
Related commands	:DVM:SOURCE ; :DVM:MODE	
Parameter/ Return parameter	CH1~CH4	Channel 1 to 4.
Example	:DVM:SOURCE CH1 Sets the DVM source to channel 1.	

3-23-3. :DVM:MODE

Set →

→ Query

Description	Sets or queries the DVM mode.	
Syntax	:DVM:MODE {ACRMS DC DCRMS DUTY FREQUENCY ?}	
Related commands	:DVM:SOURce ; :DVM:STATE	
Parameter/ Return parameter	ACRMS	Sets the mode of the DVM to AC RMS
	DC	Sets the mode of the DVM to DC
	DCRMS	Sets the mode of the DVM to DC RMS
	DUTY	Sets the mode of the DVM to AC Duty
	FREQUENCY	Sets the mode of the DVM to AC frequency
Example	:DVM:MODE DUTY Sets the DVM mode to DUTY.	

3-23-4. :DVM:VALue

→ Query

Description	Returns the measurement value of the selected mode.	
Syntax	:DVM:VALue?	
Related commands	:DVM:SOURce ; :DVM:STATE, :DVM:MODE	
Return parameter	<NR3>	Returns the measurement value as <NR3>.
Example	:DVM:VALue? >8.410E-04	

3-24. Go_NoGo Commands

The GoNoGo APP must first be launched (or use the command, “:GONogo:SCRipt”) before any of the Go_NoGo or Template commands can be used.

3-24-1. :GONogo:CLEar.....	168
3-24-2. :GONogo:EXECute.....	168
3-24-3. :GONogo:FUNCTion.....	168
3-24-4. :GONogo:NGCount.....	169
3-24-5. :GONogo:NGDefine.....	169
3-24-6. :GONogo:SOURce.....	169
3-24-7. :GONogo:VIOLation.....	170
3-24-8. :GONogo:SCRipt.....	170
3-24-9. :TEMPlate:MODE.....	170
3-24-10. :TEMPlate:MAXimum.....	171
3-24-11. :TEMPlate:MINimum.....	171
3-24-12. :TEMPlate:POSition:MAXimum.....	171
3-24-13. :TEMPlate:POSition:MINimum.....	172
3-24-14. :TEMPlate:SAVE:MAXimum.....	172
3-24-15. :TEMPlate:SAVE:MINimum.....	172
3-24-16. :TEMPlate:TOLerance.....	172
3-24-17. :TEMPlate:SAVE:AUTO.....	172

3-24-1. :GONogo:CLEar

Set →

Description	Clears the Go/NoGo counter.
Syntax	:GONogo:CLEar

3-24-2. :GONogo:EXECute

Set →

→ Query

Description	Enables or disables the Go/NoGo function or queries its state.
Syntax	:GONogo:EXECute {OFF ON ?}
Parameter/	OFF Disabled
Return Parameter	ON Enabled
Example	:GONogo:EXECute OFF Turns Go/NoGo off.

3-24-3. :GONogo:FUNCTion

Set →

Description	Initializes the Go/NoGo APP. This must be run after the Go/NoGo APP has been started.
Syntax	:GONogo:FUNCTion

3-24-4. :GONogo:NGCount

→ Query

Description	Returns the Go/NoGo counter.
Syntax	:GONogo:NGCount {?}
Return parameter	Returns a string in the following format “number of violations,total tests”
Example	:GONogo:NGCount? > 3,25 Indicates that 3 violations occurred over 25 tests.

3-24-5. :GONogo:NGDefine

Set →

→ Query

Description	Sets the Go/NoGo “When” conditions.				
Syntax	:GONogo:NGDefine {EXITs ENTers ?}				
Parameter/ Return Parameter	<table border="0"> <tr> <td>EXITs</td> <td>Sets the NoGo condition to when the input signal exceeds the limit boundary.</td> </tr> <tr> <td>ENTers</td> <td>Sets the NoGo condition to when the input signal stays within the limit boundary.</td> </tr> </table>	EXITs	Sets the NoGo condition to when the input signal exceeds the limit boundary.	ENTers	Sets the NoGo condition to when the input signal stays within the limit boundary.
EXITs	Sets the NoGo condition to when the input signal exceeds the limit boundary.				
ENTers	Sets the NoGo condition to when the input signal stays within the limit boundary.				
Example	:GONogo:NGDefine EXITs Sets the Go/NoGo condition to EXITs.				

3-24-6. :GONogo:SOURce

Set →

→ Query

Description	Sets the source for the Go/NoGo signal.
Syntax	:GONogo:SOURce {CH1 CH2 CH3 CH4 ?}
Parameter/ Return Parameter	CH1~CH4
Example	:GONogo:SOURce CH1 Sets the source to CH1.

3-24-7. :GONogo:VIOLation

Set →

→ Query

Description	Sets or returns actions for the Go/NoGo violations.	
Syntax	:GONogo:VIOLation {STOP STOP_Beep CONTInue CONTINUE_Beep ?}	
Parameter/ Return Parameter	STOP	The waveform will be frozen.
	STOP_Beep	The waveform will be frozen and a beep will be output.
	CONTInue	Ignore the violation.
	CONTINUE_Beep	Output a beep, but continue to monitor the signal.
Example	:GONogo:VIOLation STOP Sets violation action to STOP.	

3-24-8. :GONogo:SCRipt

Set →

Description	Activates/Deactivates the Go/NoGo APP or queries its state.	
Syntax	:GONogo:SCRipt {OFF ON ?}	
Parameter/ Return Parameter	ON	Turns Go/NoGo APP on.
	OFF	Turns the Go/NoGo APP off.
Example	:GONogo:SCRipt? >ON The Go/NoGo script is on.	

3-24-9. :TEMPlate:MODE

Set →

→ Query

Description	Sets or returns the Go/NoGo template mode.	
Syntax	:TEMPlate:MODE{MAXimum MINimum AUTO ?}	
Parameter/ Return Parameter	MAXimum	Maximum template
	MINimum	Minimum template
	AUTO	Auto template
Example	:TEMPlate:MODE AUTO Sets the template mode to AUTO.	

3-24-10. :TEMPLate:MAXimum

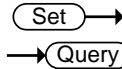

Description	Defines or queries which waveform memory (REF1 or W1~W20) is set to the maximum template.	
Syntax	:TEMPLate:MAXimum{REF1 W1~W20 ?}	
Parameter/	REF1	Reference one
Return Parameter	W1~W20	Waveform memory 1 to 20
Example	:TEMPLate:MAXimum REF1 Saves the maximum template to REF1.	

3-24-11. :TEMPLate:MINimum

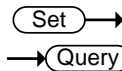

Description	Defines or queries which waveform memory (REF1 or W1~W20) is set to the minimum template.	
Syntax	:TEMPLate:MINimum{REF2 W1~W20 ?}	
Parameter/	REF2	Reference one
Return Parameter	W1~W20	Waveform memory 1 to 20
Example	:TEMPLate:MINimum REF2 Saves the minimum template to REF2.	

3-24-12. :TEMPLate:POSition:MAXimum

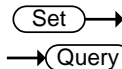

Description	Sets or queries the position of the maximum template.	
Syntax	:TEMPLate:POSition:MAXimum{NR2 ?}	
Parameter	<NR2>	Desired template position (-12.0 ~ +12.0 divisions)
Return parameter	Returns the position in the following format: "<NR2>Div"	
Example	:TEMPLate:POSition:MAXimum 3.00 Sets the maximum template position to 3.00 divisions.	

3-24-13. :TEMPLate:POSition:MINimum

Set →

→ Query

Description	Sets or queries the position of the minimum template.	
Syntax	:TEMPLate:POSition:MAXimum{NR2 ?}	
Parameter	<NR2>	Desired template position (-12.0 ~ +12.0 divisions)
Return parameter	Returns the position in the following format: "<NR2>Div"	
Example	:TEMPLate:POSition:MINimum 3.00 Sets the minimum template position to 3.00 divisions.	

3-24-14. :TEMPLate:SAVe:MAXimum

Set →

Description	Saves the maximum template.	
Syntax	:TEMPLate:SAVe:MAXimum	

3-24-15. :TEMPLate:SAVe:MINimum

Set →

Description	Saves the minimum template.	
Syntax	:TEMPLate:SAVe:MINimum	

3-24-16. :TEMPLate:TOLerance

Set →

→ Query

Description	Sets or queries the tolerance as a percentage.	
Syntax	:TEMPLate:TOLerance{NR2 ?}	
Parameter/ Return Parameter	<NR2>	The auto tolerance range (0.4% ~ 40%)
Example	:TEMPLate:TOLerance 10 Sets the tolerance to 10%.	

3-24-17. :TEMPLate:SAVe:AUTO

Set →

Description	Saves the AUTO template (maximum and minimum templates).	
Syntax	:TEMPLate:SAVe:AUTO	

3-25. Data Logging Commands

3-25-1. :DATALOG:STATE	173
3-25-2. :DATALOG:SOURce.....	173
3-25-3. :DATALOG:SAVe.....	174
3-25-4. :DATALOG:INTerval	174
3-25-5. :DATALOG:DURation	174

3-25-1. :DATALOG:STATE

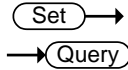

Description	Sets or queries the state of the data logging app.	
Syntax	:DATALOG:STATE{OFF ON ?}	
Related commands	:DATALOG:SOURce :DATALOG:SAVe :DATALOG:INTerval :DATALOG:DURation	
Parameter/	OFF	Turns the data logging off.
Return parameter	ON	Turns the data logging on.
Example	DATALOG:STATE ON Turns the data logging app on.	

3-25-2. :DATALOG:SOURce

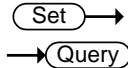

Description	Sets or queries the data logging source channel.	
Syntax	:DATALOG:SOURce {CH1~CH4 all ?}	
Related commands	:DATALOG:STATE :DATALOG:SAVe :DATALOG:INTerval :DATALOG:DURation	
Parameter/	CH1~CH4	Channel 1 to 4.
Return parameter	all	All displayed channels.
Example	:DATALOG:SOURce CH1 Sets the source to CH1.	

3-25-3. :DATALOG:SAVe

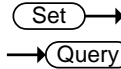

Description	Sets or queries the save format as image or waveform.	
Syntax	:DATALOG:SAVe {IMAGE WAVEform}[?]	
Related commands	:DATALOG:STATE :DATALOG:SOURce :DATALOG:INTERval :DATALOG:DURation	
Parameter/ Return parameter	IMAGE	Save as images.
	WAVEform	Save as waveforms.
Example	:DATALOG:SAVe WAVEform Sets the save format to waveform.	

3-25-4. :DATALOG:INTERval

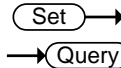

Description	Sets or queries the recording interval time in seconds.	
Syntax	:DATALOG:INTERval {<NR1>[?]}	
Related commands	:DATALOG:STATE :DATALOG:SOURce :DATALOG:SAVe :DATALOG:DURation	
Parameter/ Return parameter	<NR1>	Sets returns the interval time in discrete seconds: 2, 3, 4, 5, 10, 20, 30, 60, 120, 300, 600, 1200
Example	:DATALOG:INTERval 2 Sets the recording interval to 2 seconds.	

3-25-5. :DATALOG:DURation

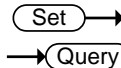

Description	Sets or queries the recording duration time in minutes.	
Syntax	:DATALOG:DURation {<NR1>[?]}	
Related commands	:DATALOG:STATE :DATALOG:SOURce :DATALOG:SAVe :DATALOG:INTERval	
Parameter/ Return parameter	<NR1>	Sets returns the duration time in discrete minutes: 5, 10, 15, 20, 25, 30, 60, 90, 120, 150, 180, 210, 240, 270, 300, 330, 360, 390, 420, 450, 480, 510, 540, 570, 600, 1200, 1800, 2400, 3000, 3600, 4200, 4800, 5400, 6000
Example	:DATALOG:DURation 10 Sets the recording duration to 10 minutes.	

3-26. Remote DiskCommands

3-26-1. :REMOTEDisk:IPADDRESS	175
3-26-2. :REMOTEDisk:PATHName	175
3-26-3. :REMOTEDisk:USERName	175
3-26-4. :REMOTEDisk:PASSWord	176
3-26-5. :REMOTEDisk:MOUNT	176
3-26-6. :REMOTEDisk:AUTOMount	176

3-26-1. :REMOTEDisk:IPADDRESS

Set →

→ Query

Description	Sets or returns the IP address of remote disk.
Syntax	:REMOTEDisk:IPADDRESS {<string> ?}
Parameter/ Return parameter	<string> IP address enclosed in double quotes. Eg., 172.16.20.255
Example	:REMOTEDisk:IPADDRESS "172.16.20.255" Sets the remote disk IP address as 172.16.20.255.

3-26-2. :REMOTEDisk:PATHName

Set →

→ Query

Description	Sets or returns the file path of the remote disk.
Syntax	:REMOTEDisk:PATHName {<string> ?}
Parameter/ Return parameter	<string> File path in enclosed in double quotes eg., "remote_disk"
Example	:REMOTEDisk:PATHName "remote_disk" Sets the file path to c:/remote_disk.

3-26-3. :REMOTEDisk:USERName

Set →

→ Query

Description	Sets or queries the account username for the remote disk.
Syntax	:REMOTEDisk:USERName {<string> ? }
Parameter/Return parameter	<string> User name enclosed in double quotes eg., "User_Name".
Example	:REMOTEDisk:USERName "User_Name" Sets the account name as User_Name.

3-26-4. :REMOTEDisk:PASSWord

Set →

→ Query

Description	Sets or queries the account password for the remote disk.
Syntax	:REMOTEDisk:PASSWord {<string> ? }
Parameter/Return parameter	<string> Username password enclosed in double quotes eg., "Password".
Example	:REMOTEDisk:PASSWord "Password" Sets the account password as Password.

3-26-5. :REMOTEDisk:MOUNT

Set →

→ Query

Description	Turns remote disk on/off or queries its state.
Syntax	:REMOTEDisk:MOUNT { OFF ON ? }
Parameter/Return parameter	OFF Unmount remote disk ON Mount remote disk
Example	:REMOTEDisk:IPADDRESS "172.16.5.154" :REMOTEDisk:PATHName "remote_disk" :REMOTEDisk:USERName "guest" :REMOTEDisk:PASSWord "password" :REMOTEDisk:MOUNT ON Sets the remote disk parameters and mounts the remote disk.

3-26-6. :REMOTEDisk:AUTOMount

Set →

→ Query

Description	Turns automount on/off or queries its state. The remote disk must be configured beforehand.
Syntax	:REMOTEDisk:AUTOMount { OFF ON ? }
Parameter/Return parameter	OFF Don't mount the remote disk at start up. ON Automatically mount the remote disk on start up.
Example	:REMOTEDisk:AUTOMount ON Turns the automount function on.

4. APPENDX

4-1. Error messages

The following error messages may be returned from the :SYSTem:ERROR? query.

No.	Description
0	"No error."
-100	"Command error"
-101	"Invalid character"
-102	"Syntax error"
-103	"Invalid separator"
-104	"Data type error"
-105	"GET not allowed"
-108	"Parameter not allowed"
-109	"Missing parameter"
-110	"Command header error"
-111	"Header separator error"
-112	"Program mnemonic too long"
-113	"Undefined header"
-114	"Header suffix out of range"
-115	"Unexpected number of parameters"
-120	"Numeric data error"
-121	"Invalid character in number"
-123	"Exponent too large"
-124	"Too many digits"
-128	"Numeric data not allowed"
-130	"Suffix error"
-131	"Invalid suffix"
-134	"Suffix too long"
-138	"Suffix not allowed"
-140	"Character data error"
-141	"Invalid character data"
-144	"Character data too long"
-148	"Character data not allowed"
-150	"String data error"
-151	"Invalid string data"
-158	"String data not allowed"
-160	"Block data error"
-161	"Invalid block data"
-168	"Block data not allowed"
-170	"Expression error"
-171	"Invalid expression"
-178	"Expression data not allowed"
-180	"Macro error"
-181	"Invalid outside macro definition"
-183	"Invalid inside macro definition"
-184	"Macro parameter error"

No.	Description
-200	"Execution error"
-201	"Invalid while in local"
-202	"Settings lost due to rtl"
-203	"Command protected"
-210	"Trigger error"
-211	"Trigger ignored"
-212	"Arm ignored"
-213	"Init ignored"
-214	"Trigger deadlock"
-215	"Arm deadlock"
-220	"Parameter error"
-221	"Settings conflict"
-222	"Data out of range"
-223	"Too much data"
-224	"Illegal parameter value"
-225	"Out of memory"
-226	"Lists not same length"
-230	"Data corrupt or stale"
-231	"Data questionable"
-232	"Invalid format"
-233	"Invalid version"
-240	"Hardware error"
-241	"Hardware missing"
-250	"Mass storage error"
-251	"Missing mass storage"
-252	"Missing media"
-253	"Corrupt media"
-254	"Media full"
-255	"Directory full"
-256	"File name not found"
-257	"File name error"
-258	"Media protected"
-260	"Expression error"
-261	"Math error in expression"
-270	"Macro error"
-271	"Macro syntax error"
-272	"Macro execution error"
-273	"Illegal macro label"
-274	"Macro parameter error"
-275	"Macro definition too long"
-276	"Macro recursion error"

No.	Description
-277	"Macro redefinition not allowed"
-278	"Macro header not found"
-280	"Program error"
-281	"Cannot create program"
-282	"Illegal program name"
-283	"Illegal variable name"
-284	"Program currently running"
-285	"Program syntax error"
-286	"Program runtime error"
-290	"Memory use error"
-291	"Out of memory"
-292	"Referenced name does not exist"
-293	"Referenced name already exists"
-294	"Incompatible type"
-300	"Device-specific error"
-310	"System error"
-311	"Memory error"
-312	"PUD memory lost"
-313	"Calibration memory lost"
-314	"Save/recall memory lost"
-315	"Configuration memory lost"
-320	"Storage fault"
-321	"Out of memory"
-330	"Self-test failed"
-340	"Calibration failed"
-350	"Queue overflow"
-360	"Communication error"
-361	"Parity error in program message"
-362	"Framing error in program message"
-363	"Input buffer overrun"
-365	"Time out error"
-400	"Query error"
-410	"Query INTERRUPTED"
-420	"Query UNTERMINATED"
-430	"Query DEADLOCKED"
-440	"Query UNTERMINATED after indefinite response"



TEXIO TECHNOLOGY CORPORATION

7F Towa Fudosan Shin Yokohama Bldg., 2-18-13, Shin Yokohama, Kohoku-ku,
Yokohama, Kanagawa, 222-0033, Japan.

<https://www.texio.co.jp/>
