

INSTRUCTION MANUAL

REGULATED DC POWER SUPPLY PDS-A SERIES

PDS20-10A	PDS20-18A	PDS20-36A
PDS36-6A	PDS36-10A	PDS36-20A
PDS60-6A	PDS60-12A	

OPTIONAL INTERFACE UNITS FOR PDS-A SERIES

IF-71RS	IF-70GU	IF-71LU
---------	---------	---------



■ **About Brands and Trademarks**

The company and product names described in this manual are the brands and trademarks owned by the respective companies or organizations in each country and region

■ **About the Instruction Manual**

Permission from the copyright holder is needed to reprint the contents of this manual, in whole or in part. Be aware that the product specifications and the contents of this manual are subject to change for the purpose of improvement.

CONTENTS

USING THE PRODUCT SAFETY	I - III
1. PDS-A SERIES	1
1-1. About This Manual	1
1-2. Outline of Product.....	1
1-3. Features.....	1
1-3-1. PDS-A Power Supply Unit	1
1-3-2. IF-71RS (option)	2
1-3-3. IF-70GU (option).....	2
1-3-4. IF-71LU (option)	2
1-3-5. Cable for master-slave operation (option).....	2
1-3-6. Handle (option)	2
2. PRIOR TO USE	3
2-1. Accessories	3
2-2. Connecting the power cable.....	4
2-3. Connecting to the output terminals	4
2-3-1. Attaching the output grounding cable	4
2-3-2. Connecting the voltage remote sensing cables	5
2-3-3. Attaching the rear output terminal cover	5
2-4. Caution on Connecting to a Capacitive Load.....	5
2-5. Connecting the protective grounding terminal on the bottom face	6
2-6. Caution on mounting the unit in a rack	6
2-7. Connecting the Power Cable to the Primary Power	6
2-8. Installation Environments	7
3. PANELS	8
3-1. Front Panel	8
3-2. Operation Panel.....	9
3-3. Rear Panel.....	12
4. GENERAL INSTRUCTIONS	15
4-1. Connecting loads.....	15
4-2. Alarm.....	16
5. FUNCTIONS AND OPERATION PROCEDURES	17
5-1. Operation modes	17
5-2. Turning On Power.....	17
5-2-1. Display when power is turned on	17
5-2-2. Performing a unit scan while using a parallel connection	17
5-2-3. Recalling Settings When Turning on Power, and Saving the Setting Data	18
5-3. Basic Operation	19
5-3-1. Voltage setting procedure.....	19
5-3-2. Current setting procedure.....	19
5-3-3. Fine adjustment of voltage/current	19
5-4. Output Functions	20
5-5. Memory Function.....	20
5-5-1. Storing and recalling preset voltage/current data.....	20
5-6. Switching the display in the Voltage/Current Indicator Display.....	21
5-6-1. Switching between the set voltage/current display and output voltage/current display.....	21

5-6-2. Displaying Power in the Voltage and Current Indicators.....	22
5-7. Protective Functions.....	24
5-7-1. Display when protective functions are activated.....	24
5-7-2. Modification of the Set Values of Protective Functions.....	24
5-7-3. Deactivating Protective Functions.....	25
5-8. Key Lock / Local Function.....	25
5-8-1. Key lock and unlock procedures.....	25
5-8-2. Remote mode deactivation procedure.....	26
6. SETTING WITH THE MENU KEY	27
6-1. Output Off Timer.....	28
6-1-1. Setting the output off timer.....	28
6-1-2. Operating the output off timer.....	29
6-2. Specifying the automatic cancellation time of the setting menu display.....	30
6-3. Specifying Settings when the Power Is Turned On.....	31
6-3-1. Recalling preset values when the power is turned on.....	31
6-3-2. Setting the output when the power is turned on.....	32
6-3-3. Setting the CC priority mode.....	33
6-3-4. Setting the display while the output is off.....	36
6-3-5. Default setting of the power relay when the power is turned on.....	37
6-3-6. Specifying the baud rate while in IF-71RS PDS mode.....	38
6-4. Clearing the Memory.....	39
6-4-1. Clearing all the setting data stored in the unit.....	39
6-4-2. Clearing the setting data for manual operation.....	40
6-4-3. Clear the setting data of sequence operation.....	41
6-4-4. Clearing the setting data for IF-71LU IP address setting.....	42
7. MASTER-SLAVE OPERATION	44
7-1. Configuration of Master and Slave Units.....	44
7-1-1. Configuring the master and slave units.....	44
7-1-2. Specifying the number of units.....	46
7-2. Parallel Master-Slave Operation.....	48
7-3. Serial Master-Slave Operation.....	49
8. SEQUENCE OPERATION	50
8-1. Setting of Sequence Operation.....	50
8-1-1. Turning on the power switch with sequence operation.....	50
8-1-2. Setting the unit to start in sequence operation by turning the power switch on.....	50
8-2. Sequence Programs.....	52
8-2-1. Step No. and setting items.....	52
8-2-2. Setting step execution.....	52
8-3. Confirming the Step No. and the Step Being Executed.....	53
8-3-1. Confirming the step No. while the sequence program is stopped.....	53
8-3-2. Confirming the step No. being executed during sequence program execution.....	53
8-4. Confirming the Setting Items for Steps.....	54
8-5. Confirming the settings for sequence program execution.....	55
8-6. Executing Sequence Programs.....	56
8-6-1. Automatic execution of sequence programs.....	56
8-6-2. Paused and resumed sequence programs.....	57

8-6-3. Manual execution of sequence programs	58
8-6-4. Stopping sequence programs.....	59
9. OPERATION BY EXTERNAL ANALOG SIGNAL	60
9-1. Analog Interface Boards	60
9-1-1. Cautions on applying analog IF boards.....	60
9-1-2. Wiring an analog signal to the standard board.....	61
9-2. Operating the Analog IF Board.....	63
9-2-1. Setting the Voltage	63
9-2-2. Adjusting the set voltage.....	65
9-2-3. Current setting	66
9-2-4. Adjusting the set current	68
9-2-5. Turning the output on/off through external contacts.....	69
9-2-6. Checking the status when the output is off	71
9-2-7. Main relay ON/OFF operation	71
10. INTERFACE OPTION	72
10-1. Accessories	72
11. USING DIGITAL COMMUNICATION INTERFACE FOR REMOTE CONTROL	73
11-1. Outline.....	73
11-1-1. IF-70GU	73
11-1-2. IF-71LU	74
11-1-3. IF-71RS.....	75
11-1-4. Cable and connector settings.....	76
11-1-5. Address settings	77
11-1-6. Checking the mode and address settings of the interface card.....	79
11-1-7. GP-IB connection	80
11-1-8. USB connection.....	80
11-1-9. RS-232C connection	81
11-1-10. LAN connection	81
11-1-11. Local bus connection	82
11-2. Communication Control Commands	83
11-2-1. Communication commands table.....	83
11-2-2. Automatic message output.....	84
11-2-3. Command format.....	84
11-3. Commands	86
11-3-1. Voltage setting (VOLT).....	86
11-3-2. Current setting (AMP)	86
11-3-3. OVP setting (OVP)	86
11-3-4. UVP setting (UVP).....	86
11-3-5. OCP setting (OCP)	86
11-3-6. Output setting (OUTPUT)	87
11-3-7. Status query (XSTATUS)	87
11-3-8. Recalling preset settings (PRESET)	87
11-3-9. Saving preset settings (SETPRE)	87
11-3-10. Preset voltage setting (PREVOLT).....	88
11-3-11. Preset current setting (PREAMP).....	88
11-3-12. Power monitor display setting(MONDSP)	88

11-3-13. Power-off display setting(DSPY)	88
11-3-14. Monitor display switching (CHECK)	89
11-3-15. CC priority mode setting when the output is turned on (CCPRIO)	89
11-3-16. Output off timer setting (OFFTM)	89
11-3-17. Automatic cancellation time setting for the setting menu display (ESC)	89
11-3-18. Main relay setting (POWER).....	90
11-3-19. Unlocking (GTL)	90
11-3-20. Local lock out setting (LLO)	90
11-3-21. Sequence operation setting when the power is turned on (PONSEQ).....	90
11-3-22. Preset setting when the power is turned on (PONPRE)	90
11-3-23 Output setting when the power is turned on (PONOUT).....	91
11-3-24. Main relay setting when the power is turned on (PONPOW)	91
11-3-25. Notification setting 1 (MASK)	91
11-3-26. Notification setting 2 (AMASK).....	92
11-3-27. Notification setting 3 (SMASK).....	92
11-3-28. Querying alarm status (ALM)	92
11-3-29. Alarm reset (EXIT_ALM).....	92
11-3-30. Clearing sequence programs (SCLR)	92
11-3-31. Writing sequence program (XSWRITE)	93
11-3-32. Reading out a sequence program (XSREAD).....	94
11-3-33. Sequence start point setting (SSADR)	94
11-3-34. Sequence end point setting (SEADR).....	94
11-3-35. Sequence execution mode setting (SMODE).....	95
11-3-36. Sequence repeat cycle setting (SCYCLE).....	95
11-3-37 Sequence mode setting (CHGSEQ)	95
11-3-38. Panel operation mode setting (CHGNORM)	95
11-3-39. Sequence start (SSTART)	95
11-3-40. Sequence stop (SSTOP)	95
11-3-41. Sequence pause (SPAUSE)	96
11-3-42. Sequence jump (SSTEP).....	96
11-3-43. Reading out the sequence execution status (SRUN).....	96
11-3-44. Reset (*RST).....	96
11-3-45. Function reset (RESET).....	96
11-3-46. Reading out the status byte (*STB).....	97
11-3-47. Reading out the product information (*IDN).....	97
11-3-48. Querying the model and specifications (MODEL).....	97
11-3-49. Local bus setting (ADRS).....	98
11-3-50. Returning the product name of the unit (UNIT?).....	98
11-3-51. Query-dedicated PC address for device identification (LPCAD?)	98
11-4. Cautions about communication	99
11-5. Compatibility of PDS-A series and PDS series.	99
11-6. Communication Specifications	100
Appendix A. TROUBLE SHOOTING	104
Appendix B. OUTSIDE DIMENSIONS	105
Appendix C. SPECIFICATIONS	106

USING THE PRODUCT SAFELY

■ Preface

To use the product safely, read instruction manual to the end.

Before using this product, understand how to correctly use it.



If you read the manuals but you do not understand how to use it, ask us or your local dealer.

After you read the manuals, save it so that you can read it anytime as required.

■ Pictorial indication

The manuals and product show the warning and caution items required to safely use the product.

The following pictorial indication and warning character indication are provided.

<Pictorial indication>	
	<p>Some part of this product or the manuals may show this pictorial indication. In this case, if the product is incorrectly used in that part, a serious danger may be brought about on the user's body or the product. To use the part with this pictorial indication, be sure to refer to the manuals.</p>
 	<p>If you use the product, ignoring this indication, you may get killed or seriously injured. This indication shows that the warning item to avoid the danger is provided.</p> <p>If you incorrectly use the product, ignoring this indication, you may get slightly injured or the product may be damaged. This indication shows that the caution item to avoid the danger is provided.</p>

Please be informed that we are not responsible for any damages to the user or to the third person, arising from malfunctions or other failures due to wrong use of the product or incorrect operation, except such responsibility for damages as required by law.

USING THE PRODUCT SAFELY



■ Do not remove the product's covers and panels

Never remove the product's covers and panels for any purpose. Otherwise, the user's electric shock or fire may be incurred.

■ Warning on using the product

Warning items given below are to avoid danger to user's body and life and avoid the damage or deterioration of the product. Use the product, observing the following warning and caution items.

■ Warning items on power supply

● Power supply voltage

The rated power supply voltages of the product are 100, 230 and 240VAC. The rated power supply voltage for each product should be confirmed by reading the label attached on the back of the product or by the "rated" column shown in the instruction manual. The specification of power cord attached to the products is rated to 125VAC for all products which are designed to be used in the areas where commercial power supply voltage is not higher than 125VAC. Accordingly, you must change the power cord if you want to use the product at the power supply voltage higher than 125VAC. If you use the product without changing power cord to 250VAC rated one, electric shock or fire may be caused. When you used the product equipped with power supply voltage switching system, please refer to the corresponding chapter in the instruction manuals of each product.

● Power cord

(IMPORTANT) The attached power cord set can be used for this device only.

If the attached power cord is damaged, stop using the product and call us or your local dealer.

If the power cord is used without the damage being removed, an electric shock or fire may be caused.

● Protective fuse

If an input protective fuse is blown, the product does not operate. For a product with external fuse holder, the fuse may be replaced. As for how to replace the fuse, refer to the corresponding chapter in the instruction manual.

If no fuse replacement procedures are indicated, the user is not permitted to replace it. In such case, keep the case closed and consult us or your local dealer. If the fuse is incorrectly replaced, a fire may occur.

■ Warning item on Grounding

If the product has the GND terminal on the front or rear panel surface, be sure to ground the product to safely use it.

■ Warnings on Installation environment

● Operating temperature and humidity

Use the product within the operating temperature indicated in the "rating" temperature column.

If the product is used with the vents of the product blocked or in high ambient temperatures, a fire may occur.

Use the product within the operating humidity indicated in the "rating" humidity column.

Watch out for condensation by a sharp humidity change such as transfer to a room with a different humidity.

Also, do not operate the product with wet hands. Otherwise, an electric shock or fire may occur.

● Use in gas

Use in and around a place where an inflammable or explosive gas or steam is generated or stored may result in an explosion and fire. Do not operate the product in such an environment.

Also, use in and around a place where a corrosive gas is generated or spreading causes a serious damage to the product. Do not operate the product in such an environment.

● Installation place

Do not insert metal and inflammable materials into the product from its vent and spill water on it.

Otherwise, electric shock or fire may occur.

USING THE PRODUCT SAFELY

■ Do not let foreign matter in

Do not insert metal and inflammable materials into the product from its vent and spill water on it. Otherwise, electric shock or fire may occur.

■ Warning item on abnormality while in use

If smoke or fire is generated from the product while in use, stop using the product, turn off the switch, and remove the power cord plug from the outlet. After confirming that no other devices catch fire, ask us or your local dealer.

■ Input / Output terminals

Maximum input to terminal is specified to prevent the product from being damaged.

Do not supply input, exceeding the specifications that are indicated in the "Rating" column in the instruction manual of the product. Also, do not supply power to the output terminals from the outside.

Otherwise, a product failure is caused.

■ Calibration

Although the performance and specifications of the product are checked under strict quality control during shipment from the factory, they may be deviated more or less by deterioration of parts due to their aging or others.

It is recommended to periodically calibrate the product so that it is used with its performance and specifications stable.

For consultation about the product calibration, ask us or your local dealer.

■ Daily Maintenance

When you clean off the dirt of the product covers, panels, and knobs, avoid solvents such as thinner and benzene. Otherwise, the paint may peel off or resin surface may be affected. To wipe off the covers, panels, and knobs, use a soft cloth with neutral detergent in it.

During cleaning, be careful that water, detergents, or other foreign matters do not get into the product.

If a liquid or metal gets into the product, an electric shock and fire are caused.

During cleaning, remove the power cord plug from the outlet.

Use the product correctly and safely, observing the above warning and caution items.

Because the instruction manual indicates caution items even in individual items, observe those caution items to correctly use the product.

If you have questions or comments about the manuals, ask us or E-Mail us.

1. PDS-A SERIES

1-1. About This Manual

This manual applies to the following PDS-A series power supply units and optional interface units.

- PDS-A series:

Rated Voltage	Rated Current			
	200W	216W	360W	720W
20V	PDS20-10A	-	PDS20-18A	PDS20-36A
36V	-	PDS36-6A	PDS36-10A	PDS36-20A
60V	-	-	PDS60-6A	PDS60-12A

- Optional interface units for the PDS-A series
IF-71RS, IF-70GU, IF-71LU

1-2. Outline of Product

This product is a small, light-weight, and low-noise DC power supply unit equipped with a switching system and dropper system. It is incredibly reliable and comes with a variety of protective functions, making it ideal for use as a power source in industrial applications, such as the reliability tests, durability tests, and aging of electronic parts.

This power supply unit has a 3-point preset function as well as protective functions for overvoltage, undervoltage, and overcurrent. It is also equipped with an output off timer, sequence function, CC priority mode for when the output is on, and an external analog signal operation function. This wide range of functions enables this power supply unit to be used for a variety of application. In addition, the unit is designed to minimize the harmonic current of the power supply, which exerts a harmful influence on the AC line.

The standard analog control board is to be replaced with an optional interface board equipped with communication functions. There are three available models of optional boards (the IF-71RS, IF-70GU, and IF-71LU).

1-3. Features

1-3-1. PDS-A Power Supply Unit

- **Low ripple and low noise**

A series transistor is used for output voltage control to minimize the output ripple and noise.

- **Selection of setting digits for voltage and current setting**

The output voltage and current are indicated by 4 digits. You can select a digit to set the voltage and the current.

The PDS-A power supply unit is also equipped with a fine adjustment function for instances in which more precise setting capabilities are required.

- **Preset function**

The unit has a preset memory for 3 setting points in which different voltage and current settings can be stored. This function enables you to easily change the voltage and current settings.

- **Output off timer function**

To prevent battery overcharge etc., this function automatically turns the output off after a preset amount of time has passed while the output is on.

- **CC priority mode**

Compared to general switching power supply units, the PDS-A power supply unit is better able to reduce current overshoot, thanks to our original current-overshoot inhibit circuit. This circuit produces a load that enables the unit to operate at a constant current while the output is on.

- **Sequence function**

Sequence programs can be written in the unit from a computer via the optional interface board (IF-71RS, IF-70GU, and IF-71LU).

Sequence programs can be executed by performing panel or computer operations.

You can also perform sequence operations with a maximum of 1000 steps by using a program written by the computer. The minimum step unit is 50ms.

- **Remote sensing function**

This function uses the remote sensing terminal to compensate for voltage drop caused by the wires.

- **Protective functions**

The unit is equipped with functions designed to protect the power supply, such as overvoltage, undervoltage, and

overcurrent on the primary side, as well as overvoltage, overcurrent, internal overheat, and front output overvoltage on the secondary side.

The unit is also equipped with OVP (over-voltage protection), UVP (under-voltage protection), and OCP (over-current protection) for the load. The setting values for these protective functions are changeable.

- **Master-slave operation**

The PDS-A power supply unit can perform master-slave operation by connecting three units of the same model in a parallel connection, and up to two units in the serial connection.

- **External analog signal operation**

When setting the voltage and current by external voltage and resistance, the setting values set externally will be superimposed on the setting values set on the panel.

The external setting values can be adjusted on the panel.

The output can be turned on and off by entering external terminal.

- **Dispersion circuit for rush current prevention**

The PDS-A power supply unit is able to restrain and minimize the primary side current and voltage distortions caused by rush current on the primary side at the time the unit is switched on, thanks to the main relay's on/off operation and our original dispersion circuit for rush current prevention.

- **Power factor correction circuit, as well as voltage and current range for worldwide use**

The PDS-A power supply unit is equipped with a power factor correction circuit that has a rated output of approximately 0.99.

It is operable with supply voltages ranging from 100VAC to 240VAC, without changing the settings.

- **Forced air cooling via front air intake**

The front of the PDS-A power supply unit is equipped with a cooling fan motor. This helps to lower the ambient temperature around the fan motor and improve its reliability.

- **CE marking**

The PDS-A power supply unit can perform CE marking (under voltage directive, EMC directive). It also complies with the regulations for the harmonic current of power supply units.

1-3-2. IF-71RS (option)

- Units equipped with the IF-71RS can be connected to a computer and controlled by RS-232C.
As an expansion, the IF-71RS can also control 31 PDS-A power supply units via a local bus connection.
- When you set IF-71RS in PDS communication mode, you can let PDS-A power supply work by PDS power supply communication command.

1-3-3. IF-70GU (option)

- The IF-70GU is connected to a computer through a GP-IB or USB.
Fourteen units may be connected with a computer through GP-IB, or 32 units may be connected through USB.
- Units connected to the computer can be connected with 31 PDS-A power supply units via a local bus connection.

1-3-4. IF-71LU (option)

- A LAN or USB can be used to connect to a computer.
A total of 32 units can be connected to the computer via a USB.
- A total of 31 PDS-A power supply units can be connected via a local bus to the unit that is connected to the computer.

1-3-5. Cable for master-slave operation (option)

- Cable for parallel master-slave OP-23P3 : Connectable with three PDS-A power supply units.
- Cable for in-series master-slave OP-23S : Connectable with two PDS-A power supply units.



**When connecting cables, make sure to connect the correct cables.
Connecting the wrong cables may cause product failure.**

1-3-6. Handle (option)

- HK-11 : Attachable with this models

2. PRIOR TO USE

2-1. Accessories

Make sure the accessories are attached correctly. If there are any problems, please contact one of our sales branches. Accessories vary by model.

<PDS-A series power supply unit accessories>

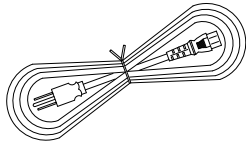

Power cable: 1 pc
For 125V: [E30-5632]
For 250V: [E30-5643]

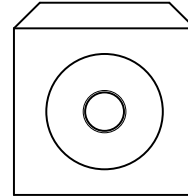

CD-ROM (Manual) 1 pc

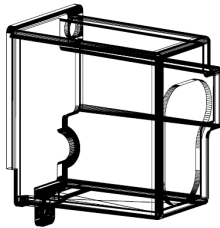

Rear output terminal cover: [F07-1586] 1 pc
◆ See [“2-3-3. Attaching the rear output terminal cover”](#).

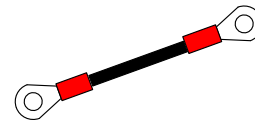

Output ground cable: [E38-3353] 1 pc
◆ See [“2-3-1. Attaching the output grounding cable”](#).

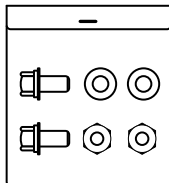

Contents:
Hexagon head bolt (P-3): 2 pcs
Flat washer : 2 pcs
Hexagon nut : 2 pcs

Bolts set: [N99-0416] 1 set
For connecting load line to rear output terminal.
◆ See [“2-3. Connecting to the output terminals”](#).

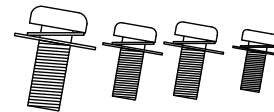

M3 Small screw washer : [N67-3006-41] 1 set
Used to fix the ground cable to the rear output terminal.
◆ See [“2-3-1. Attaching the output grounding cable”](#).

M3 Large screw washer : [N66-3008-41] 2 sets
Used to attach the rear output terminal cover.
◆ See [“2-3-3. Attaching the rear output terminal cover”](#).

M4 Small screw washer : [N67-4008-41] 1 set
Used to connect the bottom protective grounding terminal.
◆ See [“2-5. Connecting the protective grounding terminal on the bottom face”](#).

* The cushion for the ferrite core is not included with the 1200W power cable: [E30-5637].

2-2. Connecting the power cable

The power cable should be connected to an AC inlet or an input terminal block. Make sure to use a power cable that matches the input voltage of the unit. Because the voltage rating of the supplied power cable is 125VAC, you must use a different cable when a power voltage greater than 125VAC is used.



Make sure to properly connect the power cable. Failure to do so may result in electric shock or fire.

Using the unit without the AC input terminal cover may result in electric shock or fire.

Perform this operation before connecting the power cable to an AC outlet or the distribution panel.

2-3. Connecting to the output terminals

Use the supplied bolt set to connect the load cable to the rear output terminals.

Adjust the tightening torque of each bolt to 25 kgf/cm.

Check the connection between the load and the output terminals of the unit. Make sure that the polarity is not inverted, and that no short circuits have occurred.

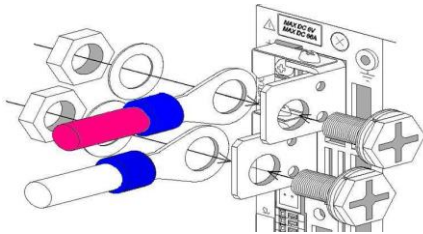

Attach a round crimp-style terminal (inner diameter of at least 6.4 mm) to the load cable.

Insert the bolt into the hole from left side of the output terminal.

From the right side of the output terminal, first attach the load cable (with the round crimp-style terminal attached), followed by the washer and then the nut. Finally, secure the bolt.

Fig. 2-2 Connecting the load cable to the rear output terminals



Make sure the voltage of the unit's output terminals has sufficiently fallen before touching and operating the load or output terminals. Failure to do so may result in electric shock.

2-3-1. Attaching the output grounding cable

(You do not need to perform this operation if the output is not to be grounded.)

Use the M3 Small screw and washer to attach the grounding cable to one of the rear output terminals.

Tightening torque of screw: 5kgf/cm.

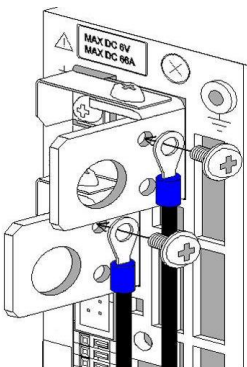

From the left side of the rear output terminals, attach the grounding cable to the M3 hole of one of the output terminals.

Attach the grounding cable to either the positive output terminal or the negative output terminal. Do not attach the cable to both.

If you attach the grounding cable to both the positive and negative output terminals, the unit output will short circuit.

2-3-2. Connecting the voltage remote sensing cables

You only need to perform this operation if you plan to use the voltage remote sensing function of the unit.
Use the removed M3 screws to attach the voltage remote sensing cables to the voltage remote sensing terminals.
Tightening torque of screw: 5kgf/cm
Carefully store the positive and negative shorting bars and the two M3 screws that were removed.

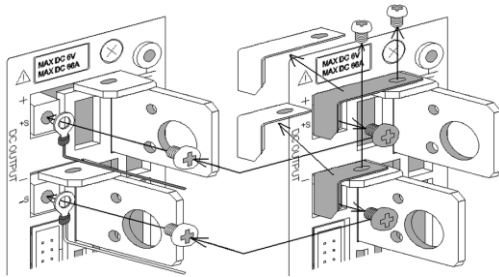

Remove the M3 screws (4 screws) from the positive and negative rear output terminals and the positive and negative voltage remote sensing terminals, and then remove the positive and negative shorting bars.

Attach the positive and negative voltage remote sensing cables to the positive and negative voltage remote sensing terminals.

Attach a round crimp-style terminal (inner diameter of at least 3.2mm, with the smallest possible outer diameter) to the voltage remote sensing cables.

2-3-3. Attaching the rear output terminal cover

The rear output terminal cover should always be attached even when rear output terminals of the unit are not in use.
Use the M3 Large screw with washer to attach the rear output terminal cover.
Tightening torque of screw: 5kgf/cm.

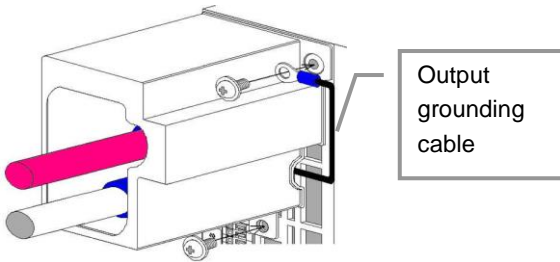

Run the load cable and the voltage remote sensing cable through the output terminal cover, and then fix the output terminal cover to the unit, using the two large screws with washers.

Fix the output grounding cable to the output grounding terminal, together with the output terminal cover.

2-4. Caution on Connecting to a Capacitive Load

To maintain an output voltage of approximately 0 V when the output is off, the unit is equipped with a discharge circuit for removing the electric charge from the output capacitor.

When the output is off, it takes approximately 1 second for the discharge circuit to remove the electric charge from the output capacitor when the capacitor is fully charged to its rated voltage.

If a capacitive load, such as a battery or capacitor, is connected to the unit and used, it takes longer to lower the output voltage when the output is off. If the output is turned off while a capacitive load is connected, be sure to use a voltmeter to confirm that the voltage has sufficiently fallen before touching the output terminal or the load.

The discharge circuit for the output capacitor does not work if the unit's output HI-R function is used.

Compared to when the output HI-R function is not used, it takes longer for voltage to fall when a capacitive load is used.

2-5. Connecting the protective grounding terminal on the bottom face

There is a protective grounding terminal on the bottom face of this unit.

To ensure the safe use of this product, follow the procedure below to connect the protective grounding terminal.

1. Attach the wire (recommended by the manufacturer) for round crimp-style terminals V1.25-M4 (JST) or equivalent.
2. Attach the round crimp-style terminal to the cable.
3. Attach the cable with round crimp-style terminal to the protective grounding terminal on the bottom face of the unit, using the accessory M4 screw for the grounding connection to secure the cable.

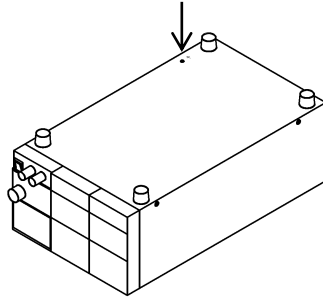

WARNING

Make sure to properly connect the protective grounding terminal on the bottom face. Failure to do so may result in electric shock. If you do not connect the protective grounding terminal on the bottom face, it will come off from the CE conformity.

2-6. Caution on mounting the unit in a rack

When mounting the unit in a rack, use one of the following attachments:

- Rack mount adapter RM-608J (for JIS rack)
- RM-608E (for EIA rack) and rack mount frame attachment RJ-608-1/2 (for 1/2 rack width)
- RJ-608-1/3 (for 1/3 rack width)

When mounting the unit in a rack, replace the screws on the left and right sides of the unit (two on each side) with the flat countersunk head screws (N32-3006-41) that are included with RJ-608-1/2 or RJ-608-1/3.

When mounting the unit in a rack, remove the screw for the protective grounding terminal on the bottom face of the unit. For your own safety, make sure to securely connect the rack to the ground before using the unit.

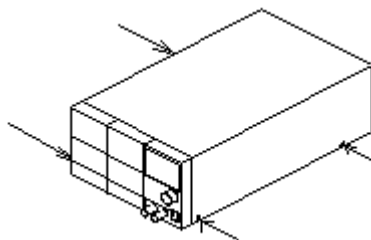

2-7. Connecting the Power Cable to the Primary Power

Be sure to turn off the power switch before connecting the power cable to the AC outlet or distribution panel.

Because the voltage rating of the supplied power cable is 125VAC, you must use a different cable when a power voltage greater than 125VAC is used.

Make sure to plug the supplied power cable into a D-class grounded AC outlet.



WARNING

Plugging the power cable into an outlet or distribution panel that is not properly grounded may result in electric shock or fire. Be sure to ask a qualified engineer to connect the power cable to the distribution panel.

2-8. Installation Environments

- If the unit is used in a hot place and the internal temperature of the unit rises, the built-in overheat protection circuit activates and turns off the output. Do not use the unit in a location where the grill in the front panel or air outlet port in the rear panel is blocked. Blocking these ports will cause the internal temperature to rise. Maintain sufficient distance between these ports and objects. In some conditions, hot air may blow out of the air outlet port in the rear panel. Be careful.
- Do not use the PDS-A power supply unit in a place with a lot of dust or corrosive gas. These substances can cause the product to deteriorate.
- Do not use the unit on an incline or a place subject to vibration. Doing so can cause the unit to fall off the rack or fall over, which may result in damage to the unit or personal injury.

3. PANELS

3-1. Front Panel

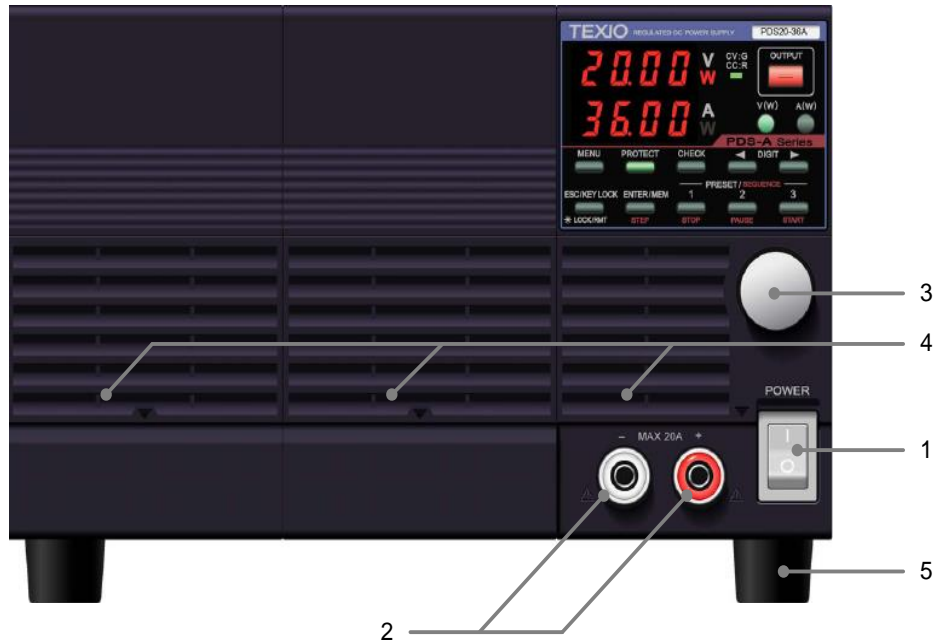

Fig. 3-1 Front Panel (The above figure shows the front panel of the PDS20-36A.)

1. Power switch

- Turns the AC power on (I) and off (O).
- Do not do the setting that comes to have difficulty in ON/OFF of the power switch.

2. Front output terminals

- Front output terminals with a current limit of 20A. Use the unit within the current limit

3. Rotary encoder

- Changes the set voltage and current, and is used to set functions.

4. Grill

- Air intake port.

Push up the ▽ mark in the bottom center of the grill to detach the cover when cleaning or replacing the dust filter inside.

5. Rubber shoes

- Detachable.

If the unit is mounted in a rack and the shoes are not needed, they may be removed.

3-2. Operation Panel

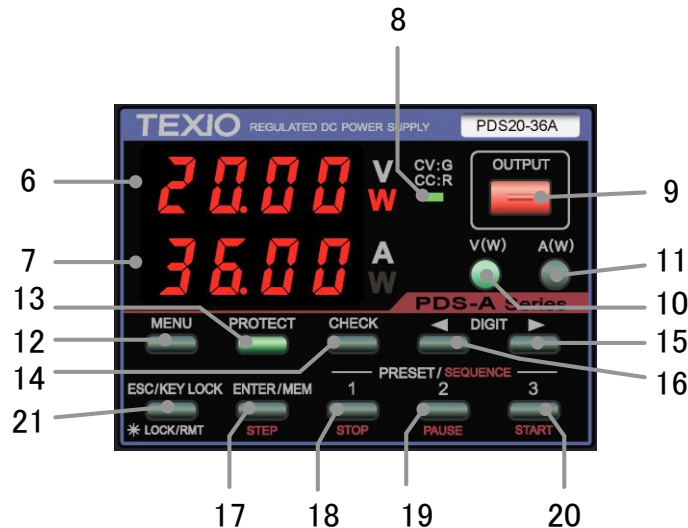

Fig.3-2 Operation Panel
(The above figure shows the operation panel of the PDS20-36A.)

- 6. Voltage indicator (red LEDs): 4-digit display, unit indication
 - Indicates the set voltage, output voltage, output power, and MENU items.
 - “W” is lit in red when the indicator displays the output power.
- 7. Current indicator (red LEDs): 4-digit display, unit indication
 - Indicates the set current, output current, output power, and MENU items.
 - “W” is lit in red when the indicator displays the output power.
- 8. CV/CC LED (green/red)
 - When the output is on, the LED is lit in green when CV is in operation, and red when CC is in operation.
 - Turns off when output is off. It blinks red when the CC priority mode is selected.
- 9. OUTPUT key (red/amber)

Manual operation

 - Lit in red when the output is on.
 - Alternately blinks red and amber when the output off timer is set and the output is on.
 - Pressing this key turns the output on and off.
 - It is not possible to turn the output on and off when the MENU key is lit in green.

Sequence operation

 - If this key is pressed while a sequence manual/automatic operation is being executed, the output will turn off and the sequence will be interrupted.
- 10. V key (green/amber)

The voltage is set by operating this front panel key

 - Pressing this key causes it to turn off or light in green.
 - When this key is lit in green, it is possible to change the blinking digit of the set voltage in the voltage indicator.
 - Pressing and holding down this key switches the voltage display to the power display. Pressing and holding down this key again switches the display back to the voltage display.
 - The key is lit in amber when the voltage is set by external analog signals.
- 11. A key (green/amber)

The current is set by operating this front panel key

 - Pressing this key causes it to turn off or light in green.
 - When the key is lit in green, it is possible to change the blinking digit of the set current in the current indicator.
 - Pressing and holding down this key switches the current display to the power display. Pressing and holding down this key again switches the display back to the current display.
 - The key is lit in amber when the current is set by external analog signals.

12. MENU key (green)

Manual operation

- Able to operate and confirm the MENU setting or selection when this key is lit in green.
- Unable to configure the MENU setting when the output is on.

Sequence operation

- This key lights in green when it is pressed, and the voltage and current indicators display the setting of the sequence steps to be executed.

13. PROTECT key (green)

- Pressing this key when it is turned off sets OVP (over-voltage protection).
- When this key is lit, OVP (over-voltage protection), UVP (under-voltage protection), and OCP (over-current protection) can be selected and set. Press the ESC key to finish setting the protections.

14. CHECK key (green)

Manual operation

- When this key is lit, the voltage and current indicators display the set voltage and current. When it is not lit, the indicators display the output voltage and current.
In the power indication, the voltage and current indicators display "- - -".
- Pressing this key displays the output voltage/current and the set voltage/current alternately.
Operate the MENU key to display the output voltage and current when the output is off.

Sequence operation

- Changes the voltage and current indicators from the sequence steps to the output voltage and current, and vice versa.
- The sequence steps are displayed when this key is lit, and the output voltage and current are displayed when it is not lit.

15. DIGIT KEY ◀

Manual operation

- Pressing this key moves the digit of the set voltage, current, OVP, UVP, or OCP value to be changed to the left.

Sequence operation

- Returns to the previous step while the sequence program is being executed.
- If this key is pressed when execution is stopped, the execution STEP can be set to the START STEP (execution mode: 0 and 1) and the END STEP (execution mode: 2 and 3) in the sequence program.

16. DIGIT KEY ▶

Manual operation

- Pressing this key moves the digit of the set voltage, current, OVP, UVP, or OCP value to be changed to the right.

Sequence operation

- Moves forward to the next step while the sequence program is being executed.
- If this key is pressed when execution is stopped, the execution STEP can be set to the END STEP (execution mode: 0 and 1) and the START STEP (execution mode: 2 and 3) in the sequence program.

17. ENTER/MEM/STEP key (green/amber)

Manual operation

- Memory function : Pressing this key causes the PRESET 1, 2, and 3 keys to blink, and places the memory on standby to store the setting.
Pressing this key again cancels the memory's standby state.
- Initialization : Pressing and holding down this key then turns power on the unit and initializes the data stored in the unit.

Sequence operation

- This key lights in green. Pressing this key again causes it to light in amber, and the voltage and current indicators display the STEP value.

18. PRESET 1/STOP key (green/amber)

Manual operation

- Stores and reads out the set voltage and current.
- When this key blinks green, it is on standby to store the setting. When it is lit in green, it reads out the data stored in PRESET 1.

Sequence operation

- Lit in amber during the sequence operation. Pressing this key stops the execution of the sequence program.

19. PRESET 2/PAUSE key (green/amber)

Manual operation

- Stores and reads out the set voltage and current.
- When the key blinks green, it is on standby to store the setting. When it is lit green, it reads out the data stored in PRESET 2.

Sequence operation

- Lit in amber during the sequence operation. Pressing this key suspends the execution of the sequence program.

20. PRESET 3/START key (green/amber)

Manual operation

- Stores and reads out the set voltage and current.
- When the key blinks green, it is on standby to store the setting. When it is lit in green, it reads out the data stored in PRESET 3.

Sequence operation

- Lit in amber during the sequence operation. Pressing this key starts the execution of the sequence program.

21. ESC/KEYLOCK LOCK/RMT key (green)

- Lit in green when the unit is in remote operation or key lock state. When this key is lit, the unit cannot be operated from the front panel (although the OUTPUT key can still be operated).
- ESC function: Pressing this key cancels the display of the voltage/current setting, OVP/UVP/OCP setting, MEMORY setting, and MENU setting.
- Pressing and holding this key while it is lit in green cancels remote operation or key lock. After remote operation or key lock is cancelled, the light turns off.
- Pressing and holding this key while the light is off locks the key. After the key is locked it lights in green.

3-3. Rear Panel

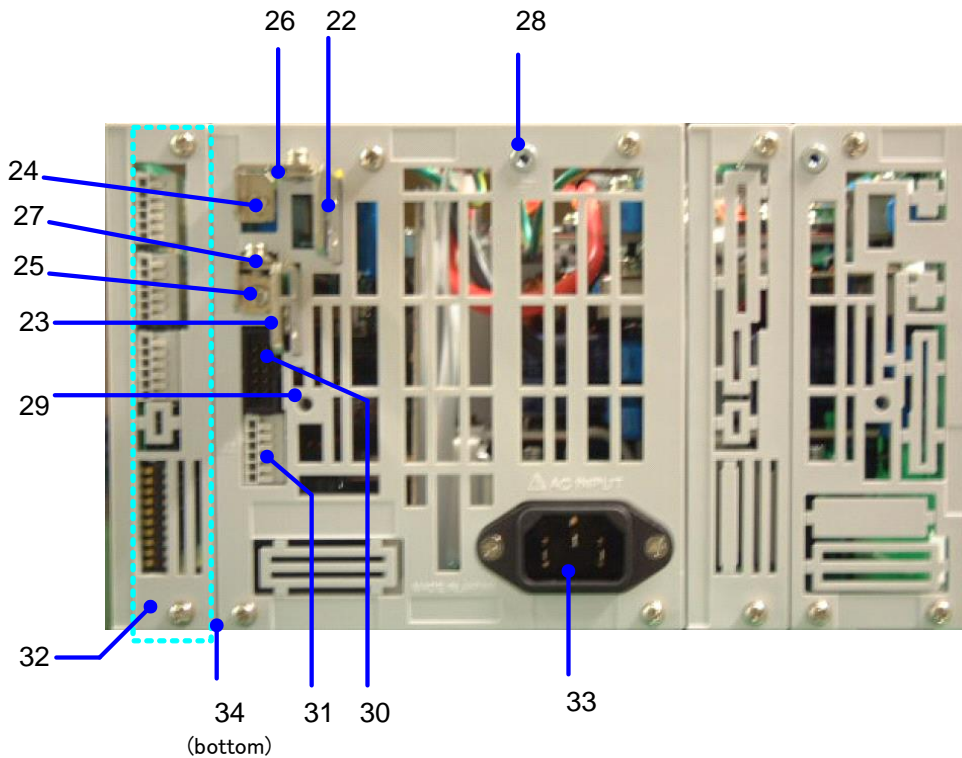

Fig. 3-3 Rear Panel

(The above figure shows the rear panel of the PDS20-36A (720W model).)

22,23. Output terminals

- Output terminals of the PDS-A series power supply unit. 22: Positive output, 23: Negative output
Use the supplied bolt set when connecting to the load cable.
- Voltage is output from the rear output terminals even when the front output terminals are used.
Be sure to attach the supplied rear output terminal cover to the unit when the rear output terminals are used.
The rear output terminal cover should be fixed at the following two points: the output terminal grounding terminal (28) and the output terminal cover attachment hole (29)

24,25. Remote sensing terminals

- Remote sensing terminals of the PDS-A series power supply unit. 24: Positive terminal, 25: Negative terminal
To use the remote sensing function, remove the shorting bars (26 and 27).
- When using the remote sensing function, connect the positive remote sensing terminal (24) to the part where the positive output terminal of the load is connected, and the negative remote sensing terminal (25) to the part where the negative output terminal of the load is connected.
Incorrectly connecting the terminals may damage the unit or apply overvoltage to the load.

26,27. Shorting bars

Short-circuits the output terminals and remote sensing terminals.

25: Positive shorting bar 26: Negative shorting bar

When the remote sensing function is not used, attach the shorting bars to the output terminals and remote sensing terminals to operate the unit. Failure to securely attach the short bar may cause the output to become unstable.

28. \perp Output grounding terminal

- Used to ground the positive or negative output terminal of the unit.
Use the output ground cable to ground output terminals.
- This terminal is also used to fix the output terminal cover.

29. Output terminal cover attachment hole

- Used to fix the output terminal cover.
Use the supplied M3 Large screws with washers.

30. J1 connector

- Used for master-slave operation.
The parallel master-slave cable and series master-slave cable are different. Use the cable appropriate for the operation.



**Do not connect any cables other than the master-slave cable.
Connecting other cables may damage the unit.**

31. J2 connector

- The connector for the monitor output of the unit output and the slave control signal input for series master-slave operation.
The terminal is a screw-less connector.
Use AWG24 – 26 cables to connect.

No.	Description
1	Output current monitor output: Output current 0A → Rated current approx.0V → Output 10V.
2	Output voltage monitor output: Output voltage 0V → Rated voltage approx. 0V → Output 10V.
3	Common terminal for 1 and 2. The terminal is connected to the negative output terminal.
4	When the unit is used as the slave machine for series master-slave operation, connect to the negative output terminal of the master machine.
5,6	Not used. Do not connect anything to these terminals because they are for internal connection.

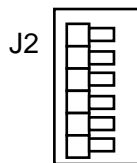

Fig3-4. J2 connector's pin No.

32. Interface slot

- An analog signal control unit (hereinafter standard board) is equipped as standard.
- The standard board can be replaced with an interface board (hereinafter IF board) that controls the unit via external signals.

Remove the two upper and lower screws from the marked area to install the IF board. Make sure to refasten the two upper and lower screws after installing the board.

If the upper and lower screws are not fastened, contact failure between the unit and IF board may cause the unit to malfunction.

33. AC inlet

- Use the supplied power cable. Connect the power cable to the AC outlet.
- If the supplied power cable is used, the AC input voltage range of the unit will be 125V or lower (products for Japan only).

AC inlet

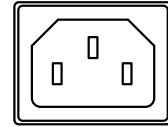

Supplying AC power to the unit that exceeds the specified input range may result in failure, electric shock, or fire.
Performing wiring work while the power cable is connected to the AC outlet or distribution panel may result in electric shock or fire.



For optimal air ventilation, maintain a distance of at least 30cm between the rear panel and nearby objects.
If the rear panel is blocked, the internal temperature may rise.

34. Protective grounding terminal

The product is equipped with a protective grounding terminal on the bottom face. For your own safety, make sure to connect the unit to ground before use.

- ◆ See [“2-5. Connecting the protective grounding terminal on the bottom face”](#) for details.



Make sure to properly connect the protective grounding terminal on the bottom face. Failure to do so may result in electric shock.
If you do not connect the protective grounding terminal on the bottom face, it will come off from the CE conformity.

4. GENERAL INSTRUCTIONS

4-1. Connecting loads

- When connecting loads to the unit, use round crimp-style terminals, etc. to ensure loads are securely connected to the output terminals.
- Use cables that have sufficient current capacity for the wiring to be connected.
- Be sure to turn off the unit (output off) before connecting or disconnecting cables to and from the wiring.
- The unit is equipped with a capacitor of several thousands of μF that is connected to output terminals, and a circuit for discharging the charged capacitor while the unit is turned off (output off).

The unit also features the HI-R function for cutting off the discharge circuit. However, low-ampere current flows through the circuit of the voltage monitor, etc. When the battery is charged and the unit is turned off (output off), the low-ampere current causes the voltage of the battery to fall.

When the unit is used for charging batteries or a similar purpose, to prevent the load from discharging to the unit, connect a diode in series to the load, as shown in Fig. 4-1 "Connecting load with energy".

Connect a diode that meets the following conditions:

- It must have sufficient reverse voltage resistance against the rated voltage of the unit.
- It must have sufficient forward current capacity against the rated current of the unit.
- Take proper measures for the radiating heat generated by the elements.

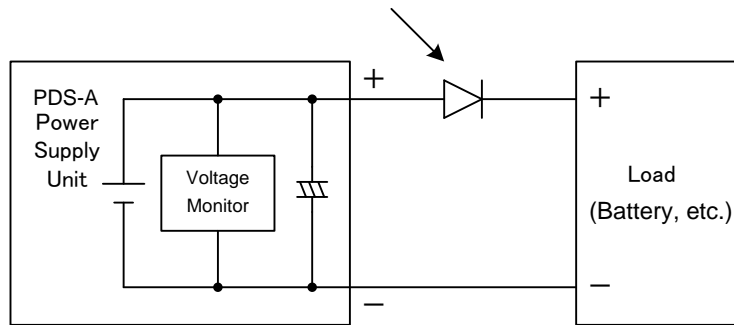

Fig. 4-1 Connecting load with energy

Current capacity of load cable

The cable used as a load cable must have sufficient current capacity against the rated output current of the unit

AWG	Sectional area mm ²	Recommended A
14	2	10
1	38	100
3/0	80	200

(Reference values at an ambient temperature of 30°C.)

4-2. Alarm

The hardware detects abnormal states and displays “AC oFF” or “ALP” on the voltage and current indicators.

Alarm causes

	Cause	Recoverable
1	Over input voltage: Supply voltage of 270VAC or greater	No
2	Under input voltage: Supply voltage of 80VAC or less	No
3	Wrong number of power units used in parallel master-slave operation	No
4	Front output over current: Current from the front output is 30A or greater	Yes
5	Internal overheat: Internal heat sink temperature of approx. 110°C or higher	Yes
6	Over output voltage: 115% of maximum voltage or greater	Yes
7	Over output current: 115% of maximum current or greater	Yes

● Unrecoverable alarm

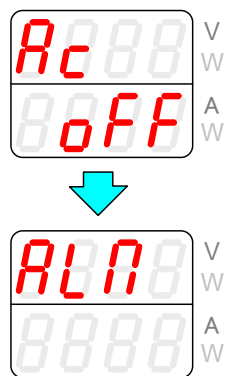

If the voltage and current indicators display “AC oFF” and then “ALP”, and the power switch has not been turned off, there may be a unit malfunction. Perform the following steps:

1. Turn off the power switch.
2. Disconnect the power cable from the AC outlet or distribution panel.
3. Check whether any of the causes described in 1 through 3 have occurred.

● Recoverable alarm

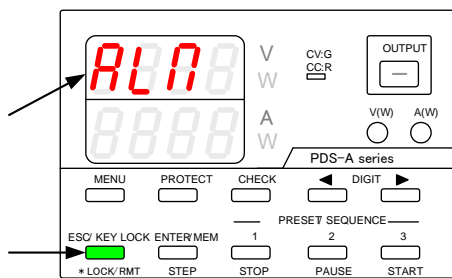

If the voltage indicator displays “ALP”, and the ESC key is lit in green, press the ESC key.

This makes it possible to turn the power of the unit on or off.

Check whether any of the causes described in 4 through 8 have occurred.

If the cause of the alarm was one of the causes described in 6 through 8, the unit may need to be repaired or recalibrated.

5. FUNCTIONS AND OPERATION PROCEDURES

5-1. Operation modes







The unit has four basic operation modes, which are as follows:

Operation Mode	Description
Manual mode	Setting by manual operation on the panel.
Sequence mode	Setting changes over time according to the sequence program stored in the internal memory.
External analog control	Setting via external analog signals and ON/OFF signal.
External digital control	Setting via external communication device.

5-2. Turning On Power

5-2-1. Display when power is turned on

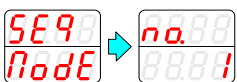
Properly connect the AC power cable of the PDS-A power supply unit, confirm that power is being supplied, and then turn on the power switch. The following characters are displayed on the voltage and current indicators until the unit is ready for normal operation.

	These characters are displayed after the power switch is turned on.
	The rated voltage is displayed in the upper row, and the rated current in the lower row. (The rating is displayed while the internal test is performed.)
	The software version is displayed.
	When using a parallel connection, the version is displayed for 2 seconds. The display then switches to the unit scan window.
	The unit can be operated. Manual mode.
	The unit can be operated. Sequence mode. After displaying the seq mode, step No. is displayed.
	When Main relay is off, These characters are displayed after the power switch is turned on.

5-2-2. Performing a unit scan while using a parallel connection

When a parallel connection is set up, the master unit checks the operation status of the slave units.

The voltage and current indicators display the following messages until the unit enters normal operation status.

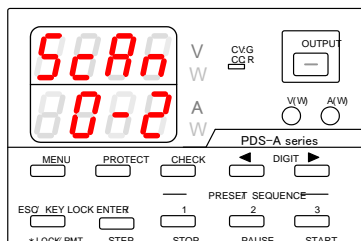

When a scan is performed while a parallel connection is being used, the word "ScAn" is displayed on the voltage indicator. The scanning status is displayed on the current indicator. In the left figure, "0" indicates the number of scanned units, and "2" indicates the number of registered units in the parallel connection.

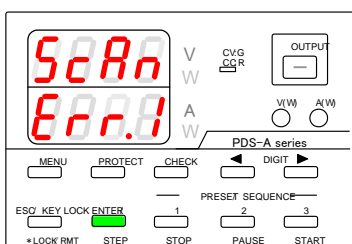

If the unit detects a number other than the number of registered units, an error message is displayed, as shown in the figure on the left.

The final digit of the current indicator indicates the number of units detected, including the master unit.

In the figure on the left figure, the number listed in the error message is "1". This number indicates that the master unit was detected, but no slave units.

If this error message is displayed, check the settings and wiring, and then restart the power supply unit.

5-2-3. Recalling Settings When Turning on Power, and Saving the Setting Data

The PDS-A power supply unit saves setting data in a non-volatile memory when the unit is turned off, or before the power is cut. The settings are recalled when the unit is turned on. The default settings and the settings after initializing the memory for the stored setting items are shown below.

Table 5-1. Stored setting items: Manual mode

Manual mode	Initial setting
Sequence mode	Off
Preset data recalled when power is turned on	Last
Output Off display	Set value
Output On setting when power is turned on	Off
Main relay setting when power is turned on	On
Master-slave	Single-unit operation
CC priority output	Off
Output Off timer	0 min.
Setting cancellation time	3 min.
Set OVP	Maximum
Set UVP	Minimum
Set OCP	Maximum
Set voltage (including stored Preset voltages)	0V
Set current (including stored Preset currents)	0A
System address	1
PC address	1
PC address configured via LAN	0

Table 5-2. Stored setting items: Sequence mode

Sequence mode	Initial setting
Set voltage for each step	0V
Set current for each step	0A
Output for each step	Off
OVP for each step	Maximum
UVP for each step	Minimum
OCP for each step	Maximum
Execution time for each step	00h00m00s000
Pause operation for each step	OFF
Output HI-R setting for each step	OFF
Start step	1
End step	1000
Number of repeating programs	1
Execution mode	0

※ A battery cell is not used to store setting data.

※ When the main relay is off, it is not done writing to the non-volatile memory.

5-3. Basic Operation

5-3-1. Voltage setting procedure

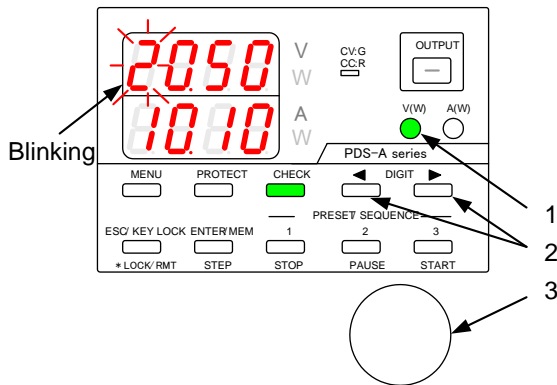

Operation procedure

1. Press the V key, which is then lit in green.
One of the voltage setting digits starts blinking.
Only the digit that is blinking can be modified.
2. Press one of the DIGIT keys ◀ ▶ to move to another digit and make it blink.
3. Use the setting rotary encoder to set the voltage value.
4. Press the V key to exit the setting mode.

5-3-2. Current setting procedure

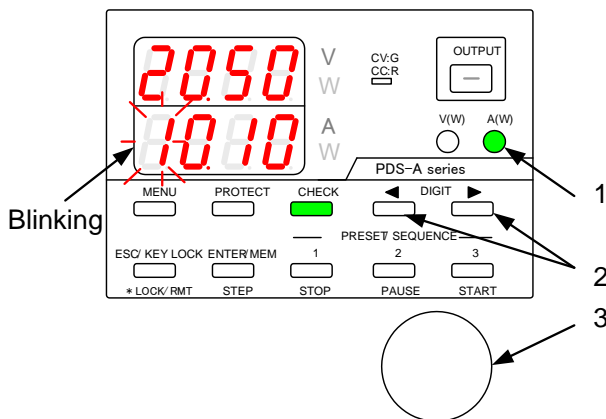

Operation procedure

1. Press the A key, which is then lit in green.
One of the current setting digits starts blinking.
Only the digit that is blinking can be modified.
2. Press one of the DIGIT keys ◀ ▶ to move to another digit and make it blink.
3. Use the setting rotary encoder to set the current value.
4. Press the A key to exit the setting mode.

5-3-3. Fine adjustment of voltage/current

Function: Fine-adjusting the output voltage/current to a digit lower than the displayed digits

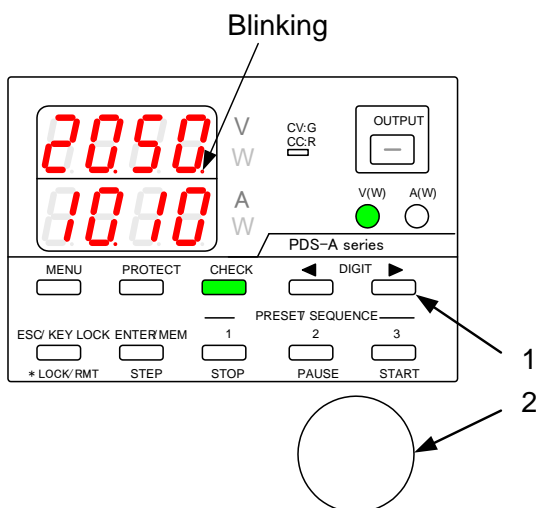

Operation procedure

1. Confirm that the rightmost digit is blinking, and press the DIGIT key ▶ to move the modifiable digit to the right.
The rightmost digit stops blinking and then remains lit.
2. With the rightmost digit lit, turn the setting rotary encoder to adjust the voltage/current to one digit lower than the lowest displayed digit.

The digit lower than the displayed digit is not visible. You must connect an external device to confirm the actual output. Note that the amount of change made by one click of the rotary encoder might differ by model.

The setting accuracy in SPECIFICATIONS is not guaranteed for fine adjustment.

5-4. Output Functions

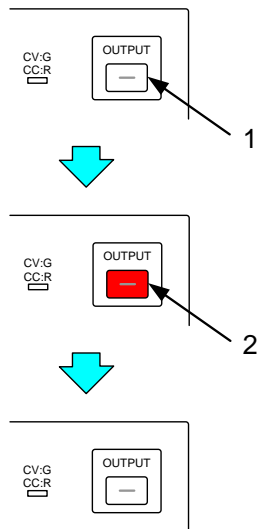

Operation procedure

1. Press the unlit OUTPUT key, which is then lit in red. After this key is lit, voltage is output.
2. Press the red-lit OUTPUT key. The light goes out, and the voltage output is turned off.



CAUTION Make sure the wires are connected to the output terminals before turning the output on.

5-5. Memory Function

5-5-1. Storing and recalling preset voltage/current data

● Storing preset data

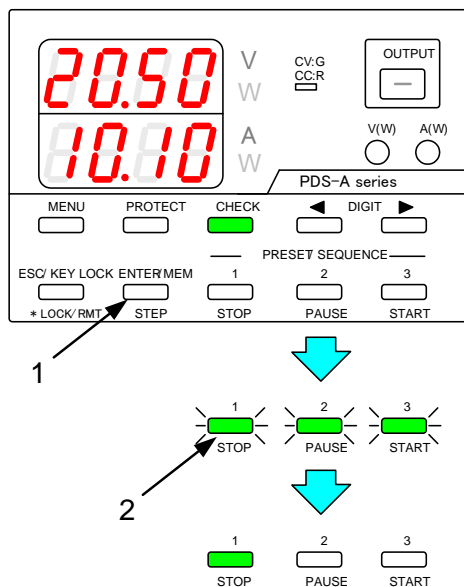

Operation procedure

1. Set the voltage and current values, following the steps described in
 - “5-3-1. Voltage setting procedure”
 - “5-3-2. Current setting procedure”

Press the ENTER/MEM key.

PRESET keys 1 to 3 all blink green.

2. Press the PRESET key (1, 2, or 3) where you want to store the set value.

The PRESET key you pressed lights in green. The voltage and current values are stored in the selected PRESET key.

※ To cancel storing the set values, press the ENTER/MEM key again while PRESET keys 1 to 3 are all blinking green.

● Recalling preset data

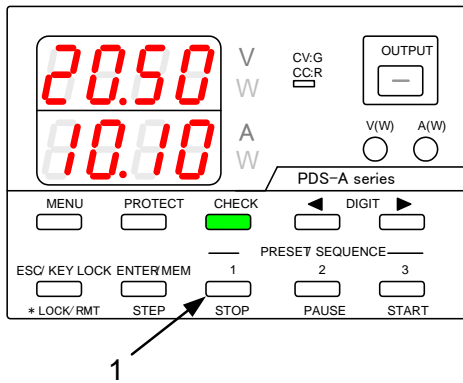

Operation procedure

1. Press a PRESET key (1, 2, or 3) to recall the voltage and current values stored in that key.

5-6. Switching the display in the Voltage/Current Indicator Display.

5-6-1. Switching between the set voltage/current display and output voltage/current display

Operation procedure

When the CHECK key is lit in green, the set voltage and current are displayed.

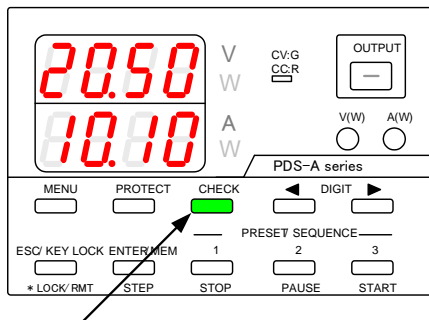

When the CHECK key is unlit, the output voltage and current are displayed.

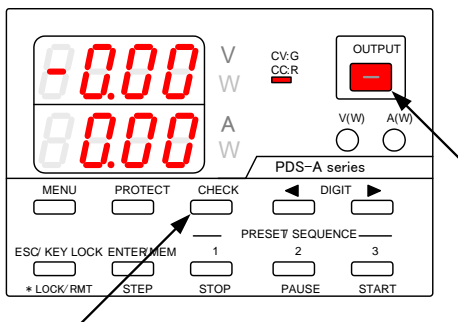

When the output is off, the CHECK key remains lit in green.
(No CHECK key operations can be performed.)

When the OUTPUT key is pressed and then lit in red (turning the output on), the CHECK key light goes out.

5-6-2. Displaying Power in the Voltage and Current Indicators

- Displaying output power in the voltage indicator:

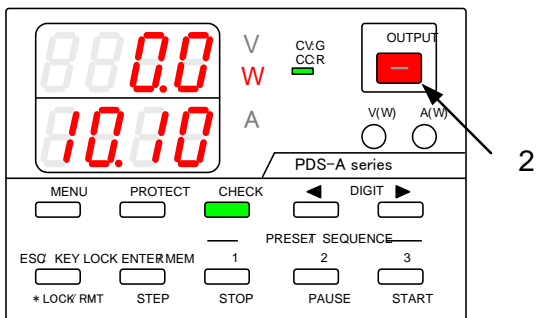
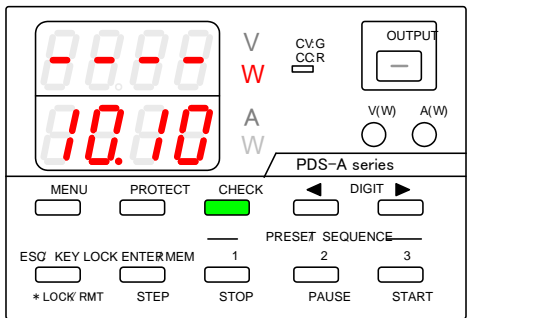
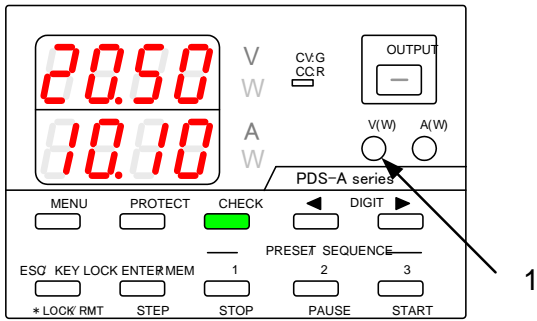

Operation procedure

1. When voltage is displayed, press and hold the V key to display the output power.

When the output is off, the output power is displayed as “----”.

Press and hold the unlit V key to display the voltage again.

2. Press the OUTPUT key to display the output power.

●Displaying output power in the current indicator:

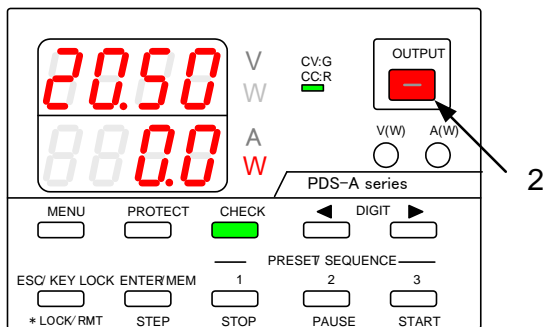
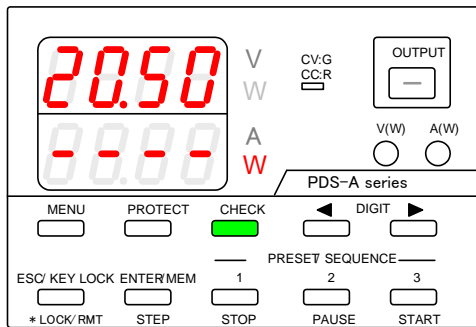
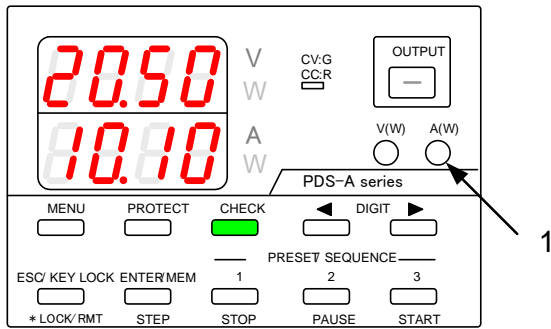

Operation procedure

1. When current is displayed, press and hold the A key to display the output power.

When the output is off, the output power is displayed as “-----”.

Press and hold the unit A key to display the current again.

2. Press the OUTPUT key to display the output power.

When the V and A keys are lit, the display cannot be switched to the output power display.

5-7. Protective Functions

The PDS-A power supply unit has 3 different protective functions (OVP, UVP, and OCP). Set the value for each of the protective functions to fit the intended use of the unit.

Function	Description
OVP	Turns the output off when the output voltage exceeds the set voltage for OVP.
UVP	Turns the output off when the output voltage falls below the set voltage for UVP.
OCP	Turns the output off when the output current exceeds the set current for OCP.
For the UVP and OCP functions, the software detects output voltage and current and turns the output off if needed.	

5-7-1. Display when protective functions are activated

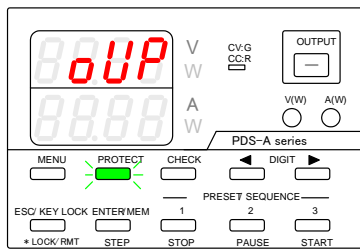

OVP (Overvoltage protection)

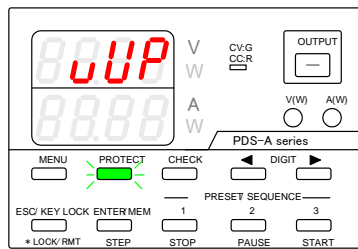

UVP (Undervoltage protection)

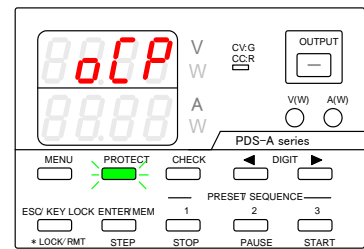

OCP (Overcurrent protection)

5-7-2. Modification of the Set Values of Protective Functions

When modifying the set value of a protective function, press the PROTECT key and select the protective function to be modified. Modify the set values by using the DIGIT keys ◀ ▶ and the rotary encoder.

Operation procedure

1. Press the PROTECT key, which is then lit in green. The protective function type is displayed in the current indicator, and the modifiable digit blinks in the voltage indicator.
2. Press the DIGIT keys ◀ ▶ to select the digit to be modified. Only the digit that is blinking can be modified.
3. Use the rotary encoder to modify the set value.
4. After setting the protective function, press the blinking ESC/KEY LOCK key to store the set value of the protective function.

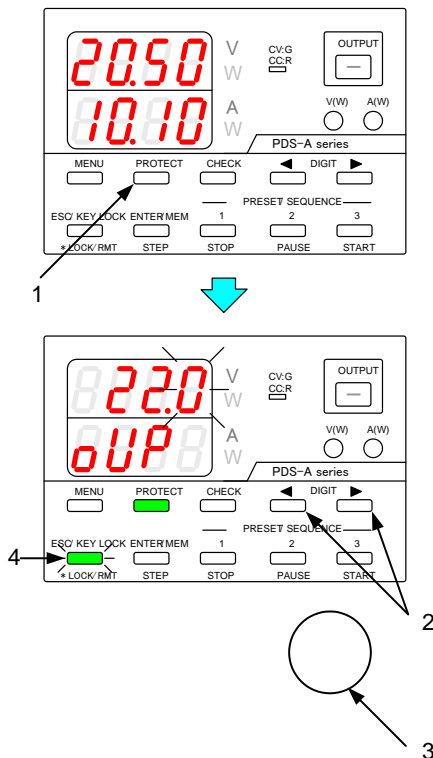

5-7-3. Deactivating Protective Functions

When some protective functions are activated, it is displayed and the output is turned off.

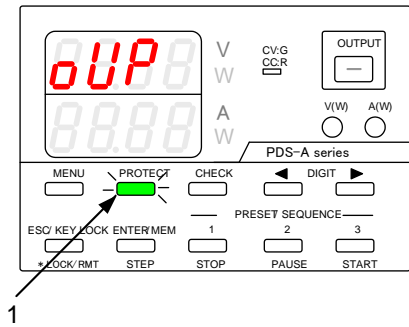

Operation procedure

1. When the activated protection is displayed, press the PROTECT key, which is blinking green, to deactivate the protective function.

After deactivating the protective function, the unit can be operated while output is off.

5-8. Key Lock / Local Function

Status	Non-operational keys
KEY LOCK	All keys, excluding the ESC/KEY LOCK key, OUTPUT key (only when turning the output off), and the rotary encoder.
REMOTE	All keys, excluding the ESC/KEY LOCK key and rotary encoder.

5-8-1. Key lock and unlock procedures

● Key lock procedure

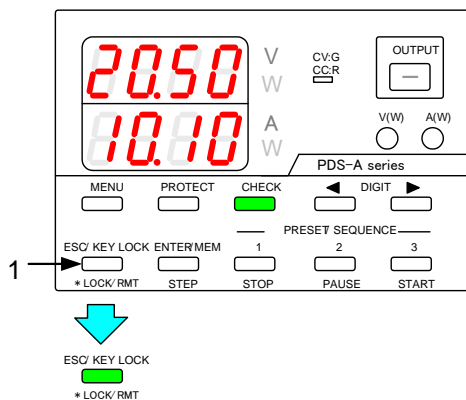

Operation procedure

1. When the MENU key and the PROTECT key are unlit, press and hold the ESC/KEY LOCK key, which is then lit in green.

This activates key lock. After key lock is activated, you cannot operate the keys and the rotary encoder.

● Key unlock procedure

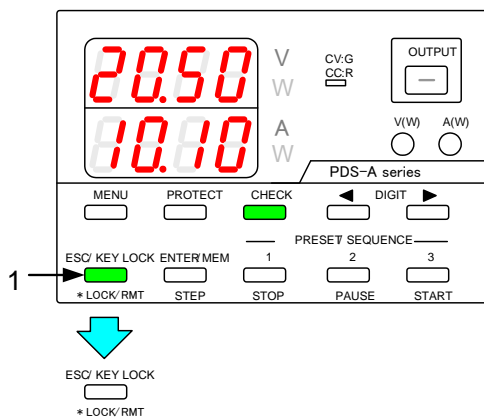

Operation procedure

2. Press and hold the green-lit ESC/KEY LOCK key. The light then goes out.

This deactivates key lock. After key lock is deactivated, you can operate the keys and the rotary encoder.

While key lock is activated, the output can be turned off. However, if the output is already off, it cannot be turned on.

5-8-2. Remote mode deactivation procedure

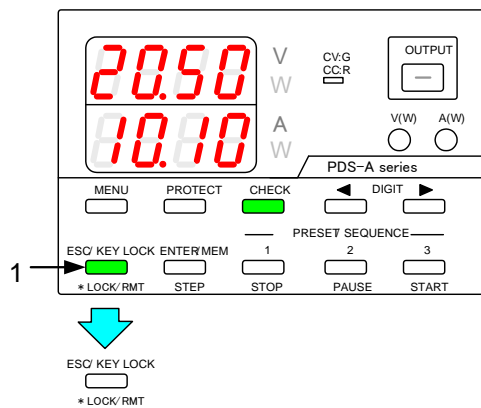

Operation procedure

When the unit is operated via external digital control, the ESC/KEY LOCK key is lit in green and the unit is remotely controlled.

When the unit is remotely controlled, you cannot operate the keys and the rotary encoder.

1. Press and hold the green-lit ESC/KEY LOCK key. The light then goes out.

This returns the unit to local mode. You can operate the keys and the rotary encoder after the unit returns to local mode.

Even if the unit is in local mode, it returns to remote mode when it is operated via external digital control.

6. SETTING WITH THE MENU KEY

● The following items can be set by using the MENU key:

Setting item	Explanation in the manual	Page
Setting the output off timer	6-1-1. Setting the output off timer	28
Specifying the automatic cancellation time of the setting menu display	6-2. Specifying the automatic cancellation time of the setting menu display	30
Confirming that output is off	9-2-6. Checking the status when the output is off	75
Confirming the interface card mode	11-1-4. Confirming the interface card mode	80

Push the MENU key to change the display. Items with no assigned functions are skipped.

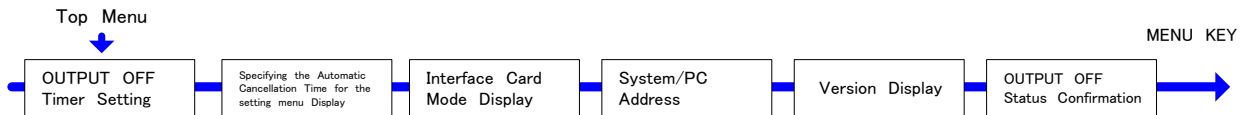

● The following items can be set when turning on the power switch while pressing and holding the MENU key:

Setting item	Explanation in the manual	Page
Recalling preset values when the power is turned on	6-3-1. Recalling preset values when the power is turned on	31
Setting the output when the power is turned on	6-3-2. Setting the output when the power is turned on	32
Setting the CC priority mode	6-3-3. Setting the CC priority mode	33
Setting the display while the output is off	6-3-4. Setting the display while the output is off	36
Configuring the master and slave units	7-1-1. Configuring the master and slave units	44
Setting sequence operation	8-1. Setting of Sequence Operation	50
Address settings	11-1-5. Address settings	81
RS-232C communication speed setting (while IF-71RS is in full-duplex mode)	6-3-6. Specifying the baud rate while in IF-71RS PDS mode	40
Specifying power relay ON/OFF (with remote IF)	6-3-5. Default setting of the power relay when power is turned on	39

Push the MENU key to change the display. Items with no assigned functions are skipped.

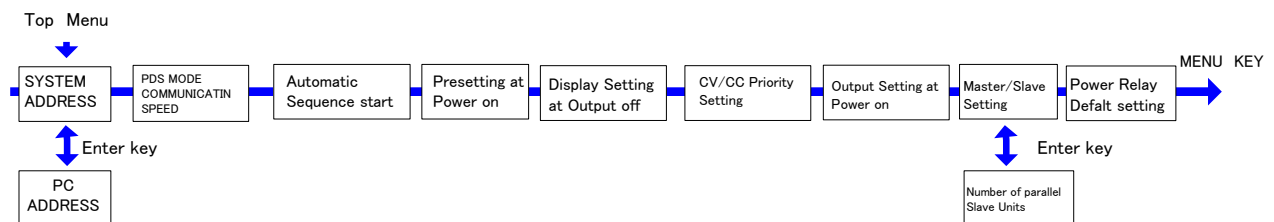

● The following items can be set when turning on the power switch while pressing and holding the ENTER/MEM key:

Setting item	Explanation in the manual	page
Memory clear	6-4. Clearing the Memory	39

6-1. Output Off Timer

This function is used to automatically turn off the output after a preset amount of time has passed since the output was turned on.

6-1-1. Setting the output off timer

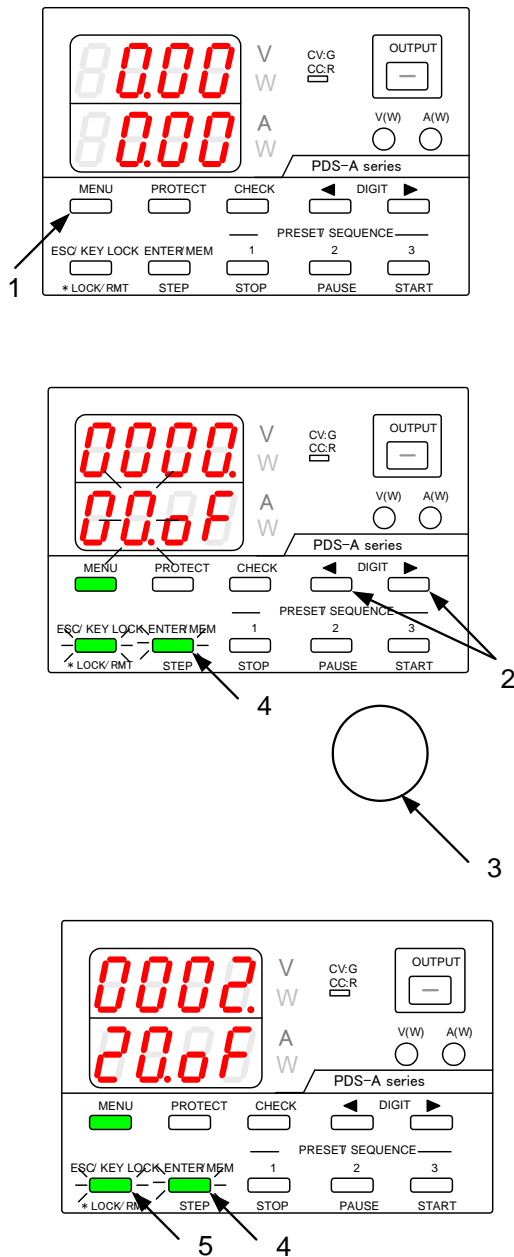

Operation procedure

1. Turn the output off, then repeatedly press the MENU key until the current indicator displays “ * .oF” .

The MENU key is then lit in green, and the ESC/KEY LOCK key and the ENTER/MEM key start blinking green.

2. Press the DIGIT keys ◀ ▶ to select the digit to be modified. Only the digit that is blinking can be modified.

Press the DIGIT keys ◀ ▶ a few times to move the blinking digit from the voltage indicator to the current indicator.

3. Use the rotary encoder to specify the desired setting.

The hours are set in the voltage indicator, and the minute are defined in the current indicator. In the left figure, the output off timer is set for 2 hrs. and 20 min.

The timer range is from 1 min. to 1000 hrs. and 59 min, and can be adjusted in 1 min. increments. Specifying 0 min. for the timer deactivates the output off timer function.

4. Press the green-blinking ENTER/MEM key to enter the setting.

After the setting is entered, the current indicator stops blinking, remains lit for a short while, and then starts blinking again.

5. Press the green-blinking ESC/KEY LOCK key to exit.

Normal operation of the unit is then available.

This setting must be specified while the output is off.

6-1-2. Operating the output off timer

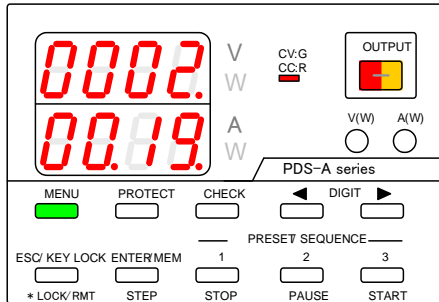
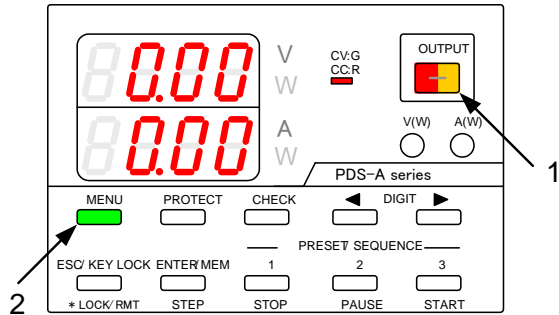

Operation procedure

1. Press the OUTPUT key to turn the output on.

The CV/CC LED is lit in green when the output on status is CV, and red when it is CC.

If the output off timer has been set for a certain amount of time, the OUTPUT key is alternately lit in red and amber.

2. Press the MENU key, which is then lit in green. This starts the countdown for the set time specified in ["6-1-1. Setting the output off timer"](#).

After the set time has passed, the OUTPUT key light goes out, and the output is turned off.

6-2. Specifying the automatic cancellation time of the setting menu display

Specifies the time to cancel the setting automatically after the PDS-A unit has been left alone for a certain amount of time in each setting menu (voltage, current, OVP, UVP, and OCP).

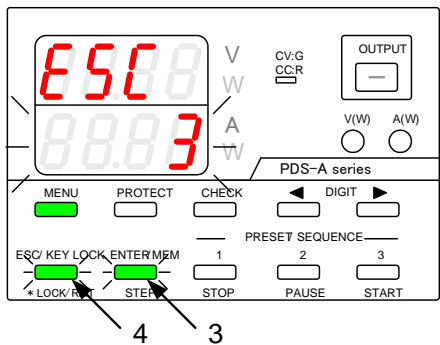
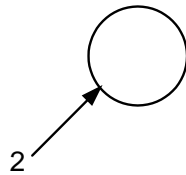
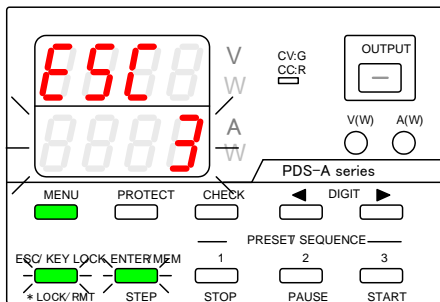
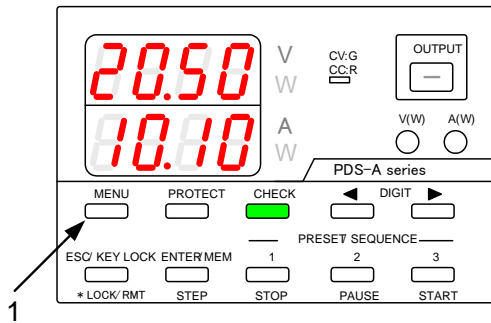

Operation procedure

1. Turn the output off, then repeatedly press the MENU key until "ESC" is displayed in the voltage indicator.

The MENU key is then lit in green, and the ESC/KEY LOCK key and the ENTER/MEM key start blinking green.

The function name is displayed in the voltage indicator, and the function setting is displayed (blinking) in the current indicator.

2. Turn the rotary encoder to set the display time, which is displayed in the current indicator.

The display time range is from 0 min. to 10 min., and can be adjusted in 1 min. increments. (If 0 min. is set for the display time, the setting display is not disabled automatically.)

3. Press the green-blinking ENTER/MEM key to enter the setting.

After the setting is entered, the current indicator stops blinking, remains lit for a short while, and then starts blinking again.

4. Press the green-blinking ESC/KEY LOCK key to exit. Normal operation of the unit is then available.

6-3. Specifying Settings when the Power Is Turned On

6-3-1. Recalling preset values when the power is turned on

The voltage and current values can be set when the power is turned on.

The voltage and current values that can be selected are the set values from when power was last turned off, and the data stored in PRESET keys 1, 2, and 3.

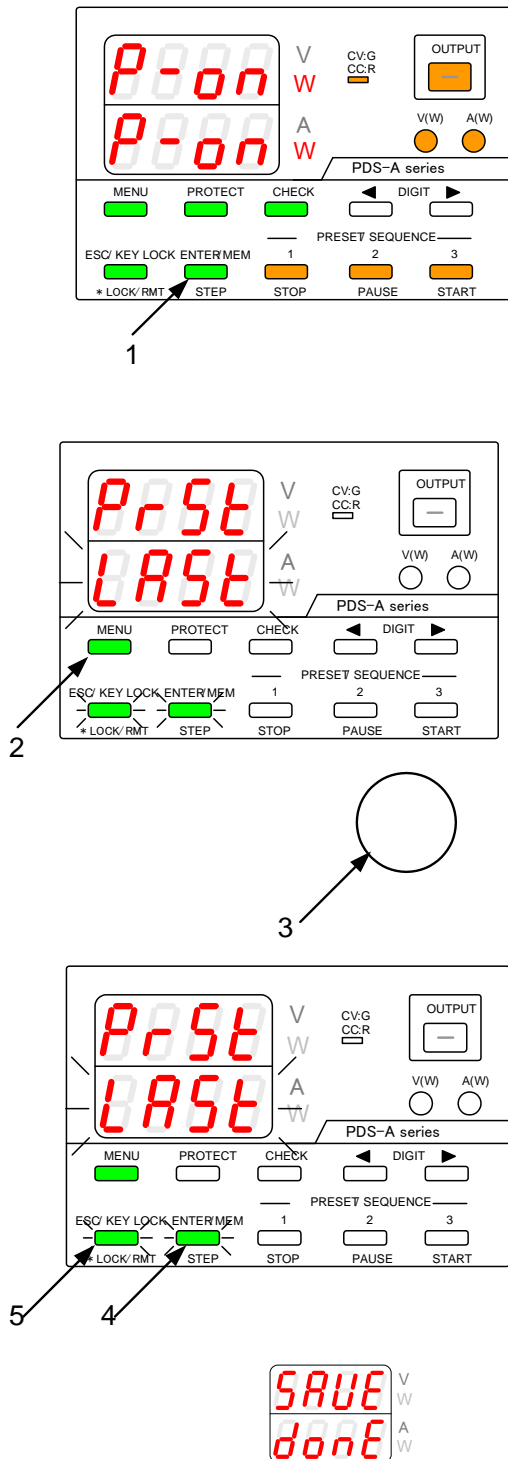

Operation procedure

1. Turn on the power switch while pressing and holding the MENU key.

Release the MENU key when the panel is lit.

The MENU key is then lit in green, and the ESC/KEY LOCK key and the ENTER/MEM key start blinking green.

The function name is displayed in the voltage indicator, and the function setting is displayed (blinking) in the current indicator.

2. Repeatedly press the MENU key until "PrSt" is displayed in the current indicator.
3. Turning the rotary encoder displays the following. Select the values you want to recall.

LAST ^A _W The set values from when the power last turned off.

Pr-1 ^A _W The values stored in the PRESET 1 key.

Pr-2 ^A _W The values stored in the PRESET 2 key.

Pr-3 ^A _W The values stored in the PRESET 3 key.

4. Press the green-blinking ENTER/MEM key to enter the setting.

After the setting is entered, the current indicator stops blinking, remains lit for a short while, and then starts blinking again.

5. Press the green-blinking ESC/KEY LOCK key to exit. The message shown in the figure on the left appears. Normal operation of the unit is then available.

Turn the power switch off and then back on to reflect the selected PRESET values.

6-3-2. Setting the output when the power is turned on

When the power is turned on, the PDS-A power supply unit can turn the output on, without needing to push the OUTPUT key.

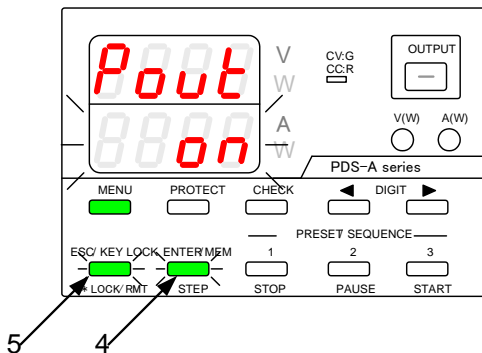
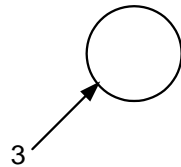
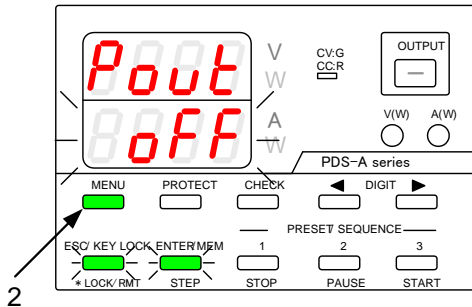
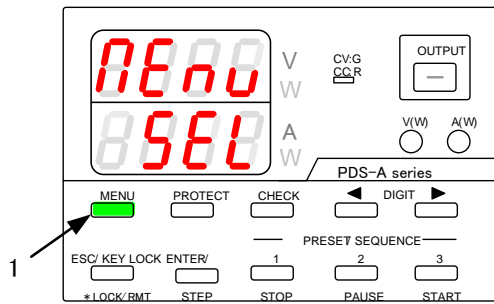

Operation procedure

1. Turn on the power switch while pressing and holding the MENU key.

Release the MENU KEY when the panel is lit.

The MENU key is then lit in green, and the ESC/KEY LOCK key and the ENTER/MEM key start blinking green.

The function name is displayed in the voltage indicator, and the function setting is displayed (blinking) in the current indicator.

2. Repeatedly press the MENU key until "Pout" is displayed in the voltage indicator.
3. Turning the rotary encoder displays the following in the current indicator. Select the desired setting.



4. Press the green-blinking ENTER/MEM key to enter the setting.

After the setting is entered, the current indicator stops blinking, remains lit for a short while, and then starts blinking again.

5. Press the green-blinking ESC/KEY LOCK key to exit. The message shown in the figure on the left appears. Normal operation of the unit is then available.

Turn the power switch off and then back on to display the entered voltage and current.



By specifying the above setting, the unit will start with the output on when the power is turned on. However, this may destroy loads if the wrong voltage or current have been set.

Be sure to confirm the set voltage and current values before turning the power off. If a standard board or IF-70PS has been installed, this setting can only be performed when the external output is on.

6-3-3. Setting the CC priority mode

Operation procedure

1. Turn on the power switch while pressing and holding the MENU key.

Release the MENU key when the panel is lit.

The MENU key is then lit in green, and the ESC/KEY LOCK key and the ENTER/MEM key start blinking green.

The function name is displayed in the voltage indicator, and the function setting is displayed (blinking) in the current indicator.

2. Repeatedly press the MENU key until "cc-P" is displayed in the current indicator.

3. Turning the rotary encoder displays the following in the current indicator. Select the desired setting.

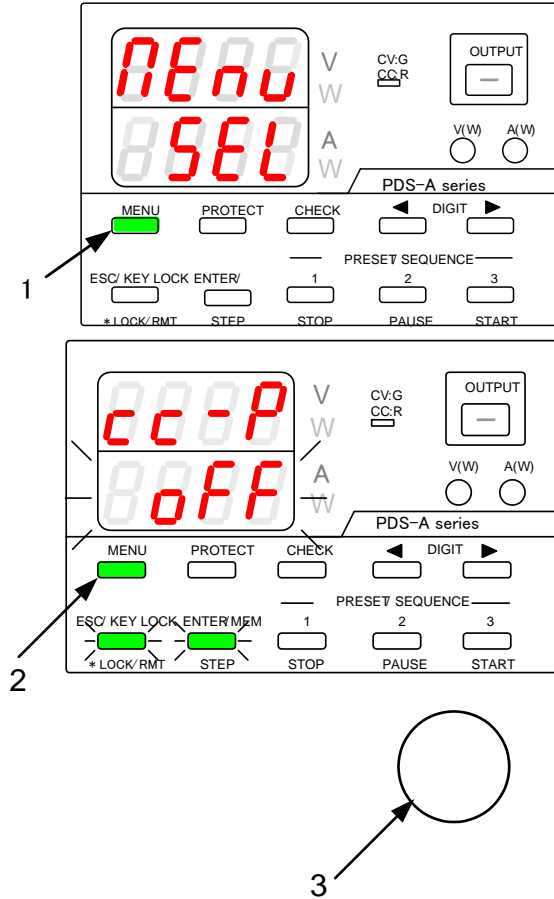

CC priority mode off

(When the unit is operated with a load in CV mode while the output is on.)



CC priority mode on

(When the unit is operated with a load in CC mode while the output is on.)



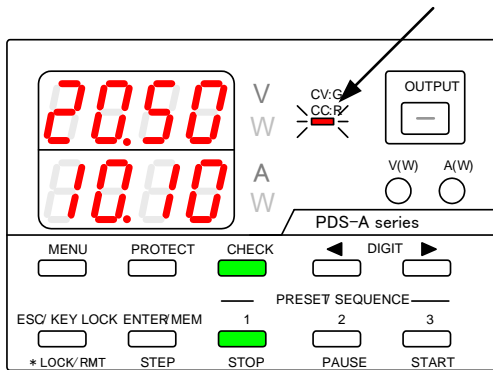
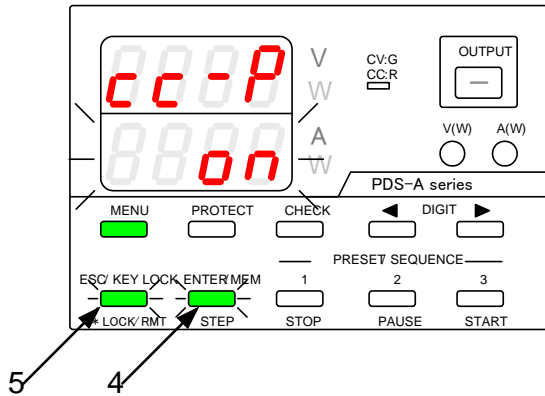

Operation procedure

4. Press the green-blinking ENTER/MEM KEY to enter the setting.

After the setting is entered, the current indicator stops blinking, remains lit for a short while, and then starts blinking again.

5. Press the green-blinking ESC/KEY LOCK key to exit. The message shown in the figure on the left appears. Normal operation of the unit is then available.

Turn the power switch off and then back on to display the voltage and current that were entered.

If CC priority mode is off, the CV/CC LED remains unlit while the output is off.

If CC priority mode is on, the CV/CC LED blinks red while the output is off.

Turning the output on when CC priority mode is selected

If it is determined beforehand that the loads connected to the unit are controlled in CV mode or CC mode, the voltage/current overshoot generated while output is on can be eliminated by using CC priority mode.

The following are the output voltage and current waveforms, according to the status of CC priority mode, while the output is on.

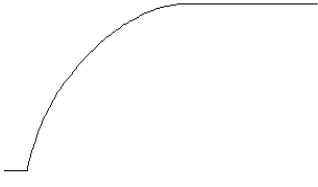
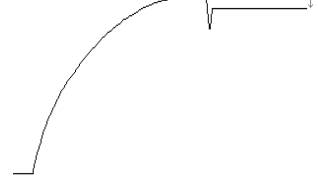
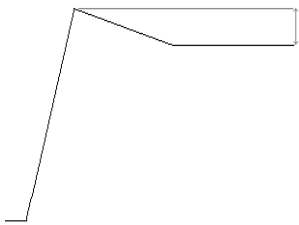
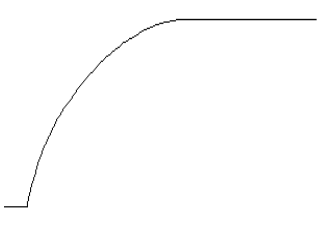
CC mode priority function	Output voltage waveform for when a load causes the unit to operate in CV mode	Output current waveform for when a load causes the unit to operate in CC mode
OFF	 <p data-bbox="592 808 986 869">Almost no overshoot in the output voltage.</p>	 <p data-bbox="1010 808 1404 902">An overshoot of approx. 10% of the rated current is generated in the output current.</p>
ON	 <p data-bbox="592 1227 986 1288">An overshoot may be generated in the output voltage.</p>	 <p data-bbox="1010 1227 1404 1288">Almost no overshoot in the output current.</p>

The above voltage and current waveforms assume that the resistance is the load of this unit. If other loads are used for resistance, the voltage and current waveforms may differ from those shown above.

6-3-4. Setting the display while the output is off

The voltage and current indicators can display either the set values or output values while the output is off.

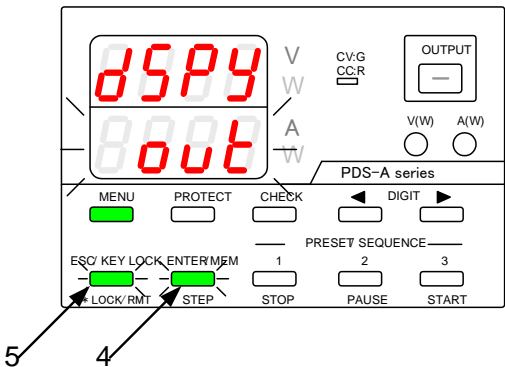
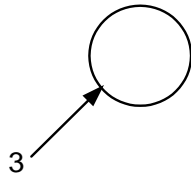
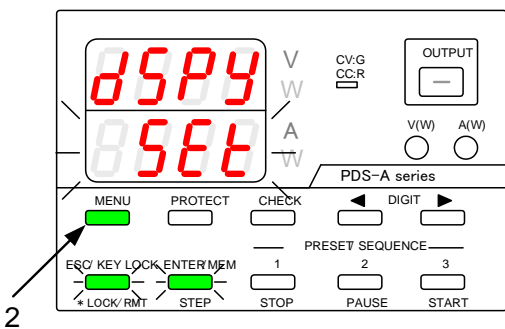
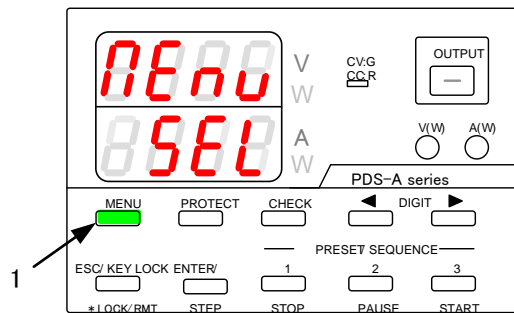

Operation procedure

1. Turn on the power switch while pressing and holding the MENU key.

Release the MENU key when the panel is lit.

The MENU key is then lit in green, and the ESC/KEY LOCK key and the ENTER/MEM key start blinking green.

The function name is displayed in the voltage indicator, and the function setting is displayed (blinking) in the current indicator.

2. Repeatedly press the MENU key until "dSPY" is displayed in the voltage indicator.
3. Turning the rotary encoder displays the following in the current indicator. Select the desired setting.



4. Press the green-blinking ENTER/MEM KEY to enter the setting.

After the setting is entered, the current indicator stops blinking, remains lit for a short while, and then starts blinking again.

5. Press the green-blinking ESC/KEY LOCK key to exit. The message shown in the figure on the left appears. Normal operation of the unit is then available.

Turn the power switch off and then back on again to display the selected values

This setting is invalid when the output HI-R function is on.

When output is off, the voltage indicator displays the output voltage, and the current indicator blinks and displays "Hi-r".

6-3-5. Default setting of the power relay when the power is turned on

If the remote control card (IF-70GU, IF-71RS or IF-71LU) is installed, the default status (on/off) of the main power relay can be specified when the power is turned on.

Operation procedure

1. Turn on the power switch while pressing and holding the MENU key.

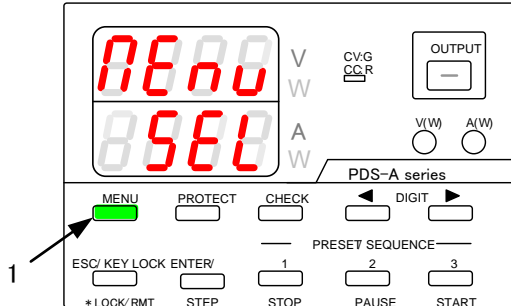

Release the MENU key when the panel is lit.

The MENU key is then lit in green, and the ESC/KEY LOCK key and the ENTER/MEM key start blinking green.

The function name is displayed in the voltage indicator, and the function setting is displayed in the current indicator.

2. Repeatedly press the MENU key until "PonP" is displayed in the voltage indicator.
3. Turning the rotary encoder displays the following in the current indicator. Select the desired setting.

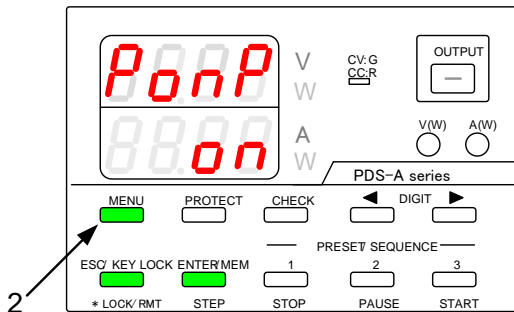

Displays set values.

Displays output values.

4. Press the green-blinking ENTER/MEM key to enter the setting.

After the setting is entered, the current indicator stops blinking, remains lit for a short while, and then starts blinking again.

5. Press the green-blinking ESC/KEY LOCK key to exit. The message shown in the figure on the left appears. Normal operation of the unit is then available.

Turn the power switch off and then back on to display the settings that were entered.

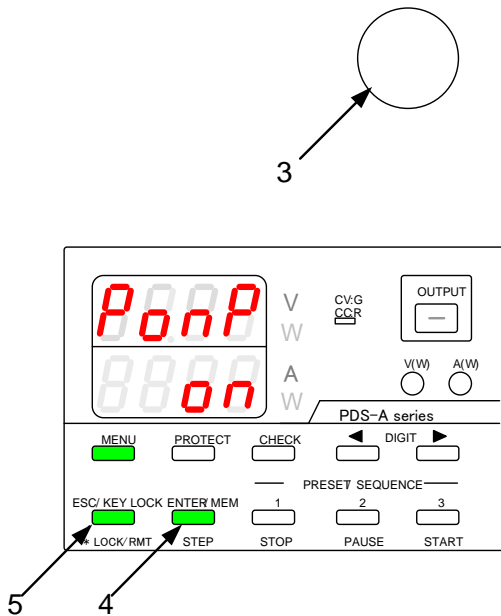

6-3-6. Specifying the baud rate while in IF-71RS PDS mode

If the IF-71RS card was configured while in PDS communication mode, the baud rate can be specified. There is a total of five available rates that can be specified.

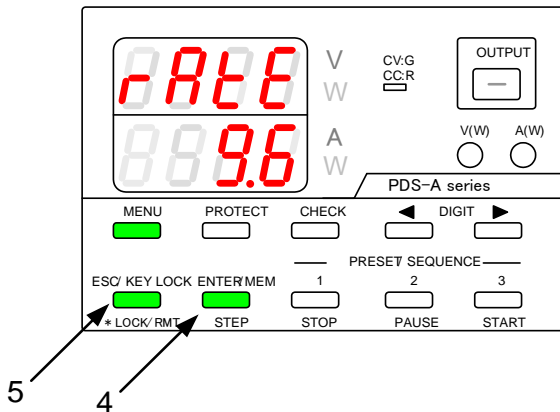
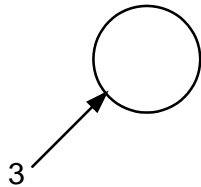
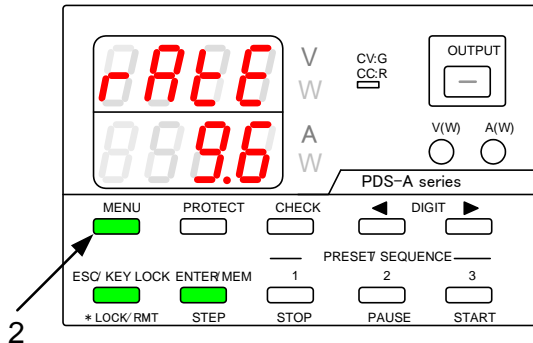
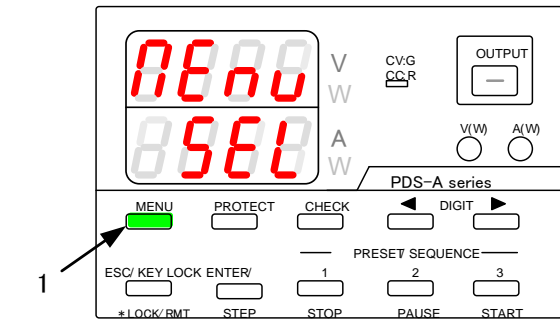

Operation procedure

1. Turn on power switch while pressing and holding the MENU key.

Release the MENU key when the panel is lit.

The MENU key is then lit green, and the ESC/KEY LOCK key and the ENTER/MEM key start blinking green.

The function name is displayed in the voltage indicator, and the function setting is displayed in the current indicator.

2. Repeatedly press the MENU key until "rAtE" is displayed in the voltage indicator.
3. Turning the rotary encoder displays the following in the current indicator. Select the desired setting.

"r 1.2" "r 2.4" "r 4.8"

"r 9.6" "r 19.2"

4. Press the green-blinking ENTER/MEM key to enter the setting.

After the setting is entered, the current indicator stops blinking, remains lit for a short while, and then starts blinking again.

5. Press the green-blinking ESC/KEY LOCK key to exit. The message shown in the figure on the left appears. Normal operation of the unit is then available.

Turn the power switch off and then back on to display the entered settings.

6-4. Clearing the Memory

There are 3 different ways to clear the data memory:

- (1) Clearing all the setting data stored in the unit, returning the settings to their factory defaults (factory reset).
- (2) Clearing the setting data for manual operation.
- (3) Clearing the setting data for sequence operation.
- (4) Clearing the setting data for IF-71LU IP address setting

6-4-1. Clearing all the setting data stored in the unit

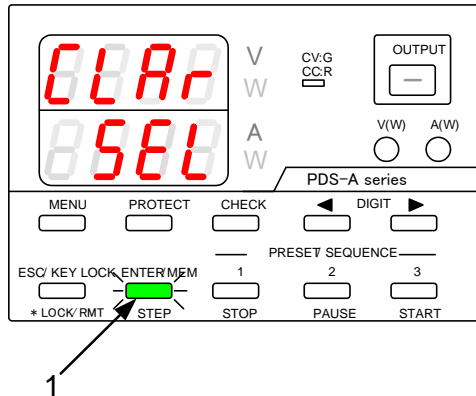

Operation procedure

1. Turn on the power switch while pressing and holding the ENTER/MEM key.

Release the ENTER/MEM key when the panel is lit.

The ESC/KEY LOCK key and the ENTER/MEM key then start blinking green.

The type of memory to be cleared is displayed.

2. Press the ENTER/MEM key.

Pressing the ENTER/MEM key clears the memory.

Pressing the ESC/KEY LOCK key cancels the memory clear.

The message shown in the figure on the left is displayed. The unit is then restarted automatically.

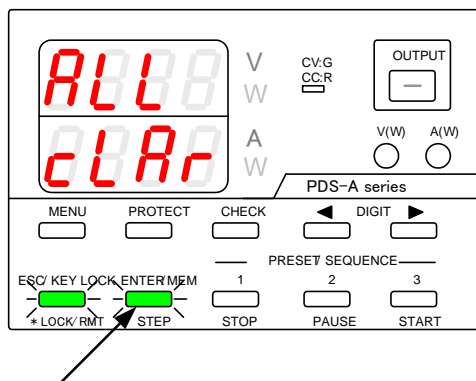

When executed



When canceled

6-4-2. Clearing the setting data for manual operation

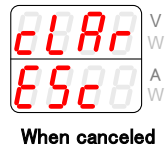
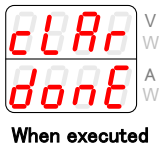
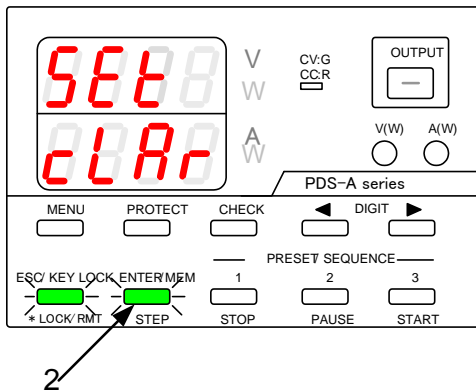
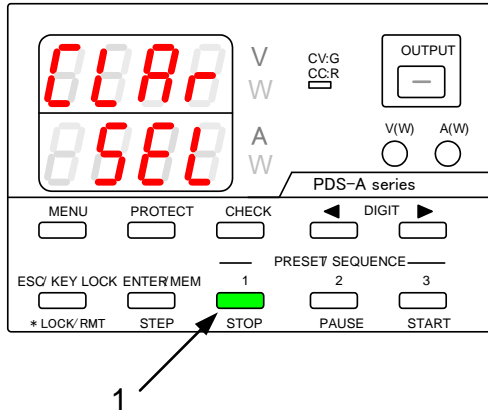

Operation procedure

1. Turn on the power switch while pressing and holding the PRESET 1 key.

Release the PRESET 1 key when the panel is lit.

The ESC/KEY LOCK key and the ENTER/MEM key then start blinking green.

The type of memory to be cleared is displayed.

2. Press the ENTER/MEM key.

Pressing the ENTER/MEM key clears the memory.

Pressing the ESC/KEY LOCK key cancels the memory clear.

The message shown in the figure on the left is displayed. The unit is then restarted automatically.

6-4-3. Clear the setting data of sequence operation

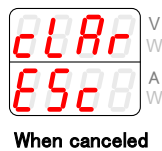
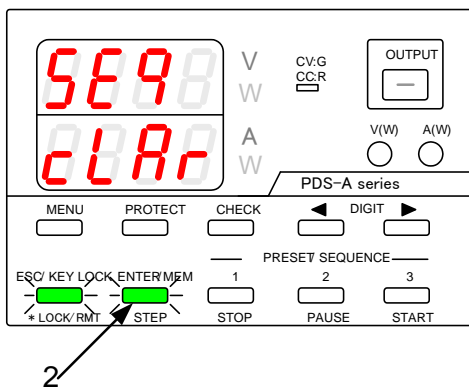
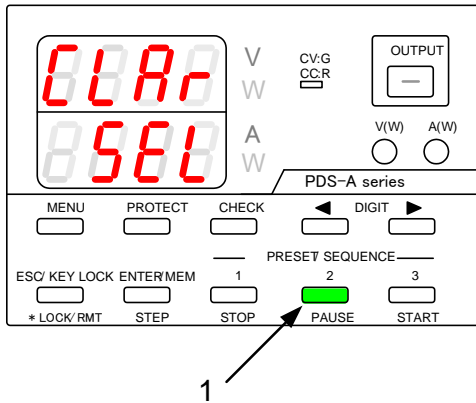

Operation procedure

1. Turn on the power switch while pressing and holding the PRESET 2 key.

Release the PRESET 2 key when the panel is lit.

The ESC/KEY LOCK key and the ENTER/MEM key then start blinking green.

The type of memory to be cleared is displayed.

2. Press the ENTER/MEM key.

Pressing the ENTER/MEM key clears the memory.

Pressing the ESC/KEY LOCK key cancels the memory clear.

The message shown in the figure on the left is displayed. The unit is then restarted automatically.

6-4-4. Clearing the setting data for IF-71LU IP address setting

The configured values, such as the IP address, are saved in the IF-71LU. Even if the PDS-A unit is initialized, the LAN configuration is not reset.

To initialize the LAN for the IF-71LU, perform the following procedure while the IF-71LU is in LAN mode.

During initialization, you can select and configure an automatic IP address or fixed IP address.

For details about configuring an automatic IP address or COM redirector, see the corresponding section in the operation manual. You can download the operation manual from our company's website.

Step-1)

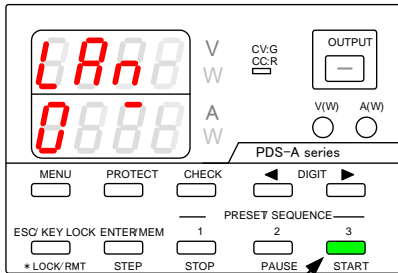

1-1

Step-2)

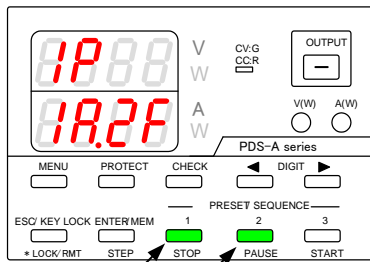

2-1

2-2

Step-3)

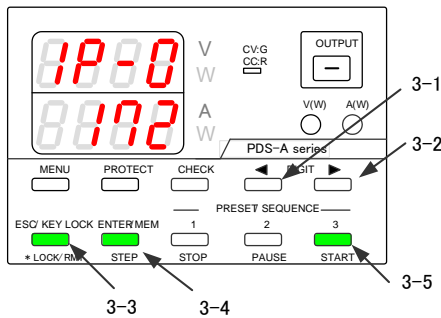

3-3

3-4

3-1

3-2

3-5



(3-4) ENTER key

Operation procedure

- 1-1. Turn on the power switch while pressing and holding the PRESET 3 key.

The window shown in the figure on the left appears, and then a request is issued to initialize the XPort of the card. (The window in the figure on the left is only displayed while in LAN mode.)

If initialization is successful, the number "0" is displayed in the leftmost digit of the current indicator, followed by the number "1" and then "2".

The window shown in the figure on the left is used to select an automatic IP address or fixed IP address.

"1:Auto" (automatic) is displayed in the current indicator, followed by "2:Fix" (fixed). Press the blinking key of the type of address you want to configure.

- 2-1 Press the PRESET 1 key to configure an automatic IP address. Go to Step-4.

- 2-2 Press the PRESET 2 key to configure a fixed IP address. Go to Step-3.

The figure on the left shows the window used to configure a fixed IP address.

There are five selection items displayed in the voltage indicator: "IP-0" to "IP-3" (four items), and "Sub" (subnet mask, one item). Use the corresponding keys to specify the fixed IP address.

- 3-1 Press the ← key to move the cursor to the tens place.
- 3-2 Press the → key to move the cursor to the ones place.
- 3-3 Press the ESC key to return to the value that was saved prior to editing.
- 3-4 Press the ENTER key to save the value and go to the next item.
The IP address in the figure on the left is as follows: 192.168.1.101
(default value when switching from an automatic IP address to a fixed IP address.)
- 3-5 Press the PRESET 3 key to exit the IP settings window.

Binary Rotation

Dot decimal notation					Sub setting values
Subnet mask	High order digits	Second digits	Third digits	Low order digits	
255. 0. 0. 0	1111 1111	0000 0000	0000 0000	0000 0000	24
255. 255. 0. 0	1111 1111	1111 1111	0000 0000	0000 0000	16
255. 255. 255. 0	1111 1111	1111 1111	1111 1111	0000 0000	8
255. 255. 255. 240	1111 1111	1111 1111	1111 1111	1111 0000	4

Sub-setting values represent the number of consecutive zeros in the lower bits of IP-3



For the subnet mask, specify a number from 0 to 32 when "Sub" is displayed in the voltage indicator.

In the figure on the left, "Sub" indicates "16", for which the set value is "255.255.0.0".

For details about other set values for the subnet mask, see the table in the figure on the left.

Step-4)

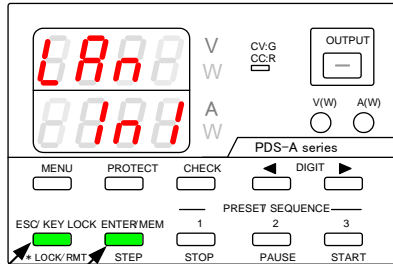

4-1

4-2

After you finish configuring the IP address, the left window appears, asking whether you want to perform initialization.

4-1 Press the ESC key to cancel initialization. The power cycling message is displayed.

4-2 Press the MEMORY key to perform initialization.

Step-5)

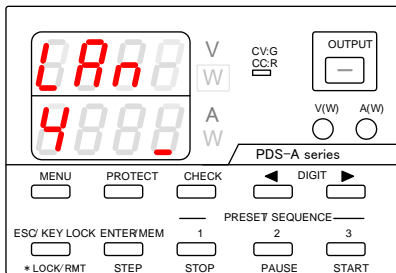

Step-6)

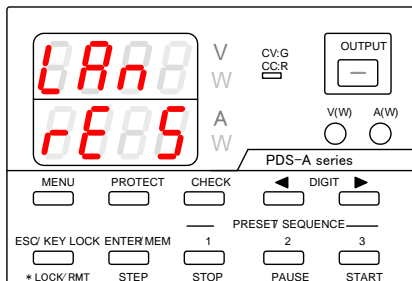

The initialization process consists of the following steps: (3) full initialization of Xport, (4) IP address initialization, (5) IO default settings, (6) save initialization data. The steps are displayed in order of execution in the current indicator display: "3", "4", "5", and then "6".

When initialization is complete, a message which instructs the user to perform power cycling is displayed.

"rE StArt"

Please reboot the PDS-A.

※Error message displayed during initialization



Note:

If the initialization request fails, the message "Cont Err" is displayed, as shown in the left.

If the attempt to perform initialization is unsuccessful, the number (No.) of the step at which initialization failed is displayed together with the word "Err". In the figure on the left, initialization failed during step (4), when all the settings were being initialized.

When selecting automatic IP address setting, PDS-A can not check the assigned IP address. Please check the IP address from the PC using CPR Manager distributed from Lantronix.

7. MASTER-SLAVE OPERATION

The PDS-A power supply unit can be used for parallel master-slave operation and serial master-slave operation.

7-1. Configuration of Master and Slave Units

When used for parallel master-slave operation and serial master-slave operation, the unit must be configured to operate as a stand alone unit, serial master unit, serial slave unit, parallel master unit, or parallel slave unit.

7-1-1. Configuring the master and slave units

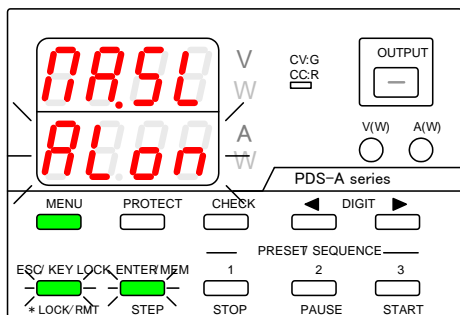
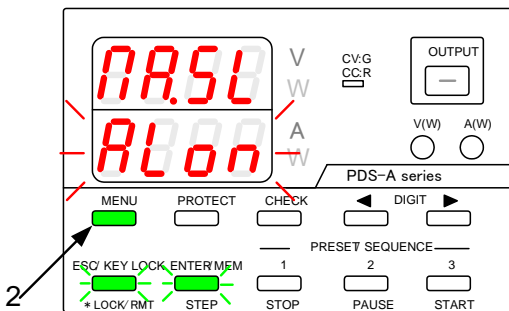
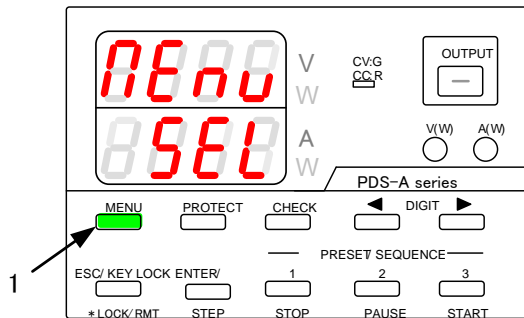

Operation procedure

1. Turn on the power switch while pressing and holding the MENU key.

Release the MENU key when the panel is lit.

The MENU key is then lit in green, and the ESC/KEY LOCK key and the ENTER/MEM key start blinking green.

The function name is displayed in the voltage indicator, and the function setting is displayed (blinking) in the current indicator.

2. Repeatedly press the MENU key until "ΠA.SL" is displayed in the voltage indicator.
3. Turn the rotary encoder to change the setting displayed in the current indicator.

AL00 ^A_W

Stand alone:

Not used for serial or parallel master-slave operation.

S-NA ^A_W

Serial master unit:

The unit is used as the master unit for serial master-slave operation.

S-SL ^A_W

Serial slave unit:

The unit is used as the slave unit for serial master-slave operation.

P-NA ^A_W

Parallel master unit: ※1

The unit is used as the master unit for parallel master-slave operation.

P-SL ^A_W

Parallel slave unit:

The unit is used as the slave unit for parallel master-slave operation.

※1 The number of units must be specified when configuring the unit to be the parallel master unit.

- ◆ For details about the setting procedure, see the following section "7-1-2. Specifying the number of units"

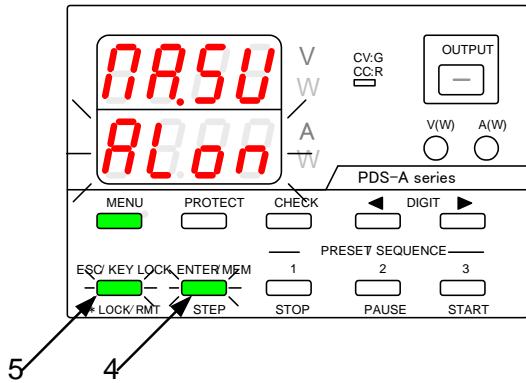

Operation procedure

- Press the green-blinking ENTER/MEM key to enter the setting.

After the setting is entered, the current indicator stops blinking, remains lit for a short while, and then starts blinking again.

- Press the green-blinking ESC/KEY LOCK key to exit. The message shown in the figure on the left appears. Normal operation of the unit is then available.

When the mode is changed, the following message is displayed:

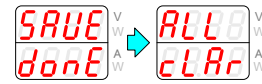

Press the green-blinking ENTER/MEM key to restart the unit.

When the unit is configured to be the serial or parallel slave unit, the display shown in the figure on the left appears.

When this display appears, turn off the power switch.



7-1-2. Specifying the number of units

Specify the number of units when configuring the unit to be the parallel master unit. If the number of units is incorrectly specified, the unit cannot be operated in parallel master-slave operation.

Unit number: 1 unit is equal to a rated output power of 200W.

An 360W model is equal to 2 units, and a 720W model is equal to 3 units.

When using a 200W model and an 360W model in parallel master-slave operation, the total number of units must be 3.

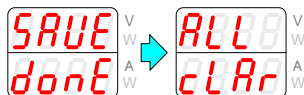
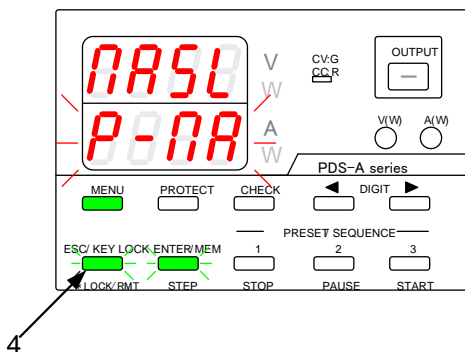
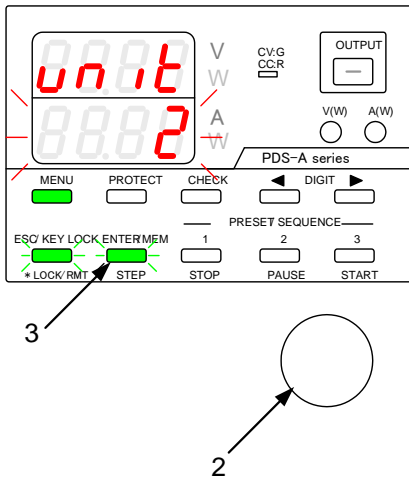
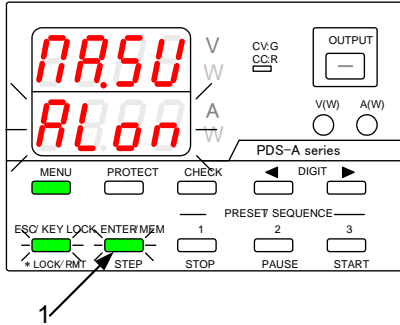

Operation procedure

Follow the steps in "[7-1-1. Configuring the master and slave units](#)" to configure the unit as the parallel master unit.

1. Press the ENTER/MEM key.
2. Turn the rotary encoder to specify the number of units (including the master unit) for parallel master-slave operation 2 to 6 units can be selected.
3. Press the green-blinking ENTER/MEM key to enter the setting.

After the setting is entered, the current indicator stops blinking, remains lit for a short while, and then starts blinking again.

4. Press the green-blinking ESC/KEY LOCK key. The message shown in the figure on the left appears.

If the same number of units has already been specified for "P-PA", the following message is displayed. The unit then restarts.



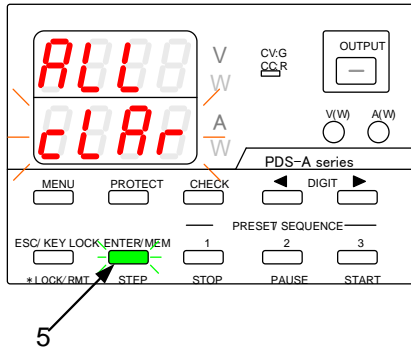

Operation procedure

5. Press the green-blinking ENTER/MEM key.
The message shown in the figure on the left appears, and then the unit restarts. All the settings, except for the communication address and master-slave operation settings, are cleared. Normal operation of the unit is then available.

If the specified number of units does not match the number that is internally read out by the unit, "SCAn" and "Err.N" are displayed.



Number of units detected

After configuring the unit to be the parallel master unit, turn off the power switch, and then connect the unit with the parallel slave unit(s).

7-2. Parallel Master-Slave Operation

The parallel master slave movement is possible to three same models.

Do not connect models with different rated output voltage for parallel master-slave operation. Doing so may cause the unit to malfunction.

One PDS-A power supply unit should be configured as the parallel master unit, and the other units as the parallel slave units.

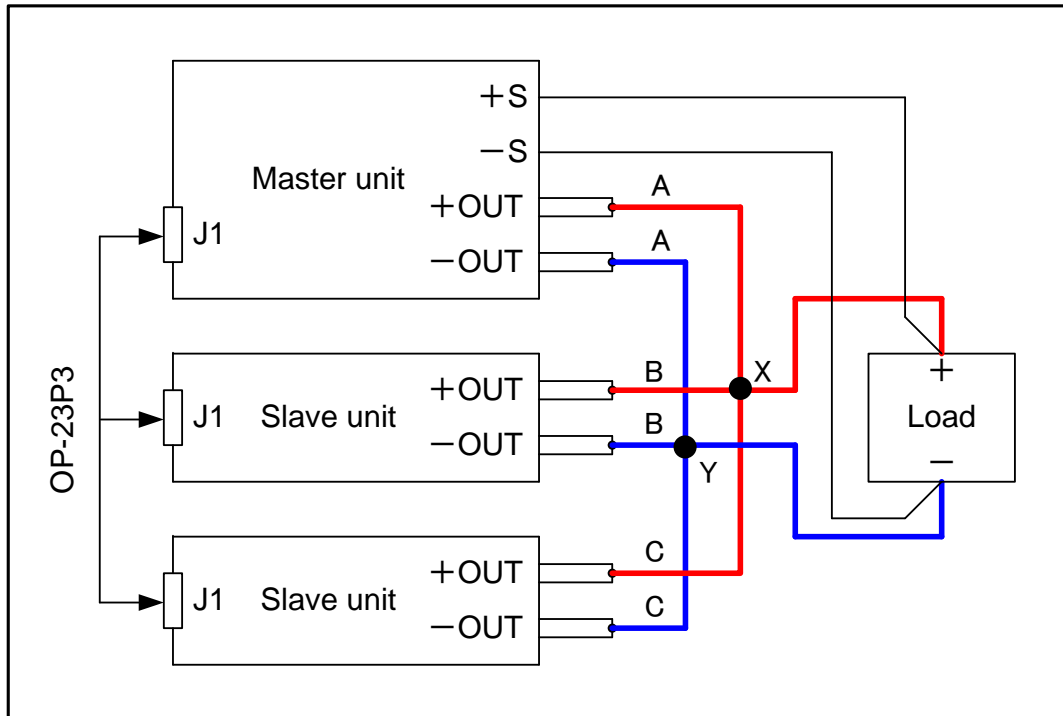

- Connect OP-23P3 (optional) to the J1 connector, which is located on the rear panel. This is the connector used to connect the master unit to the slave units.
- When applying the voltage remote sensing function, use the voltage remote sensing terminal of the master unit



Precautions for connecting the master unit and slave units:

- **DO NOT use OP-23S.** This cable is used for serial master-slave operation. If the OP-23S cable is used, the control signals from slave units will become unstable and slave units may reach maximum output. This may cause the unit to malfunction or destroy the load.
- Use low-resistance cables to connect to the positive and negative output terminals of the master and slave units. If there is large potential difference between the output terminals of the master and slave units, particularly the negative terminals, there may be a difference between the actual current and the current displayed. Please prepare length of load line A,B,C by wiring of the plus side for connection point X in an upper figure to lower the displayed current value and difference with the electric current level which really flows. Please wire the positive side of the load from connection point X. Similarly, the wiring of the negative side please prepare the length of load line A,B,C for connection point Y. Please wire the negative side of the load from connection point Y.

7-3. Serial Master-Slave Operation

The series master slave movement is possible to two same models. Do not use models with different rated current for serial master-slave operation. Doing so may cause the unit to malfunction.

One unit should be configured as the serial master unit, and another unit as the slave unit.

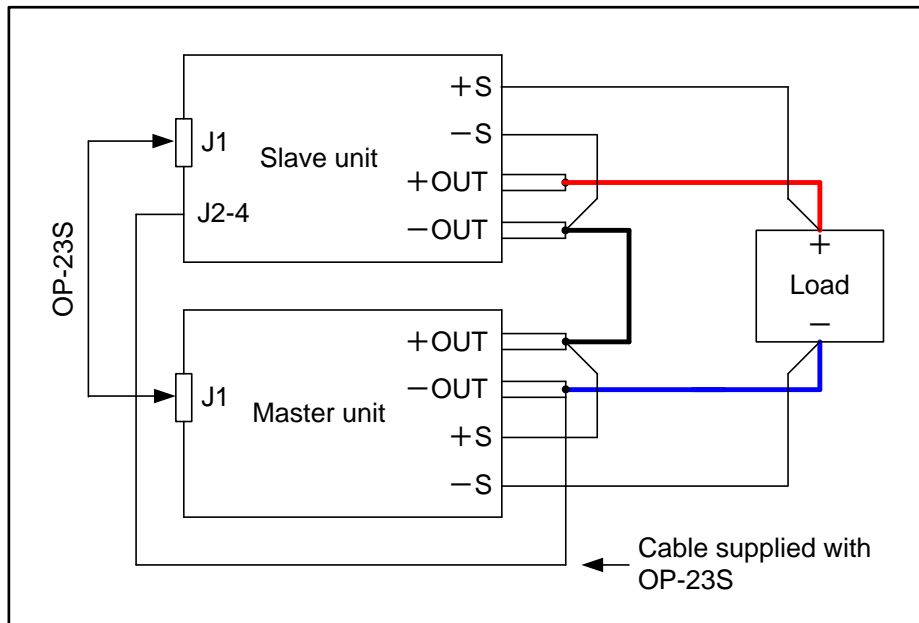

1. Connect the positive output terminal of the master unit to the negative output terminal of the slave unit, and connect the negative output terminal of the master unit to the negative side of the load. Connect the positive output terminal of the slave unit to the positive side of the load.
2. Use OP-23S (optional) to connect the J1 connectors of the master and slave units.
The J1 connectors are located on the rear panels.
3. Use the cable supplied with OP-23S to connect pin No.4 for the J2 connector of the slave unit to the negative output terminal of the master unit. The J2 connector is located on the rear panel.
4. When applying the voltage remote sensing function, use the voltage remote sensing terminals on the master and slave units.



Precautions for connecting the master unit and slave units:

- **DO NOT** use OP-23P3 . These cables are used for parallel master-slave operation.
- If OP-23P3 is used, the positive and negative outputs of the master slave will short-circuit. This may cause the unit to malfunction.
- If 2 PDS-A power supply units are connected as shown in illustration above, the 2 units will perform serial master-slave operation, even if the master unit is set for stand-alone. In this situation, double the amount set voltage will be output from the units This may cause an accident or destroy the load. Be sure to configure the master unit as the serial master unit.

8. SEQUENCE OPERATION

The PDS-A power supply unit itself cannot set sequence programs.

To set sequence programs, mount the optional digital IF board (IF-70Series) and set the sequence programs in the unit via a personal computer, etc.

After setting the sequence programs, the programs can be executed without using the digital IF board.

Sequence programs can be executed in both parallel and serial master-slave operation.

If the master-slave setting is modified, the settings for sequence programs stored in the unit will be cleared.

Refer to "7-1-1. Configuring the master and slave units"

During sequence operation, the voltage/current setting function, preset functions, and the output off timer are not available. In addition, the output cannot be turned on via the OUTPUT key.

8-1. Setting of Sequence Operation

8-1-1. Turning on the power switch with sequence operation

Following the steps in "8-1-2. Setting the unit to start in sequence operation by turning the power switch on" enables sequence operation after turning on the power switch. When the unit is set for manual operation, turn on the power switch while pressing the PRESET 3 key.

8-1-2. Setting the unit to start in sequence operation by turning the power switch on

Setting the unit to operate in sequence mode when the power switch is turned on.

Operation procedure

1. Turn on the power switch while pressing and holding the MENU key.

Release the MENU key when the panel is lit.

The MENU key is then lit in green, and the ESC/KEY LOCK key and the ENTER/MEM key start blinking green.

The function name is displayed in the voltage indicator, and the function setting is displayed (blinking) in the current indicator.

2. Repeatedly press the MENU key until "SEq" is displayed in the voltage indicator.

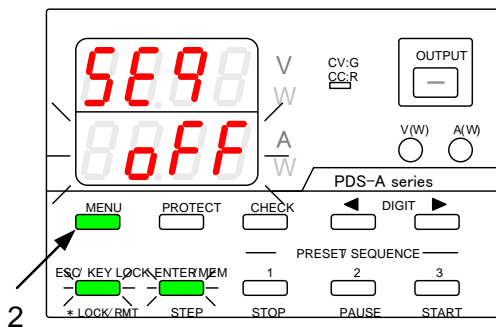
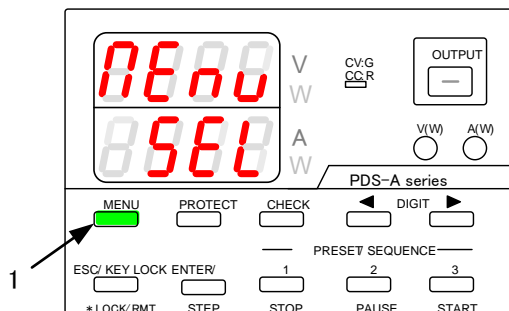

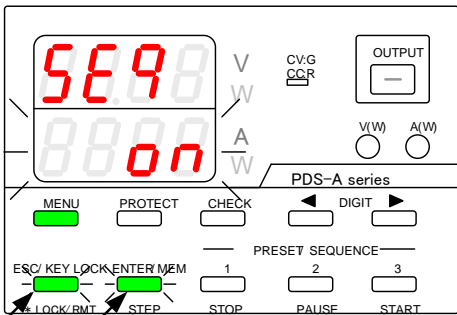
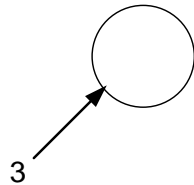
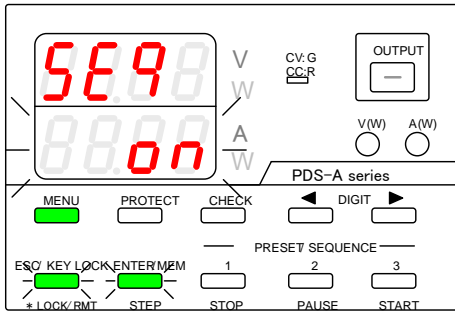

5
4

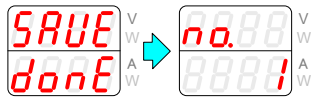

Operation procedure

- Turn the rotary encoder to display "on" in the current indicator.

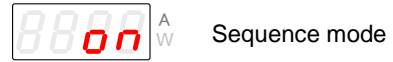

- Press the green-blinking ENTER/MEM key to enter the setting.

After the setting is entered, the current indicator stops blinking, remains lit for a short while, and then starts blinking again.

- Press the green-blinking ESC/KEY LOCK. The message shown in the figure on the left appears. The display then exits setting mode and switches to sequence mode.

8-2. Sequence Programs

A sequence program consists of the settings for each step, and the step execution settings.

8-2-1. Step No. and setting items

There are 1000 steps. The following items must be specified for each step.

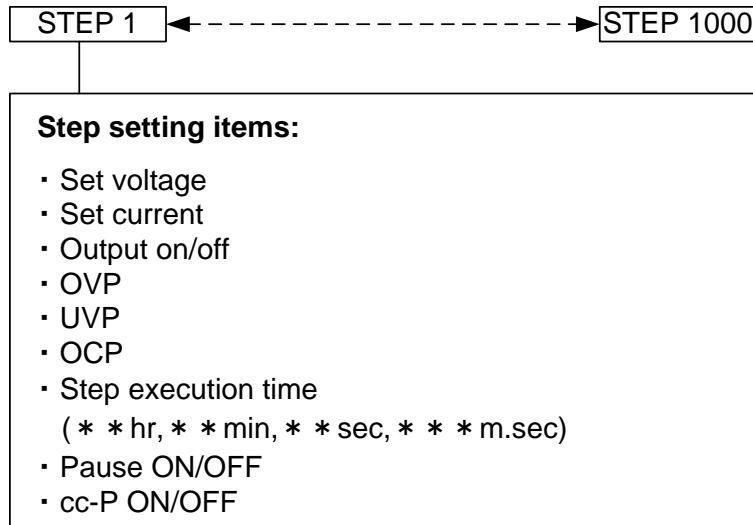

8-2-2. Setting step execution

The step execution range is from "start step" to "end step".

The number of execution cycles can be from 1 to 1000, or infinite.

There are four execution modes available. Select the desired mode.

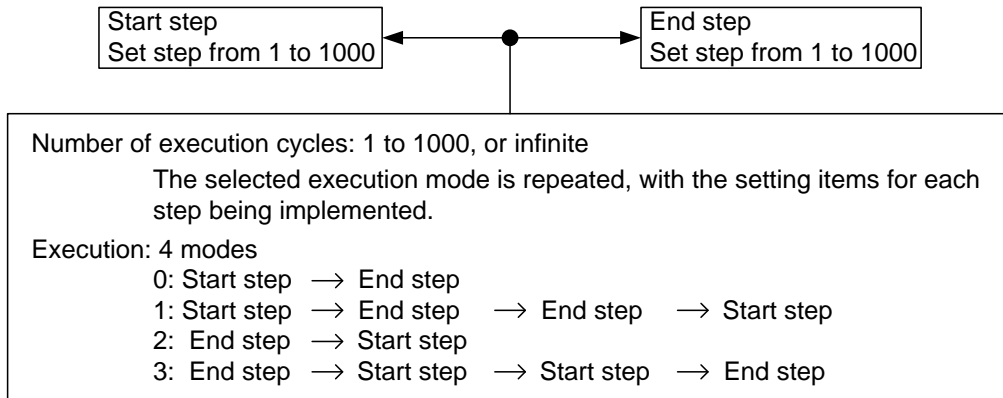

8-3. Confirming the Step No. and the Step Being Executed

The step No. and step being executed can be confirmed while the STEP LED is lit in green.

8-3-1. Confirming the step No. while the sequence program is stopped

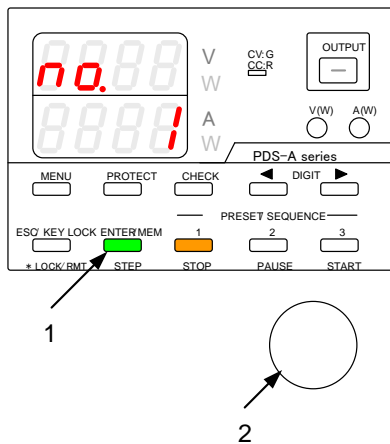

Operation procedure

1. Press the STEP key when the STOP key is lit in amber (while the sequence program is stopped). The STEP key is then lit in green.

The voltage indicator displays "no".
The current indicator displays the step No.

2. Turn the rotary encoder to change the step No. Only the step numbers from start step to end step are displayed.

8-3-2. Confirming the step No. being executed during sequence program execution

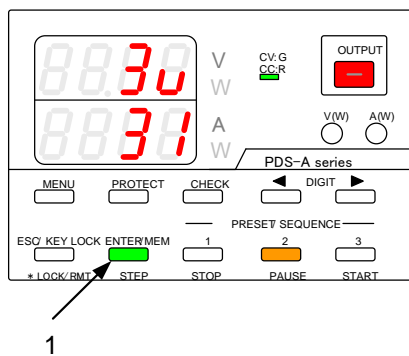

Number of executed program cycles

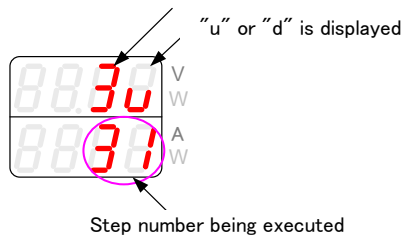

Operation procedure

1. Press the STEP key while the PAUSE key or START key is lit in amber (while a sequence program is being executed). The STEP key is then lit in green.

The voltage indicator displays the number of executed program cycles, and the direction in which the program is being executed.
The current indicator displays the step No. being executed.

The figure on the left indicates that the program is in the 3rd execution cycle, from the start step to the end step, and that step 31 is being executed.

The maximum number of execution cycles for a sequence program is "999".
The 1000th cycle is displayed as "0".

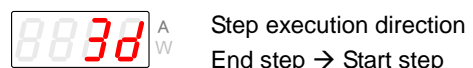
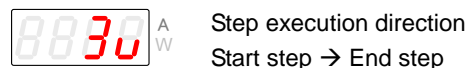

8-4. Confirming the Setting Items for Steps.

You can confirm the step setting items.

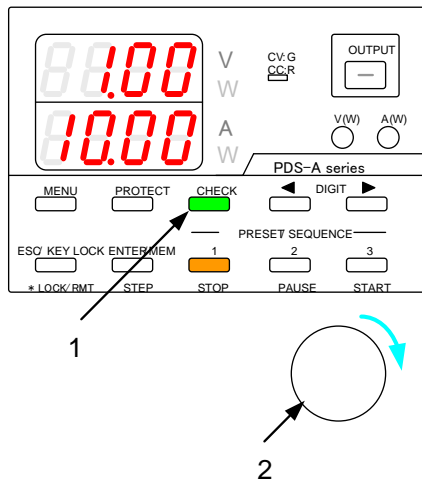

Operation procedure

1. Press the CHECK key, which is then lit in green.

The voltage and current indicators display the step setting items.

2. While the STOP key or PAUSE key is lit in amber (while the sequence program is stopped or paused), turn the rotary encoder clockwise 1 click to switch between the different step setting items. The setting items are displayed in the voltage and current indicators.

See the table below for details about the step setting items.

Voltage indicator	Current Indicator	Setting item	Remarks
Set voltage	Set current	Voltage/current	
Out	on	OUTPUT	When the output HI-R function is on, the output is set to off.
	oFF		
	Hi-r		
Set OVP	oVP	OVP value	
Set UVP	uVP	UVP value	
Set OCP	oCP	OCP value	
H	n	Execution time (hr, min)	The execution time can be set to the m sec. However, the set time is rounded up to 10m sec. when applying setting items.
Sec.	m sec.	Execution time (sec, m sec)	If the execution time is 0 hr 0 min 0 sec 0m sec, the step is skipped and the setting items are not executed.
PAuS	oFF	PAUSE	If the pause setting is on, the sequence program will pause when the step is finished.
cc-P	on/oFF	CC priority output setting	

While a sequence program is being executed automatically (while the START LED is lit in amber), only the set voltage and current can be confirmed. The other step setting items cannot be confirmed.

8-5. Confirming the settings for sequence program execution

The setting items for sequence program execution can be confirmed while the MENU key is lit in green.

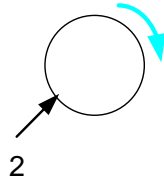
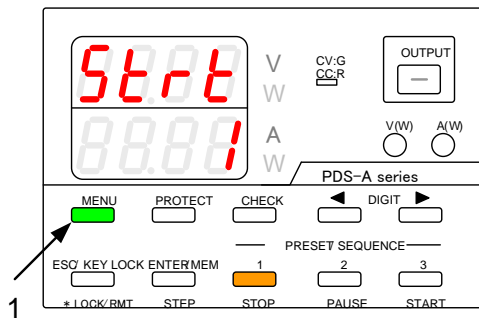

Operation procedure

1. Press the MENU key, which is then lit in green.

The voltage and current indicators display the setting items for sequence program execution.

2. While the STOP key or PAUSE key is lit in amber (while the sequence program is stopped or paused), turn the rotary encoder clockwise 1 click to switch between the setting items for sequence program execution. The setting items are displayed in the voltage and current indicators.

See the table below for details about the setting items for sequence program execution.

Voltage indicator	Current indicator	Setting item for sequence program execution	Remarks
StAt	STEP No.	START STEP	
End	STEP No.	END STEP	
cycL	Number of execution cycles	Number of execution cycles	The number of execution cycles that can be displayed is 1 to 1000. "InF" indicates an infinite number of execution cycles.
ΠodE	Execution mode	Execution mode	The execution modes are as follows: 0: START STEP→END STEP 1: START STEP→END STEP→END STEP →START STEP 2: END STEP→START STEP 3: END STEP→START STEP→START STEP →END STEP

When a sequence program is being executed automatically (while the START LED is lit in amber), only the execution time of the step being executed can be confirmed. The other setting items cannot be confirmed. The voltage indicator displays the hour, and the current indicator displays the minutes and seconds.

8-6. Executing Sequence Programs

The START, PAUSE, STOP, and OUTPUT keys are used to execute sequence programs.

8-6-1. Automatic execution of sequence programs

A sequence program can be set to execute automatically from the first step of the program.

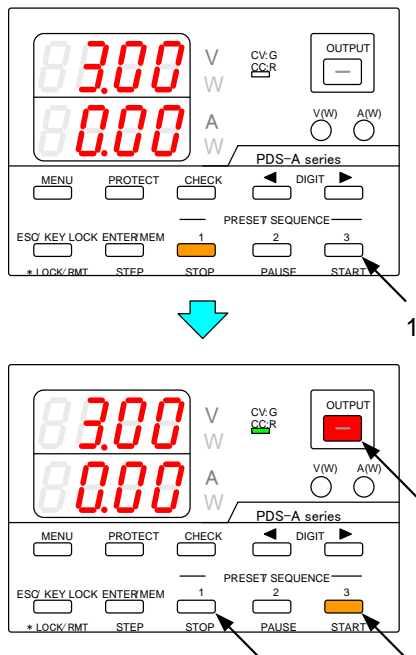

Operation procedure

1. While the STOP key is lit in amber (while the sequence program is stopped), press the START key. The START key is then lit in amber.

When a sequence program is set to execute automatically, the voltage and current indicators display the output values.

When a sequence program is executed automatically, the step to be executed first varies according to the execution mode that has been selected.

◆ See the figure below for details.

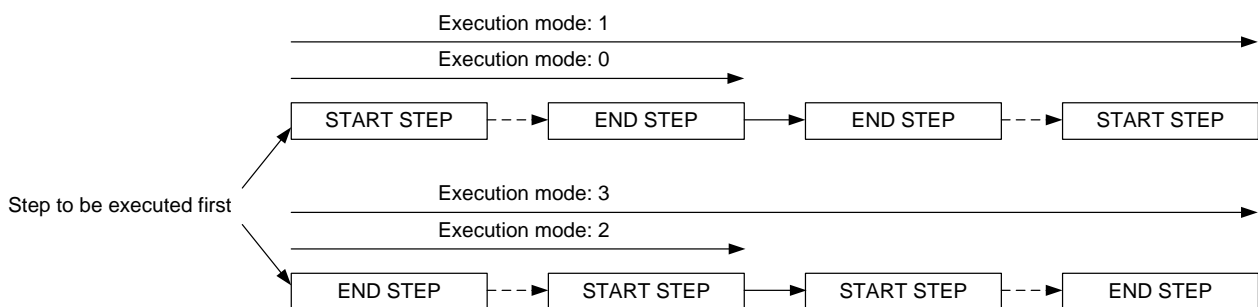

Automatic execution cannot start from a step that is in the middle of the sequence program.

8-6-2. Paused and resumed sequence programs

A sequence program can be paused and resumed.

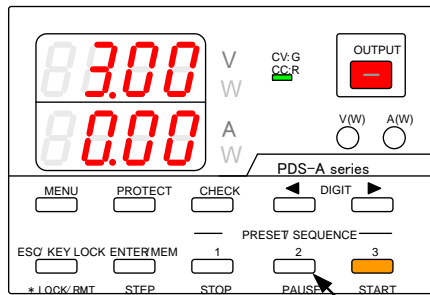

1

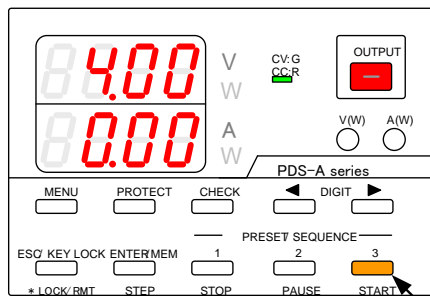

2

Operation procedure

1. While the START key is lit in amber (while the sequence program is being executed automatically), press the PAUSE key. The PAUSE key then is lit in amber, and the sequence program is paused.
2. While the sequence program is paused, press the START key to resume automatic execution of the program (the START key is then lit in amber again).

The step resumes from the time where it stopped when the PAUSE key was pressed in operation procedure 1.

While a sequence program is paused, only the step execution time is paused. The other step setting items continue being executed. If the output is set to be on for the step being executed, the unit output will be on.

8-6-3. Manual execution of sequence programs

The PAUSE key and DIGIT keys ◀ ▶ are used to manually execute sequence programs

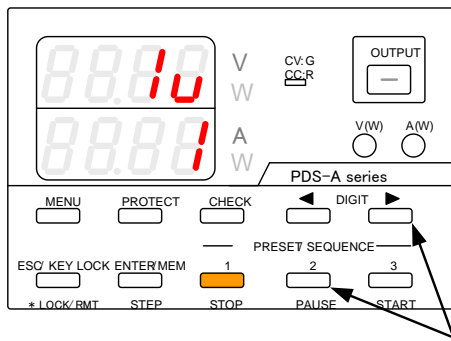

1

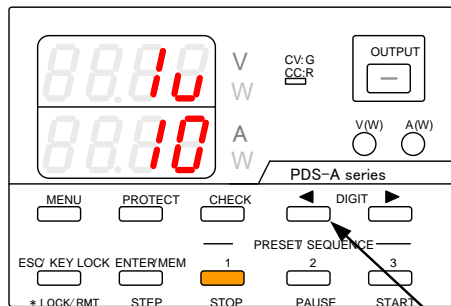

2

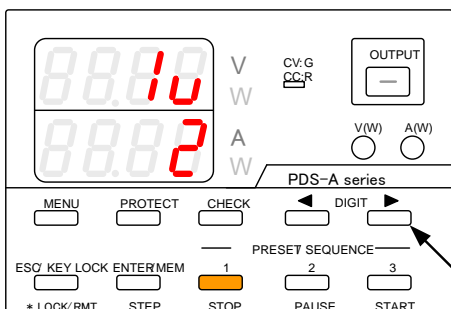

3

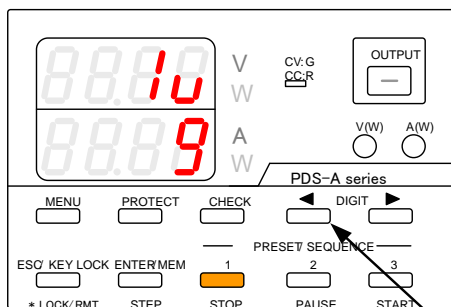

4

Operation procedure

1. While the STOP key is lit in amber (while the sequence program is stopped), press the PAUSE key or DIGIT key ▶ to pause the sequence program at the first step (if the PAUSE key is pressed, it is then lit in amber).

See next page for details about the steps to be executed.

2. While the STOP key is lit in amber (while the sequence program is stopped), press the DIGIT key ◀ to pause the sequence at the last step.

See next page for details about the steps to be executed.

3. Press the DIGIT key ▶ to pause the program at the next step.

4. Press the DIGIT key ◀ to pause the program at the previous step.

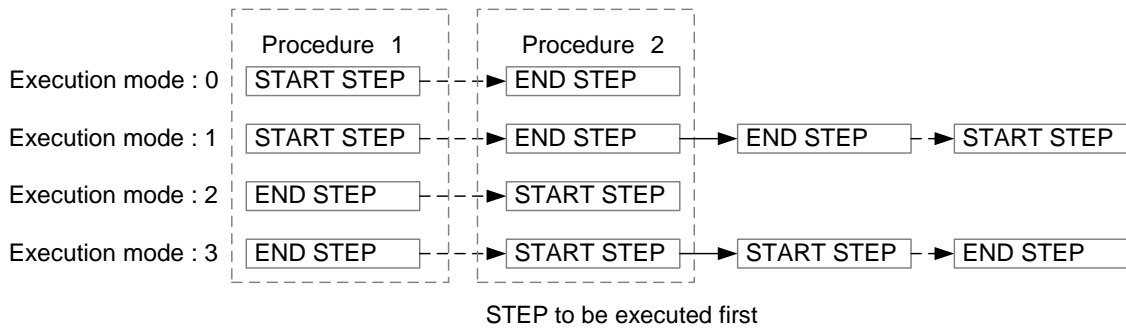

When the DIGIT keys ◀ ▶ are pressed to move to the next step or back to the previous step, if the execution time of the step to be executed next is 0 hr 0 min 0 sec 0 m.sec, the step will not be executed. The following step will be executed.

8-6-4. Stopping sequence programs

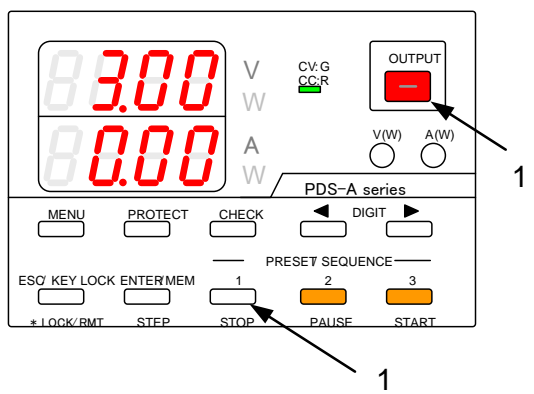

Operation procedure

1. To stop the sequence program, press the STOP key while the START key is lit in amber (while the sequence program is being executed automatically) or while the PAUSE key is blinking amber (while the execution time of the sequence program step is paused).

When the sequence program is stopped, the voltage and current indicator display the step No. that was being executed.

Both the STOP key and OUTPUT key can be used to stop the sequence program.

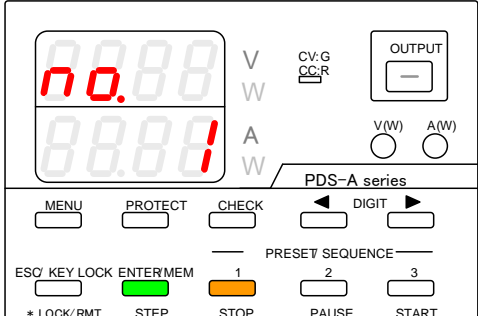

When a sequence program is stopped, the output will be turned off, even if the output is set to be on for the stopped step.
If a sequence program is stopped, it cannot be restarted from the stopped step.

9. OPERATION BY EXTERNAL ANALOG SIGNAL

The PDS-A series unit can be operated by using an analog signal from an external device.

Replace the interface board according to the type of operation signal used.

The following IF boards can be used with the PDS-A power supply unit:

- **Standard board** :Used when the PDS-A power supply unit is operated by using an analog signal from an external device.

9-1. Analog Interface Boards

When you install a standard board (hereafter analog IF board) in the unit, you can perform the following operations:

- Turn the output on/off and the main relay on/off through external contacts.
- Change set voltage and current by external voltage or external resistance.
- Output various status signals (alarm, CV, CC, and protection).

9-1-1. Cautions on applying analog IF boards

Be sure to observe the following points when using and installing an analog IF board in the unit.

- When using an external analog signal to operate the unit, the outer contact, voltage, and resistance applied for the operation must be float-mounted.
If the outer contact, voltage, and resistance are not float-mounted, the unit's output may short-circuit. This may cause the unit to malfunction.
- The SW 1 (switch 1) of the analog IF board is read out when the power switch of the unit is turned on.
Be sure to turn off the power switch before specifying the settings for SW 1.
Specifying settings for SW 1 while the power switch is on may cause the unit to malfunction.
- The set voltage/current value represents the externally set voltage/current value, which is superimposed by the internally set voltage/current value. When the power switch is turned on and the status of the analog IF board is read out, if it is detected that the dip switch setting has been modified or that the analog IF board has been replaced, all the set current and voltage values will be 0V and 0A, including the set voltage and current values stored in PRESET 1 to 3. This is done to prevent the set voltage and current from reaching values that may put the load at risk.

When the power switch is turned on and "VA cLAr" appears in the voltage and current indicator displays, as shown in the figure below, press the blinking MEM/ENTER key. The message "cLAr donE" appears in the indicator, and it is now possible to turn the power switch on or off.

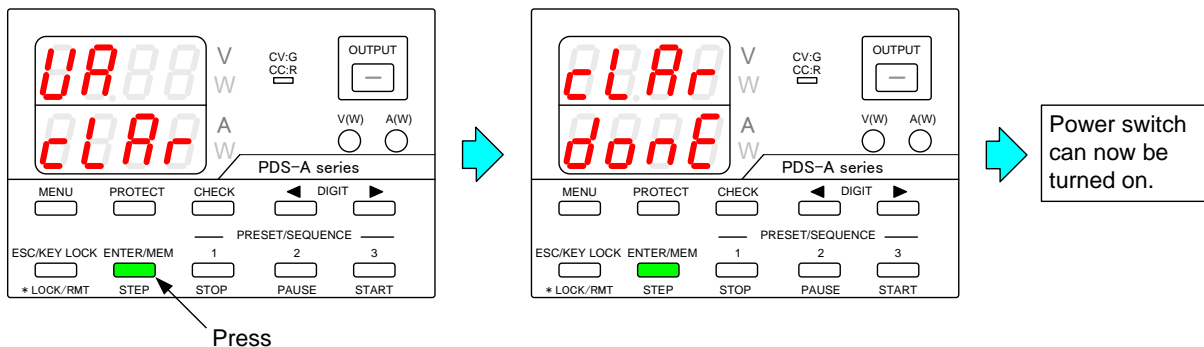

9-1-2. Wiring an analog signal to the standard board

See the figure below for details about how to wire an analog signal to the standard board, and how to select the logic and different functions.

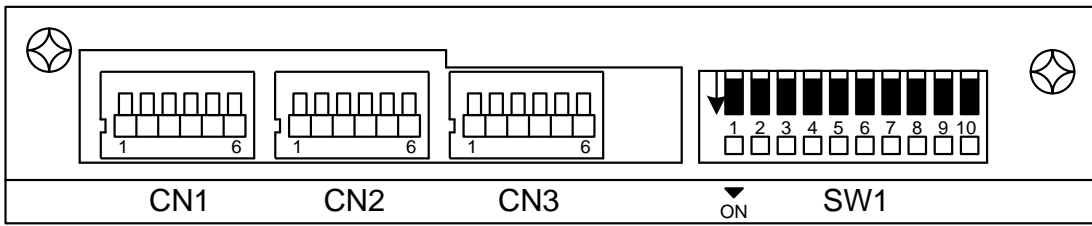
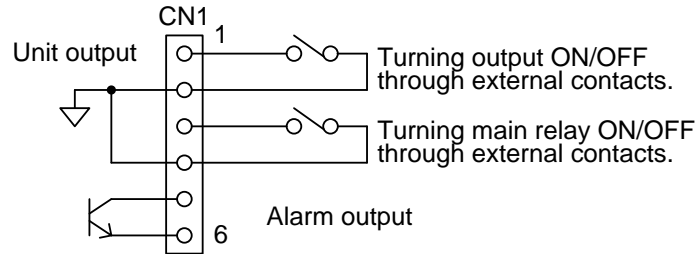

Fig. 9-1. Standard Board Connector and Dip Switch

While the unit is in operation, connect the applicable outer contact, voltage, and resistance to the negative output of the unit.

Note that the outer contact, voltage, and resistance must be float-mounted.

The photo-coupler, which is used to output alarms and the status of CV mode and CC mode, must be used at a current of 5mA or lower when it is on, and at a voltage of 10V or lower when it is off.



Function	Connection terminal	SW1		Action
Main relay on/off	Pin No.3 to 4 of CN1	Pin No.1 of SW1	OFF	Close circuit: Main relay off Open circuit: Main relay on
			ON	Close circuit: Main relay on Open circuit: Main relay off
Output on/off	Pin No.1 to 2 of CN1	Pin No.2 of SW1	OFF	Close circuit: Output off Open circuit: Output on
			ON	Close circuit: Output on Open circuit: Output off
Alarm output	Pin No.5 to 6 of CN1	Pin No.3 of SW1	OFF	Photo-coupler on when status is alarm Photo-coupler off when status is normal
			ON	Photo-coupler off when status is alarm Photo-coupler on when status is normal

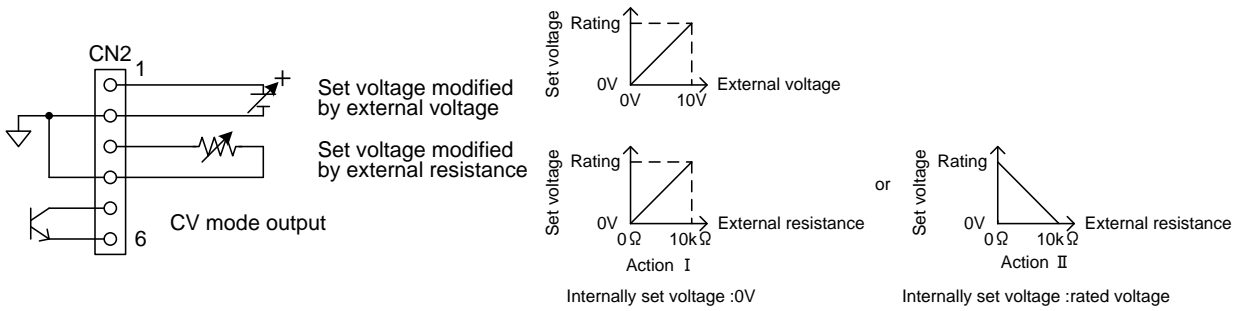

Set voltage control via external signal (Valid when pin No.4 of SW1 is on)

Function	Connection terminal	Pin No.5 of SW1	Pin No.6 of SW1	Action
External voltage control	Pin No.1 to 2 of CN2	ON	ON	External voltage 0V → 10V Set voltage 0V → Rated voltage
External resistance control: Action I	Pin No.3 to 4 of CN2	ON	OFF	External resistance 0Ω → 10kΩ Set voltage 0V → Rated voltage
External resistance control: Action II		OFF	ON	External resistance 0Ω → 10kΩ Set voltage: Rated voltage → 0V
CV mode output	Pin No.5 to 6 of CN2			Photo-coupler is on while in CV mode

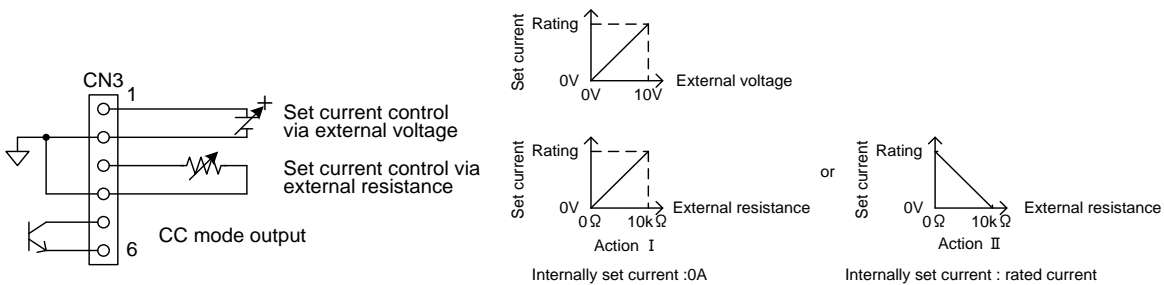

Set current control by external signal (Valid when pin No.7 of SW 1 is on)

Function	Connection terminal	Pin No.8 of SW1	Pin No.9 of SW1	Action
External voltage control	Pin No.1 to 2 of CN3	ON	ON	External voltage 0V → 10V Set current 0A → Rated current
External resistance control: Action I	Pin No.3 to 4 of CN3	ON	OFF	External resistance 0Ω → 10kΩ Set current 0A → Rated current
External resistance control: Action II		OFF	ON	External resistance 0Ω → 10kΩ Set current: Rated current → 0A
CC mode output	Pin No.5 to 6 of CN3			Photo-coupler is on while in CC mode

- ◆ See "9-2-2. Adjusting the set voltage" and "9-2-3. Current setting" for details about how to set the internal voltage and current.

If the standard board has been installed in the unit, the connectors (CN1, 2, 3), are arranged in the same way as shown in the above figure.

The board features screwless connectors. Press the button of the connector and insert the cable (from which 10 mm of the isolation coat has been stripped) into the hole on the left side of the button.

Use the AWG#24 - #28 cables (UL1007 stranded wire).

9-2. Operating the Analog IF Board

9-2-1. Setting the Voltage

When using the unit with a set voltage that is specified by an external resistance or voltage (hereinafter referred to as the "externally set voltage"), the set voltage value represents the internally set voltage (set by the rotary encoder) which is superimposed by the externally set voltage. While the CHECK key is lit in green, if the V key is unlit or lit in amber, the voltage setting of the internally + externally set voltage is displayed in the voltage indicator. When the V key is lit in green, the voltage setting of the internally set voltage is displayed in the voltage indicator.

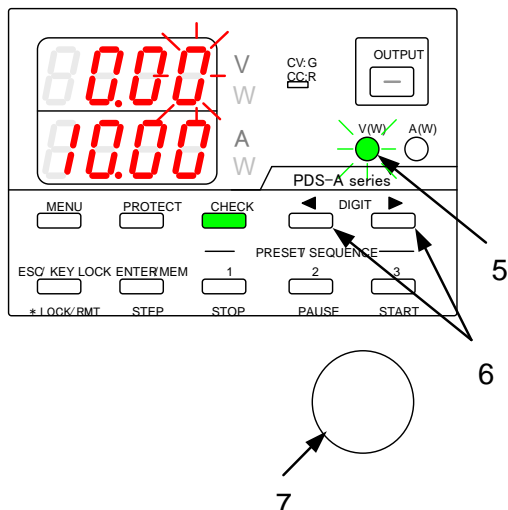
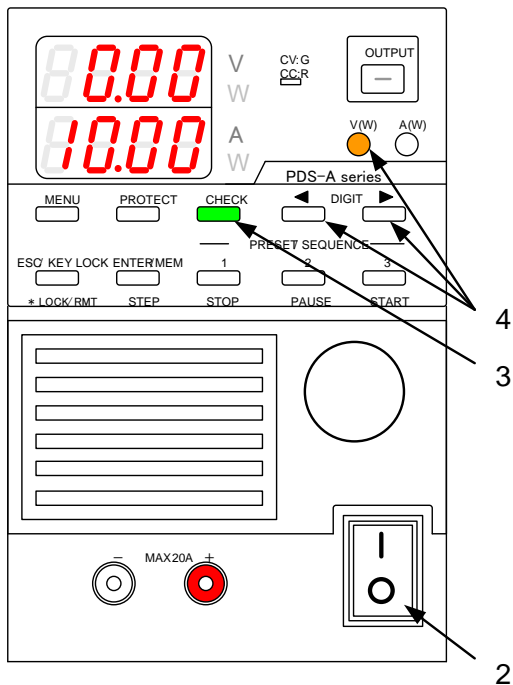
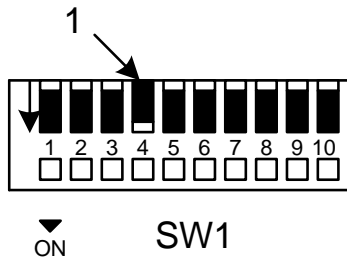

Operation procedure

Confirm that the power switch has been turned off.

1. Turn on No. 4 of SW 1, located on the analog IF board. Use an external analog signal to set No. 5 and 6 of SW 1.

◆ For details, see [“9-1-2. Wiring an analog signal to the standard board”](#).

To switch over the dip switch, use a needle-nosed tool such as a straight-slot screwdriver.

2. Turn on the power switch.
3. Press the CHECK key, which is then lit in green. The voltage indicator displays the set voltage value, which is the internally set voltage superimposed by the externally set voltage. The current indicator displays the set current.
4. Press the V key while pressing and holding one of the DIGIT ◀ ▶ keys. The V key is then lit in amber.
5. Press the V key again. It then begins to blink green.

The internally set voltage is displayed (blinking) in the voltage indicator.

6. Press the DIGIT ◀ ▶ keys to move the blinking digit in the voltage indicator.
7. Turn the rotary encoder to modify the internally set voltage.

The variable range of internally set voltage is from -5% to +105% of the rated voltage.

The internally set voltage varies according to the applied external signal.

◆ For details, [“9-1-2. Wiring an analog signal to the standard board”](#)

Operation procedure

8. Press the green-blinking V key.
The light then goes out.

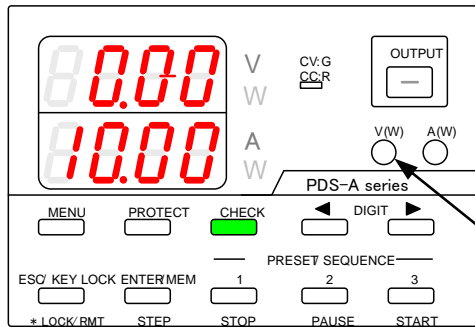

Input the external analog signal into the connector on the analog IF board.

The voltage indicator displays the set value that corresponds to the external analog signal.

The display range of the set voltage is from -10% to +110% of the rated voltage.

The analog IF board connector varies according to the type of external analog signal.

- ◆ For details, ["9-1-2. Wiring an analog signal to the standard board"](#)

The voltage that can be set by performing this operation may exceed the maximum rated voltage of the unit, depending on how it is used.

When the voltage is set lower than 0V or higher than 102.5% of the rated voltage, all the digits on the voltage indicator will blink, and the output will be turned from on to off.

9-2-2. Adjusting the set voltage

Modify the internally set voltage to adjust the set voltage specified by the externally set voltage.

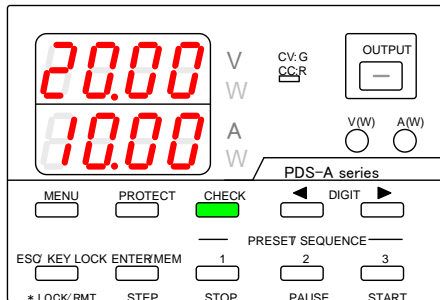
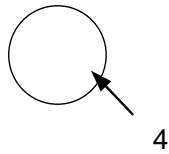
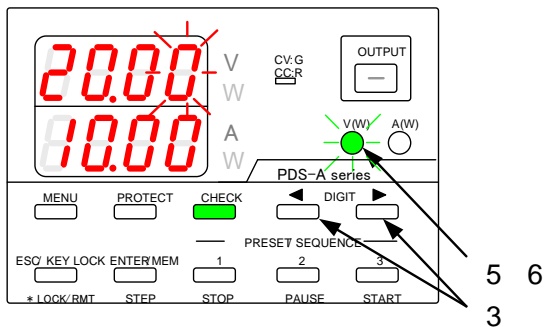
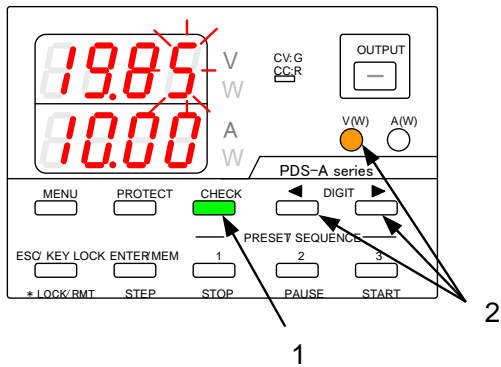

Operation procedure

- ◆ See "9-2-1. Setting the Voltage" for details about how to input the external analog signal into the connector of the analog IF board.

1. Press the CHECK key, which is then lit in green. The voltage indicator displays the set value that corresponds to the external analog signal.
2. Press the V key while pressing and holding one of the DIGIT ◀ ▶ keys. The V key then is lit in amber.

A digit starts blinking in the voltage indicator. The current indicator displays the value of the internally set voltage.

3. Press the DIGIT ◀ ▶ keys to move the blinking digit in the voltage indicator.
4. Turn the rotary encoder to modify the internally set voltage.
5. Press the V key. The key then starts to blink green.
6. Press the green-blinking V key. The light then goes out. The blinking digit in the voltage indicator stops blinking and then remains lit.

9-2-3. Current setting

When using the unit with a set current that is specified by an external resistance or voltage (hereinafter referred to as the "externally set current"), the set current value represents the internally set current (set by the rotary encoder) which is superimposed by the externally set current. While the CHECK key is lit in green, if the A key is unlit or lit in amber, the current setting of the internally + externally set current is displayed in the current indicator. When the A key is lit in green, the current setting of the internally set current is displayed in the current indicator.

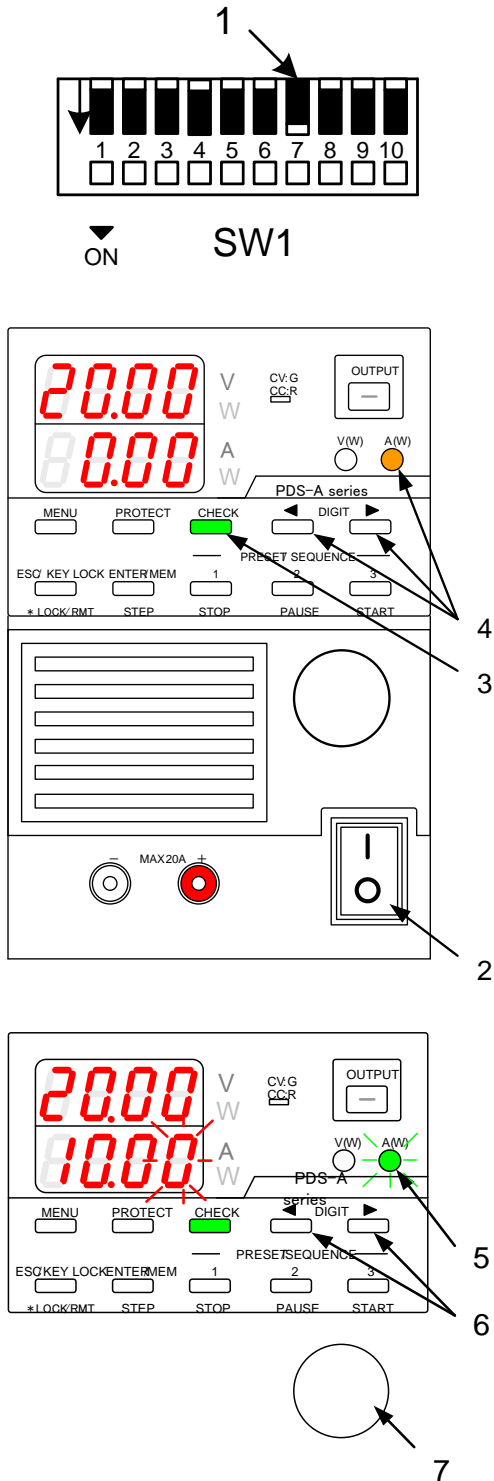

Operation procedure

Confirm that the power switch has been turned off.

1. Turn on No. 7 of SW 1, which is located on the analog IF board.
Use an external analog signal to set No. 8 and 9 of SW 1.

◆ For details, "9-1-2. Wiring an analog signal to the standard board"

To switch over the dip switch, use a needle-nosed tool such as a straight-slot screwdriver.

2. Turn on the power switch.
3. Press the CHECK key, which is then lit in green. The voltage indicator displays the set voltage. The current indicator displays the set current value, which is the internally set current superimposed by the externally set current.
4. Press the A key while pressing and holding one of the DIGIT ◀ ▶ keys. The A key is then lit in amber.
5. Press the A key again. The key then starts to blink green.

The internally set current is displayed (blinking) in the current indicator.

6. Press the DIGIT ◀ ▶ keys to move the blinking digit in the current indicator.
7. Turn the rotary encoder to modify the internally set current.

The variable range of internally set current is from -5% to +105% of the rated current.

The internally set current varies according to the externally applied signal.

◆ For details, "9-1-2. Wiring an analog signal to the standard board"

Operation procedure

8. Press the green-blinking A key.
The light then goes out.

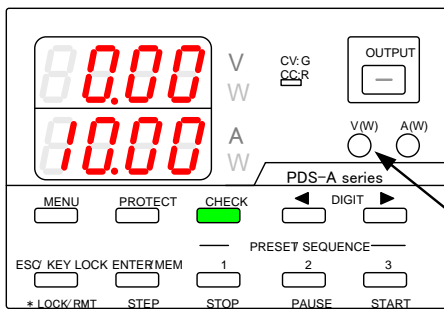

Input the external analog signal to the connector on the analog IF board.

The current indicator displays the set value that corresponds to the external analog signal.

The display range of the set current is from -10% to +110% of the rated current.

The connector of the analog IF board varies according to the type of external analog signal.

◆ For details, ["9-1-2. Wiring an analog signal to the standard board"](#)

The current that can be set by performing this operation may exceed the maximum rated current of the unit, depending on how it is used.

When the current is set lower than 0A or higher than 102.5% of the rated current, all the digits on the voltage indicator will blink, and the output will be turned from on to off.

9-2-4. Adjusting the set current

Modify the internally set voltage to adjust the set current specified by externally set voltage.

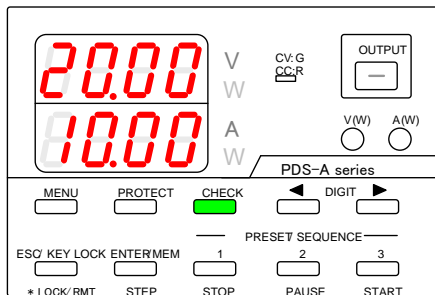
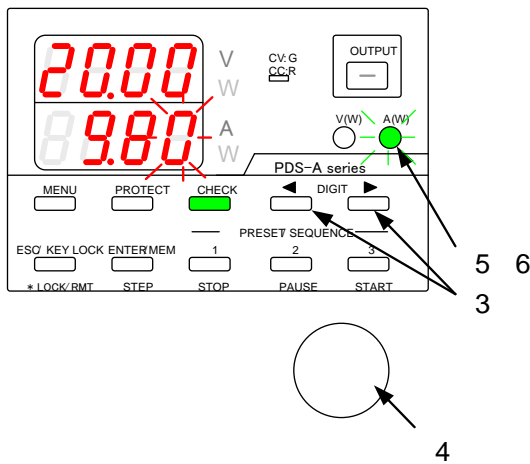
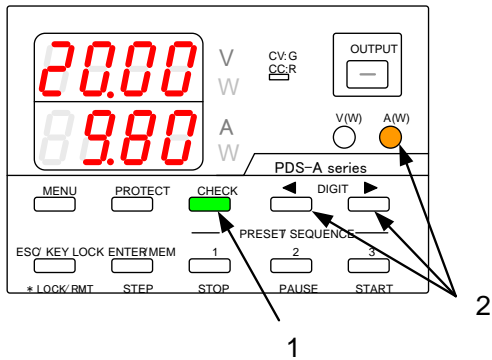

Operation procedure

◆ For details about inputting the external analog signal to connector of the analog IF board, see “9-2-3. Current setting”

1. Press the CHECK key, which is then lit in green. The current indicator displays the set current value that corresponds to the external analog signal.
2. Press the A key while pressing and holding one of the DIGIT ◀ ▶ keys. The A key is then lit in amber.

The current indicator displays the internally set current.

A digit starts blinking in the current indicator.

3. Press the DIGIT ◀ ▶ keys to move the blinking digit in the current indicator.
4. Turn the rotary encoder to modify the internally set current.
5. Press the A key. The key then starts to blink green.
6. Press the green-blinking A key. The light then goes out. The blinking digit in the current indicator stops blinking and then remains lit.

9-2-5. Turning the output on/off through external contacts

If the analog IF board is installed in the PDS-A power supply unit, you can turn the output on/off operation through external contacts.

To turn the output of the unit on, both the OUTPUT key and external contacts must be used.

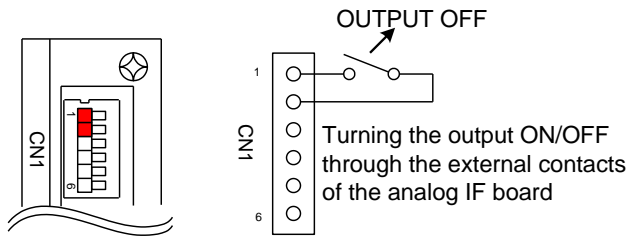

Operation procedure

Turn off the unit power switch, and turn the output off through the external contacts.

◆ For details about turning the output on/off through external contacts, see [“9-1-2. Wiring an analog signal to the standard board”](#)

1. Turn on the power switch while pressing and holding the MENU key.

Release the MENU key when the panel is lit.

The MENU key is then lit in green, and the ESC/KEY LOCK key and ENTER/MEM key start blinking green.

The function name is displayed in the voltage indicator, and the function setting is displayed (blinking) in the current indicator.

2. The output setting for when the power is turned on must be set to "on" by using the MENU key and rotary encoder.

("Pout" is displayed in the voltage indicator, and "on" in the current indicator)

◆ For details, see [“6-3-2. Setting the output when the power is turned on”](#).

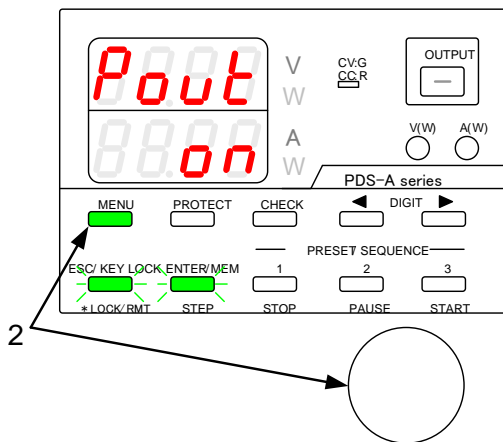
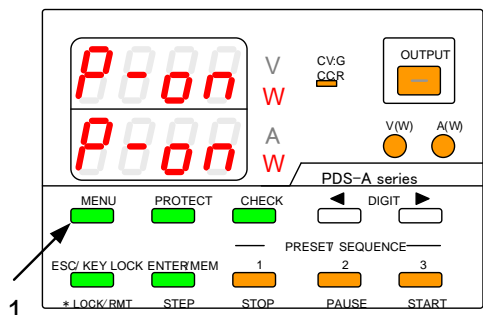

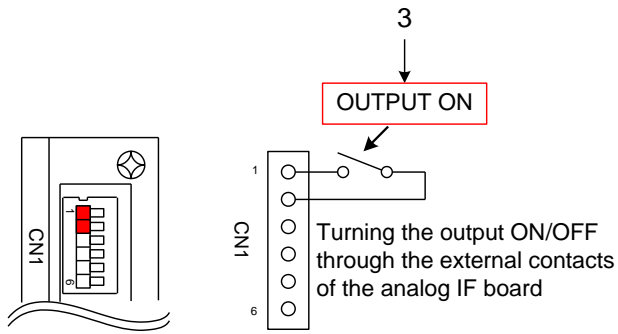

Operation procedure

- Use the external contacts of the analog IF board to turn the output on.

The OUTPUT key is then lit in green, and the output of the unit is turned on.

- Use the external contacts of the analog IF board to turn the output off.

The OUTPUT key light goes out, and the output of the unit is turned off.

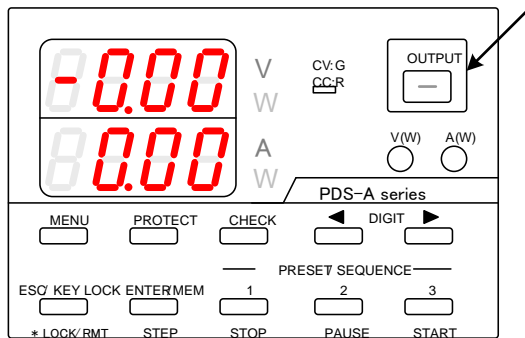
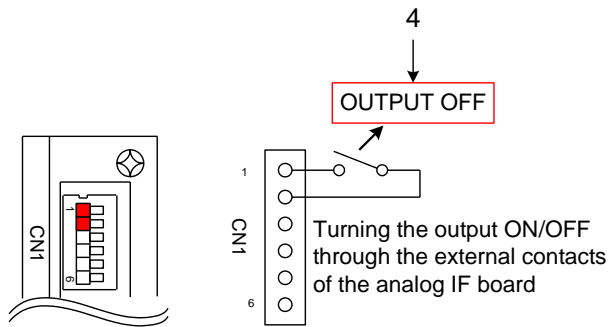
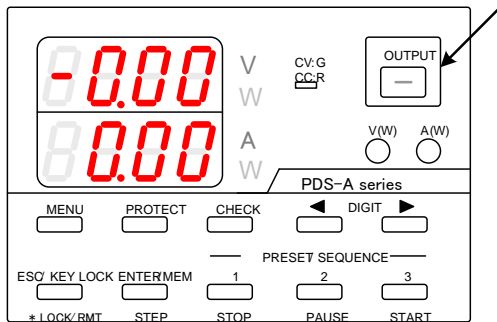

In the PDS-A power supply unit, when the output of the unit has been turned on through the external contacts of the analog IF board, the OUTPUT key on the front panel can be used to turn the output on or off during operation. Thus, in case of an emergency where the power supply from the unit to the loads must be stopped, the power supply from the unit can be stopped without needing to turn off the power switch.

9-2-6. Checking the status when the output is off

If the analog IF board has been installed in the unit and the output of the unit is off, the following items can be checked:

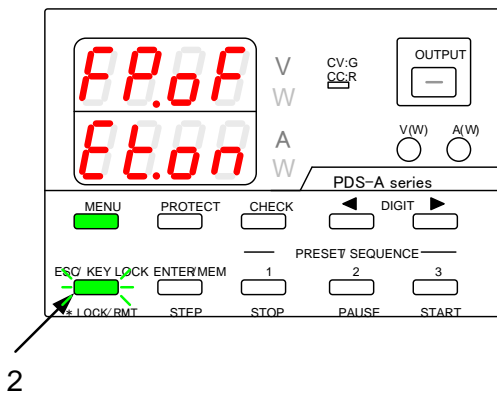
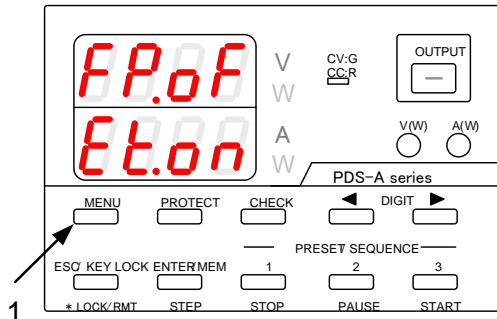

Operation procedure

1. Press the MENU key while the output is off.
The following messages are displayed:
Voltage indicator: "FP.oF"
Current indicator: "Et.xx"

The MENU key then is lit in green, and the ESC/KEY LOCK key starts blinking green.

Voltage indicator Voltage indicator



Status of output on/off setting that uses the external contacts of the analog IF board

Current indicator



2. Press the green-blinking ESC/KEY LOCK key to exit.
Normal operation of the unit is then available

If the analog IF board has not been installed in the unit, this function is not available.

9-2-7. Main relay ON/OFF operation

When the power of multiple PDS-A units is turned on at one time, a large rush of current flows into the primary side. This may generate current distortion in the AC line, affecting the devices connected to the AC line to which the PDS-A units are connected.

Specify "off" as the Main relay setting for all the PDS-A units, and then turn on the power switch. Next specify "on" as the Main relay setting for each unit, one unit at a time. This disperses the rush current on the primary side and diminishes current distortion in the AC line.

If the analog IF board has been installed and the Main relay is off, "P-oF" is displayed in both the voltage indicator and current indicator when the power switch is turned on. At this time, only the internal power supply source is running.

If the Main relay is set to "on" when external contacts of the analog IF board are closed or short-circuited, "P-on" is displayed in both the voltage indicator and current indicator. The power can then be turned on or off.

For details about how to turn Main relays on or off, see ["9-1-2. Wiring an analog signal to the standard board"](#).

Also in command of the digital communication interface can be the main relay set at the time of ON / OFF and power ON of the main relay, See ["11-3-18. Main relay setting \(POWER\)"](#) and ["11-3-24. Main relay setting when the power is turned on \(PONPOW\)"](#).

10. INTERFACE OPTION

10-1. Accessories

The supplied accessories differ according to the optional interface board (IF-70 Series or IF-71 Series) that is used.

<IF-71RS unit accessories>



Short pin 4 pcs
[E68-0617]



Instruction Manual 1 copy
[B71-0025]

<IF-70GU unit accessories>



Short pin 3 pcs
[E68-0617]



Instruction Manual 1 copy
[B71-0025]

<IF-71LU unit accessories>



Short pin 3pcs
[E68-0617]

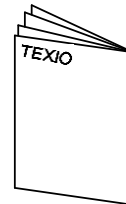

Instruction Manual 1 copy
[B71-0210]

11. USING DIGITAL COMMUNICATION INTERFACE FOR REMOTE CONTROL

11-1. Outline

If a digital communication interface has been installed in place of the standard board, the PDS-A series unit can be remotely controlled by a personal computer (hereinafter "PC") or sequencer via a USB, GP-IB, or RS-232C.

Because the digital communication interface has a local bus, a single PC or sequencer can control multiple PDS-A series units.

The optional digital communication interface boards (referred as "digital IF board" hereinafter) for the PDS-A series are as follows:

- IF-70GU: Used with GP-IB and USB digital communication interfaces. Can be connected to a PC for remote control.
- IF-71LU: Used with GP-IB and USB digital communication interfaces. Can be connected to a PC for remote control.
- IF-71RS: Used with communication interfaces that are compatible with RS-232C. Can be connected to a PC or sequencer for remote control.

11-1-1. IF-70GU

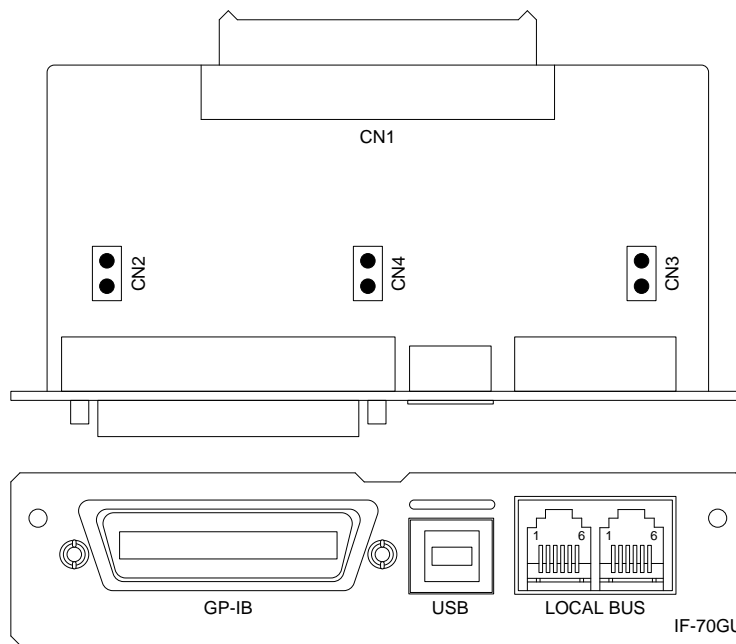

Connector name	Function
GP-IB	Connects to the GP-IB controller of PC.
USB	Connects to the USB port of a PC or USB hub.
LOCAL BUS	Connects to the local bus. A dedicated modular cable is required to connect to the local bus.
CN1	Connects to the power unit. For details about how to connect to the power unit, see the IF-70GU instruction manual.
CN2	Short-circuits the frame GND and signal GND of GP-IB and USB. CN 2 is used to eliminate ground loops in noisy environments.
CN3	Connects to the terminator of the local bus and the internal bus when the circuit is closed. In the local bus, a terminator is required for the power supply units at each end of the signal line or for stand alone.
CN4	Switches operation between the GP-IB and USB. The GP-IB operates when the circuit is closed, and the USB operates when the circuit is open.

11-1-2. IF-71LU

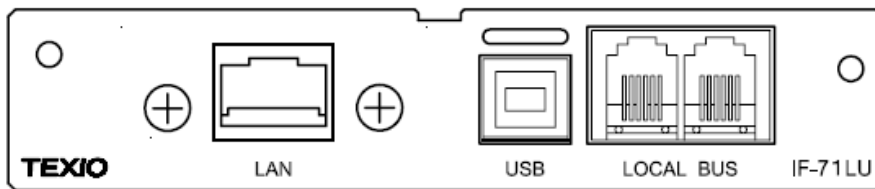
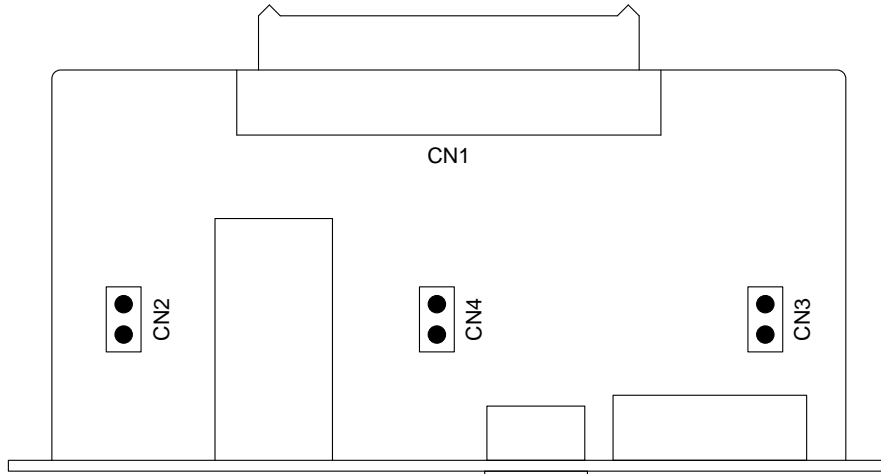

Connector name	Function
LAN	Connects to a controller, such as the controller of a LAN switching hub.
USB	Connects to the USB port of a PC or USB hub.
LOCAL BUS	Connects to the local bus. A dedicated modular cable is required to connect to the local bus.
CN1	Connects to the power unit. For details about how to connect to the power unit, see the IF-71LU instruction manual.
CN2	Short-circuits the frame GND and signal GND of the LAN and USB. CN 2 is used to eliminate ground loops in noisy environments.
CN3	Connects to the terminator of the local bus and the internal bus when the circuit is closed. In the local bus, a terminator is required for the power supply units at each end of the signal line or for stand alone.
CN4	Switches between LAN and USB operation. The LAN operates when the circuit is closed, while the USB operates when the circuit is open.

11-1-3. IF-71RS

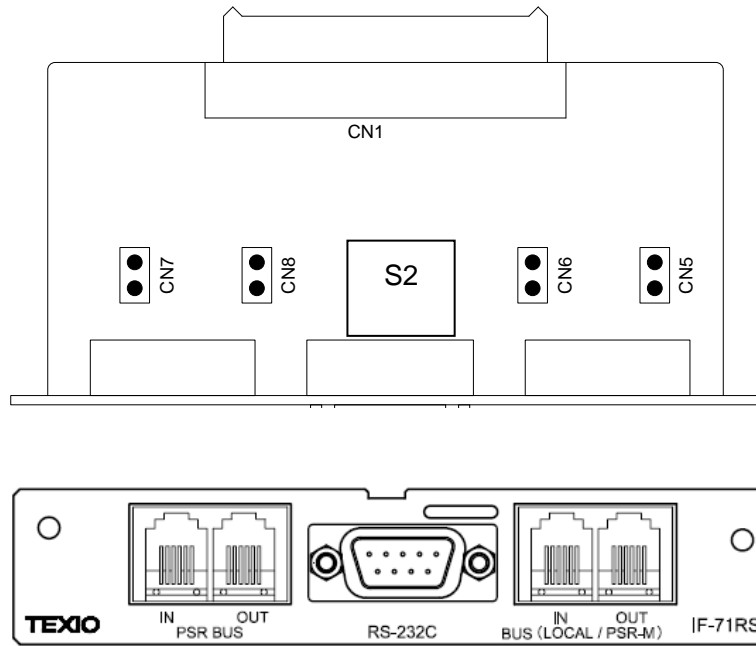

Connector name	Function
PSR BUS	Used together with a dedicated modular cable to connect to a PSR series power supply unit.
RS-232C	Used together with a crossover cable to connect to the RS-232C of a PC.
LOCAL/PSR-M BUS	Used together with a dedicated modular cable to connect to the local bus. Specifying the appropriate settings enables it to be used as a unit compatible with PSR-M series power supply units.
CN1	Connects to the power unit. For details about how to connect to the power unit, see the IF-71RS instruction manual.
CN5	Connects to the terminator of the local bus and the internal bus when the circuit is closed. In the local bus, a terminator is required for the power supply units at each end of the signal line or for stand alone.
CN6	Switches over to local bus mode. CN6 provides compatibility with PSR-M units when the circuit is closed, and compatibility with the local bus of PDS-A when the circuit is open.
CN7	Switches over to RS-232C mode. CN7 provides compatibility with PSR units when the circuit is open, and compatibility with the local bus of PDS-A when the circuit is closed.
CN8	Short-circuits the frame GND and signal GND of RS-232C.
S2	Switches the RS-232C communication mode. Standard communication mode. "1" to "6" indicate "ON", "7" and "8" indicate "OFF". (Standard commands are used to perform communication.) PDS communication mode. "1" to "6" indicate "OFF", "7" and "8" indicate "ON". (Commands issued by the PDS power supply unit are used to perform communication.)

11-1-4. Cable and connector settings

The circuits for all the connectors are open by default.

Adjust the connector settings according to the type of control used.

(1) When a GP-IB is used:

A commercially available GP-IB cable can be used for the GP-IB connection of IF-70GU. (our part No. CB-2420P)

When GP-IB is used, the settings of the IF-70GU connectors are as follows:

Connector	Circuit
CN2	Closed
CN3	Closed
CN4	Closed

(2) When a USB is used:

Use a commercially available USB full speed cable for the USB connection.

When a USB is used, the settings of the IF-71LU connectors are as follows:

Connector	Circuit
CN2	Closed
CN3	Closed
CN4	Open

(?) When a LAN is used

Use a commercially available LAN cable (category 5E or higher) to connect IF-71LU to a LAN.

When a LAN is used, the settings of the IF-71LU connectors are as follows:

Connector	Circuit
CN2	Closed
CN3	Closed
CN4	Closed

(3) When a RS-232C is used

Use commercially available crossover cables or interlink cables for the RS-232C connection.

The wiring of RS-232C cable is as follows:

Three lines are used: the sending, receiving, and grounding lines.

The hardware flow-control line is not used.

The wiring of the other terminals is disregarded.

PC / Sequencer				IF-71RS		
D-Sub9 pin Female	2	RxD	↔	TxD	3	D-Sub9 pin Female
	3	TxD	↔	RxD	2	
	5	GND	↔	GND	5	

When a RS-232C is used, the settings of the IF-71RS connectors are as follows:

Connector	Circuit
CN5	Closed
CN6	Open
CN7	Closed
CN8	Open

(4) When local bus is used:

Use a straight 6-pin modular cable for the local bus connection.

This cable is a twisted pair cable with D+ and D- signals. Four different lengths are available.

Connector	Signal
PIN1	Case GND
PIN3	D+
PIN4	Signal GND
PIN5	D-

Cable art No.	Cable length
CB-0603S	0.3m
CB-0615S	1.5m
CB-0630S	3m
CB-06100S	10m

11-1-5. Address settings

If the IF-70GU, IF-71LU, or IF-71RS is mounted on the PDS-A power supply unit, the address setting will appear on the menu when the unit is turned on and started by pressing and holding the MENU key.

There are two types of addresses for PDS-A units: a system address (SYAD) and a PC address (PCAD).

- The system address is used to identify the PDS-A power supply unit when the unit is connected via a local bus. This address is specified by the IF-70GU, IF-71LU or IF-71RS. The system address must be specified as Address 1 of the unit which is connected to the controller (PC or sequencer).

Communication with the controller is only possible if the system address has been specified as Address 1.

If you assign multiple system addresses to a local bus, make sure to assign a different value for each address. If you assign the same value multiple times, communication errors might occur.

- The PC address is used to identify the PDS-A unit when the unit is directly connected to the PC.

The respective use of the PC address varies according to the connection method.

Communication method	Use of PC address
GP-IB	GP-IB address.
USB	Device address for the USB device driver.
LAN	Used to identify the unit by commands when the IP address is automatically allocated.
RS-232C	Not available.

* When a USB is used, the PC address acts as a device address. In this case, do not connect PDS-A power supply units that have the same address.

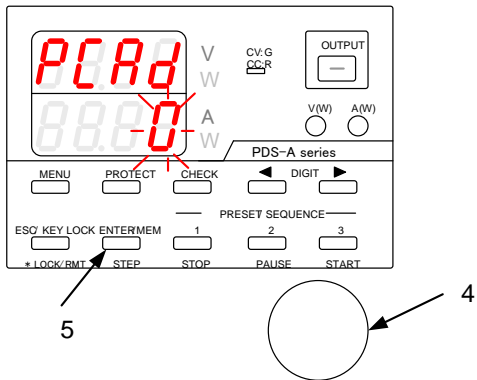
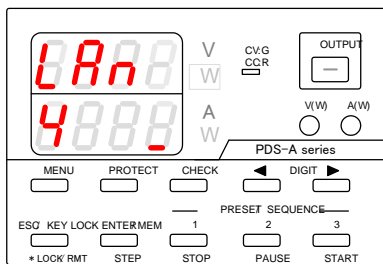
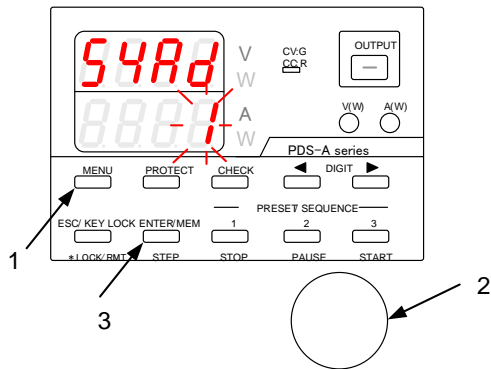

Operation procedure

1. Turn on the power switch while pressing and holding the MENU key.
Release the MENU key when the panel is lit.
"SYAd" (system address) is then displayed in the voltage indicator.

2. Turn the rotary encoder to change the value.

If the PDS-A unit is connected to a PC, specify "1" as the system address. If the unit is connected to local bus, a value from "2" to "31" can be specified as the address.

3. After specifying the value, press the ENTER key.

If the system address is set to "1" and pressing the ENTER key, "PCAd" (PC address) is then displayed in the voltage indicator.

4. Turn the rotary encoder to change the value.
The value range is from "0" to "31".

5. Press the ENTER key to specify "PCAd".
When you are finished, press the ESC key to exit.
After the address has been set, the unit reboots.

11-1-6. Checking the mode and address settings of the interface card

Check the card type of the option card mounted on the unit and the card's settings.

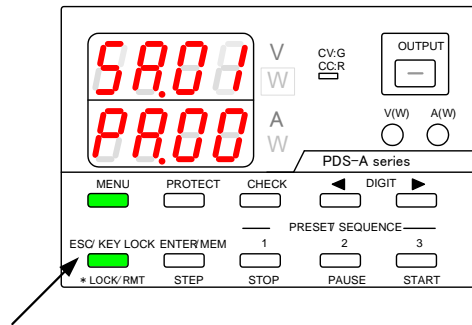
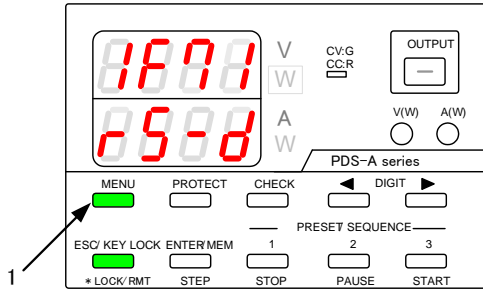

Operation procedure

1. Repeatedly press the MENU key until "IF--" is displayed in the voltage indicator.
2. If the mounted interface card is the IF-70GU, IF-71LU, or IF-71RS (all of which allow the unit to be controlled remotely), the system address and PC address can be displayed by pressing the MENU key while "IF--" is displayed.

Screen Display of IF Card Information

IF card type	Mode	Display	IF card type	Mode	Display
IF-70GU	GP-IB	1F70 G0-G	IF-71RS	PSA	1F77 r5-R
	USB	1F70 G0-U		PDS	1F77 r5-d
IF-71LU	LAN	1F77 L0-L		PSR-M	1F77 r5-R
	USB	1F77 L0-U		PSR	1F77 r5-r
Analog card	None	1F-- --Rn	No card	None	1F-- ----

Display of the system address and PC address

The system address is the last two digits (following "SR.") displayed in the voltage indicator.

The PC address is the last two digits (following "PA.") displayed in the current indicator.

When using the IF-70GU or IF-71LU, if the system address is "1", the value of the PC address is displayed as a number.

In other cases, "PC.-" is displayed for the PC address.

11-1-7. GP-IB connection

The following chart shows the wiring for when the GP-1B is used to connect IF-70GU to a PC:

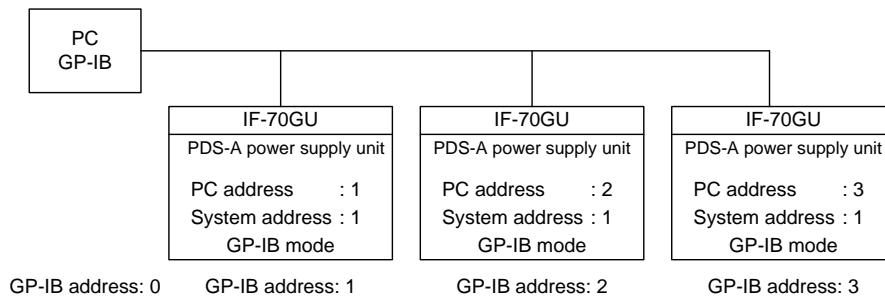

- Operation of the GP-IB has been verified by using a GP-IB board manufactured by National Instruments. A sample program is available on our website. No operation problems occurred when using a GP-IB that satisfies the IEEE488 specifications. For details about programming GP-IB, see the instruction manual for the interface being used, or the manual for the sample program.
- LF (0x0A) and EOI are applied to set the delimiter. Be sure to output the delimiter after outputting the commands and parameters. Note that CR (0x0D) will be ignored. Be careful not to enter the wrong letters.
- At least half of the devices to which the GP-IB is connected must be powered on. Turn on the power of all the devices.
- Two addresses are required for the address setting of the PDS-A power supply unit: the system address and PC address. Make sure to specify "1" as the system address for the PDS-A unit connected to the PC.
- The GP-IB complies with the IEEE488-1978 specifications. Interface actions are SH1, AH1, T6, TE0, L3, LE0, SR0, RL1, PP0, DC0, DT0, and C0.

11-1-8. USB connection

The following chart shows the wiring for when the USB is used to connect IF-71LU to a PC:

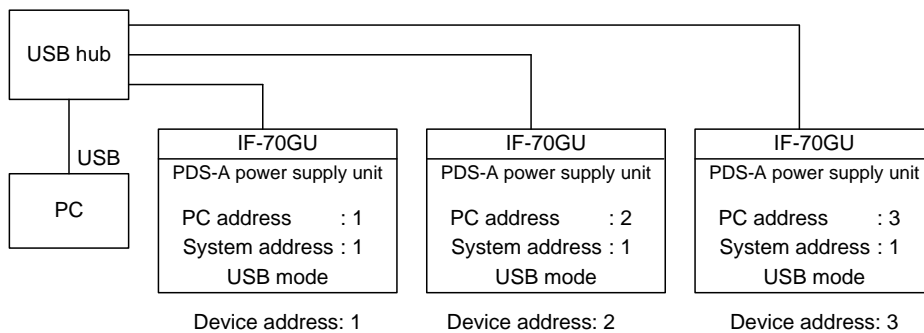

- PDS-A units support USB2.0 full speed. The USB ports on a PC can be used.
- The dedicated device driver and API provided by us need to be installed and configured on your PC. Visit our website to download the device driver and API.
 - ◆ For details about the required PC environment and operation procedures, see the API instruction manual. It does not support USBTMC.
- This device driver does not support the suspension or sleep modes from the PC side.
- The environment in which a USB is used is extremely susceptible to external noise, which may cause the USB to malfunction. Install the USB in manner that minimizes the effect of noise on the communication pathway, and make sure to implement countermeasures against noise.
- When a PDS-A series unit is used with a USB, two addresses are required for the address setting: the system address and PC address. Make sure to specify "1" as the system address for the PDS-A unit connected to the PC.

11-1-9. RS-232C connection

The following chart shows the wiring for when the RS-232C is used to connect IF-71RS to a PC or sequencer. The RS-232C is one-to-one connection. One serial port is required for each of the units that are directly connected.

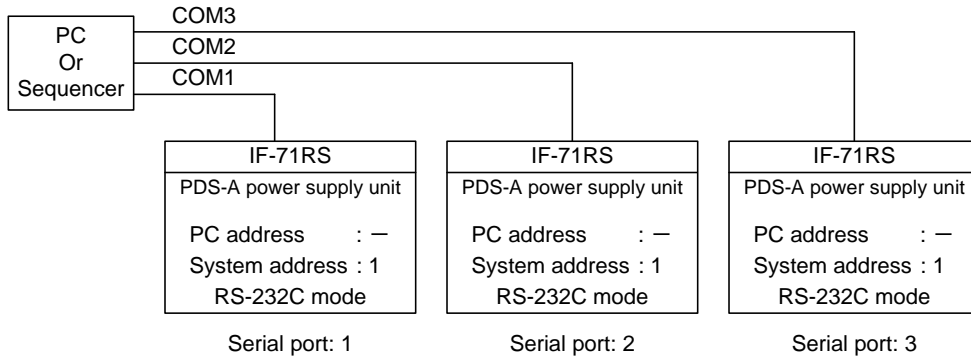

- RS-232C communication conditions
 - PS-A/PSR setting: Half duplex at 9600 bps. Data length: 7 bits. Stop bit: 1. Parity: Even number.
 - PDS setting: Full duplex at a specified rate. Data length: 8 bits. Stop bit: 1. Parity: None.
- If the PS-A/PSR setting is specified in RS-232C communication, when a character string is sent from the PC to the power supply unit, the unit sends back the same string (echo back). To read out the response, it is necessary to program the delimiter (LF:0x0A) to separate the commands from the actual response signals.
- If the PDS-A setting is specified, the string is not echoed back. Receive processing is only required when response data exists.
- Flow control is not performed in the RS-232C communication.
 - If the PS-A/PSR setting is specified, collection errors are detected by comparing the sent command to the character string which is echo backed.
 - If the PDS-A setting is specified, communication errors cannot be detected because character strings are not echoed back.
- The PC address is not applied when the RS-232C is used to control the unit.

11-1-10. LAN connection

The following figure shows the wiring for connecting the IF-71LU to the PC via a LAN.

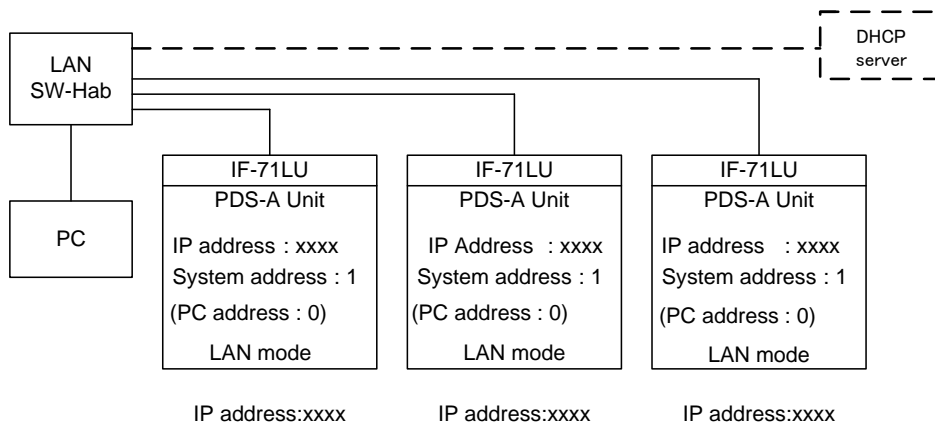

- The LAN uses an XPort (manufactured by Lantronix) that supports Ethernet (IEEE 802.3) communication. A RJ-45 connector (10BASE-T or 100BASE-TX) is used to connect the Ethernet interface.
- The following IP addresses are supported: fixed IP, DHCP, and Auto IP.
- TCP/IP for socket control, and COM port redirector for communication control.
- The delimiter for sending and receiving commands is LF (0x0A). Make sure to output the delimiter at the end of output.
- There are two addresses specified for the PDS-A power supply unit: system address and PC address. The setting of system address is "1".

The PC address is used to identify the device when DHCP or Auto IP is selected. When the IP address is a fixed IP, there is no need to configure the PC address.

- For details about configuring an automatic IP address or COM redirector, see the corresponding section in the operation manual. You can download the operation manual from our company's website.
- For details about IP address setting, see the 6-4-4. Clearing the setting data for IF-71LU IP address setting.

11-1-11. Local bus connection

In a local bus connection, the master PDS-A power supply unit used to communicate with the PC can control up to 30 slave PDS-A power supply units connected (in cascade arrangement) to the master unit via a dedicated modular cable.

The use of RS-485 signals in a local bus connection makes it possible to extend the distance between devices. However, in order to ensure stable control, the lengths of the cables used should be kept as short as possible.

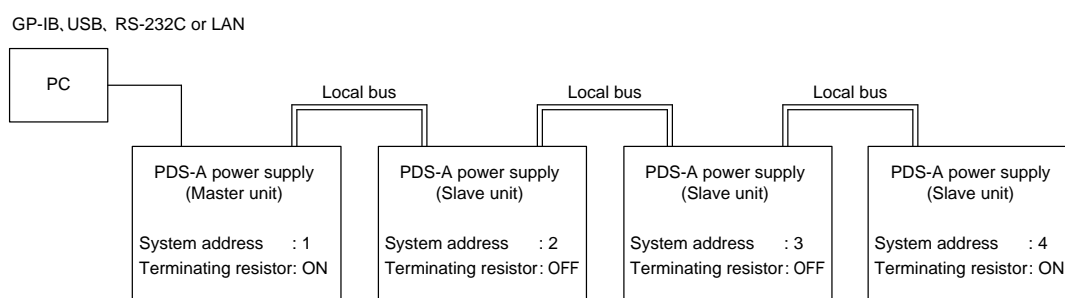

When specifying slave units, use the ADRS command to specify the system address number.

For the interface setting of the slave unit IF-70GU, the available values are USB or GP-IB.

An IF-71RS configured for RS-232C communication can be used as an interface for slave units.

Only the terminators at each end of the local bus should be on. The other terminators should be off.

In the figure above, the terminators for system addresses 1 and 4 are set to "ON". The rest are set to "OFF".

IF card	Setting	Master unit	Intermediate slave unit	End of slave unit
IF-70GU	System address	1	2 to 31	
	PC address	0 to 31	Cannot be specified	
	IF card mode setting	USB or GPIB	Not used. USB or GPIB can be specified.	
	IF card terminator	ON	OFF	ON
IF-71RS	System address	1	2 to 31	
	PC address	Cannot be specified	Cannot be specified	
	IF card mode setting	RS-232C	RS-232C	
	IF card terminator	ON	OFF	OFF
IF-71LU	System address	1	2 to 31	
	PC address	0 to 31	Cannot be specified	
	IF card mode setting	USB or LAN	Not used. USB or LAN can be specified.	
	IF card terminator	ON	OFF	ON

11-2. Communication Control Commands

11-2-1. Communication commands table

If a digital IF board has been installed in the PDS-A supply unit, the commands are as follows:

Category	Item	Command Name	Setting	Query	Page	
Output setting	Voltage setting	VOLT	Available	Available	86	
	Current setting	AMP	Available	Available	86	
	Modifying the set value of the protective function	OVP	Available	Available	86	
	Modifying the set value of the protective function	UVP	Available	Available	86	
	Modifying the set value of the protective function	OCP	Available	Available	86	
	Output function	OUTPUT	Available	Available	87	
	Status request	XSTATUS	-	Available	87	
Function setting	Saving and recalling the set voltage and current in PRESET	PRESET	Available	Available	87	
	Saving and recalling the set voltage and current in PRESET	SETPRE	Available	-	87	
	Saving and recalling the set voltage and current in PRESET	PREVOLT	Available	Available	88	
	Saving and recalling the set voltage and current in PRESET	PREAMP	Available	Available	88	
	Displaying the power in the voltage & current indicators	MONDSP	Available	Available	88	
	Output setting when the power is turned on	DSPY	Available	Available	88	
	Switching between the set voltage & current display and the output voltage & current display	CHECK	Available	Available	89	
	Setting CC priority mode	CCPRIO	Available	Available	89	
	Setting the output off timer	OFFTM	Available	Available	89	
	Setting the automatic cancellation time for the setting menu display	ESC	Available	Available	89	
	Setting the main relay	POWER	Available	Available	90	
	Key lock / local function	GTL	Available	-	90	
	Setting local lock out	LLO	Available	-	90	
	Setting the sequence operation	PONSEQ	Available	Available	90	
	Recalling preset values when the power is turned on	PONPRE	Available	Available	90	
	Output setting when the power is turned on	PONOUT	Available	Available	91	
	Main relay setting when the power is turned on	PONPOW	Available	Available	91	
	Notification setting 1	MASK	Available	Available	91	
	Notification setting 2	AMASK	Available	Available	92	
	Notification setting 3	SMASK	Available	Available	92	
	Alarm	ALM	-	Available	92	
	Alarm	EXIT_ALM	Available	-	92	
	Sequence	Sequence operation	SCLR	Available	-	92
Sequence operation		XSWRITE	Available	-	93	
Sequence operation		XSREAD	-	Available	94	
Sequence operation		SSADR	Available	Available	94	
Sequence operation		SEADR	Available	Available	94	
Sequence operation		SMODE	Available	Available	95	
Sequence operation		SCYCLE	Available	Available	95	
Sequence operation		CHGSEQ	Available	-	95	
Sequence operation		CHGNORM	Available	-	95	
Automatic execution of the sequence program		SSTART	Available	Available	95	
Pausing and restarting the sequence program		SSTOP	Available	Available	95	
Pausing and restarting the sequence program		SPAUSE	Available	Available	96	
Manual execution of the sequence program		SSTEP	Available	Available	96	
Reading out the sequence execution status		SRUN	-	Available	96	
System		Reset	*RST	Available	-	96
		Reset	RESET	Available	-	96
	Reading out status byte	*STB	-	Available	97	
	Reading out product information	*IDN	-	Available	97	
	Model and specifications query	MODEL	-	Available	97	
	Designating local bus device	ADRS	Available	Available	98	
	Unit product name query	UNIT?	-	Available	98	
	Query-dedicated PC address for device identification when controlled by a LAN	LPCAD?	-	Available	98	

11-2-2. Automatic message output

The PDS-A series unit is equipped with a function that outputs response messages independently of communication commands when a status change occurs. Output response messages can be selected by using the notification setting commands. As parameters, the response message contains the system address of the unit on which a status change has occurred, and the information about the status change. The table below describes the different status changes and response messages that are output.

◆ For details about commands to enable/disable response messages, see the following sections:

“11-3-25. Notification setting 1 (MASK)”

“11-3-26. Notification setting 2 (AMASK)”

“11-3-27. Notification setting 3 (SMASK)”

All messages are disabled by default when the power is turned on.

This is normally used for the message receiving stand-by function in RS-232C communication or other communication modes.

Status Change	Response Message	Parameter 1	Parameter 2
Alarm occurrence	ALARM	System address	1: Occurrence of hardware alarm 2: Occurrence of under-voltage protection 3: Occurrence of over-voltage protection 4: Occurrence of over-current protection 5: Occurrence of other alarms
Error occurrence	ERROR	System address	1: Occurrence of command error 2: Occurrence of parameter error 3: Occurrence of execution error 4: Occurrence of warning
CV/CC mode change	SRCC	System address	0: CC mode → CV mode 1: CV mode → CC mode
Sequence end	END	System address	1: Completion
Sequence pause	PAUSE	System address	1: Completion

11-2-3. Command format

Communication commands consist of general alphanumeric characters and symbols, and a header that is the abbreviation of a function. Each header is followed by a space and a parameter. No distinction is made between capital and lowercase letters, but all letters are converted to capital letters for the sake of processing.

<Example>	Voltage setting			
	VOLT	_____	5.12	LF
	Header	Space	Parameter	Delimiter

Parameters are specified with an integer number, decimal number, and character string. Decimal places are rounded off according to the actual setting resolution. If there are several parameters, they should be marked off with a comma (.). If a parameter that should be specified with an integer number is specified with a decimal, an error occurs. Make sure to correctly specify parameters.

Query commands feature a question mark (?) immediately after the function name header. Do not insert a space between the question mark and header, otherwise an error will occur.

The response to a query command will be the command and its parameter.

<Example>	Voltage setting query			
	VOLT ?	LF		
	Header	Delimiter		
<Example>	Voltage setting response			
	VOLT	_____	5.12	LF
	Header	Space	Parameter	Delimiter

When querying an item that has a parameter, insert a space and the items' parameter after the question mark (?)

For commands that require a parameter, normal operation cannot be done if the parameter is omitted or incomplete. Make sure to input a complete parameter. In addition, inserting a space before and/or after a command may impede normal operation. Do not insert unnecessary spaces.

<Example> Voltage setting query of PRESET 1				
	PREVOLT ?	___	1	LF
	Header	Space	Parameter	Delimiter
<Example> Voltage setting response of PRESET 1				
	PREVOLT	___	<u>1.5.12</u>	LF
	Header	Space	Parameter	Delimiter

When communicating from a PC to a slave unit on the local bus, the local bus designation command (ADRS) should be used to designate a system address for the slave unit.

The default system address is "1", which is the setting for the master unit.

11-3. Commands

11-3-1. Voltage setting (VOLT)

This command sets or queries the output voltage.

Setting	VOLT x1	Sets the output voltage.
Application example	VOLT 5.00	Sets the output voltage to 5.00V.
Query	VOLT?	Queries the output voltage setting.
Response example	VOLT 5.00	Indicates the set output voltage is 5.00V.
Remarks	"x1" is a decimal or integer number. Digits less than the setting resolution are rounded off. ◆ For details about the setting range, see "Appendix C. SPECIFICATIONS" . If the set value exceeds the range, the maximum value will be given.	

11-3-2. Current setting (AMP)

This command sets or queries the output current.

Setting	AMP x1	Sets the output current.
Application example	AMP 5.00	Sets current to 5.00A.
Query	AMP?	Queries the output current setting.
Response example	AMP 5.00	Indicates the set output current is 5.00A.
Remarks	"x1" is a decimal or integer number. Digits less than the setting resolution are rounded off. ◆ For details about the setting range, see "Appendix C. SPECIFICATIONS" . If the set value exceeds the range, the maximum value will be given.	

11-3-3. OVP setting (OVP)

This command sets or queries the OVP (over-voltage protection) value.

Setting	OVP x1	Sets the OVP.
Application example	OVP 5.00	Sets the OVP value to 5.00V.
Query	OVP?	Queries the OVP value.
Response example	OVP 5.00	Indicates the set OVP value is 5.00V.
Remarks	"x1" is a decimal or integer number. Digits less than the setting resolution are rounded off. ◆ For details about the setting range, see "Appendix C. SPECIFICATIONS" . If the set value exceeds the range, the maximum value will be given.	

11-3-4. UVP setting (UVP)

This command sets or queries the UVP (under-voltage protection) value.

Setting	UVP x1	Sets the UVP value.
Application example	UVP 5.00	Sets the UVP value to 5.00V.
Query	UVP?	Queries the UVP value.
Response example	UVP 5.00	Indicates the set UVP value is 5.00V.
Remarks	"x1" is a decimal or integer number. Digits less than the setting resolution are rounded off. ◆ For details about the setting range, see "Appendix C. SPECIFICATIONS" . If the set value exceeds the range, the maximum value will be given.	

11-3-5. OCP setting (OCP)

This command sets or queries the OCP (over-current protection) value.

Setting	OCP x1	Sets the OCP value.
Application example	OCP 5.00	Sets the OCP value to 5.00A.
Query	OCP?	Queries the OCP value
Response example	OCP 5.00	Indicates the set OCP value is 5.00A.
Remarks	"x1" is a decimal or integer number. Digits less than the setting resolution are rounded off. ◆ For details about the setting range, see "Appendix C. SPECIFICATIONS" . If the set value exceeds the range, the maximum value will be given.	

11-3-6. Output setting (OUTPUT)

This command sets and queries the output on/off setting.

Setting	OUTPUT x1	x1: Output status 0: Output off 1: Output on
Application example	OUTPUT 1	Turns the output on.
Query	OUTPUT?	Queries the output setting.
Response example	OUTPUT 0	Indicates the output is off.
Remarks		

11-3-7. Status query (XSTATUS)

This command queries the output status and set values.

Query	XSTATUS?	Queries the output status.
Response form	XSTATUS x1,x2,x3,x4,x5,x6,x7,x8,x9 x1: Output status 0: Output off; 1: Output on; x2: CV/CC status 0: CV mode; 1: CC mode; 2: Other/output off x3: Output voltage x4: Output current x5: Set voltage x6: Set current x7: Set OVP (over-voltage protection) value x8: Set UVP (under-voltage protection) value x9: Set OCP (over-current protection) value	
Response example	XSTATUS 1,0,5.15,3.10,5.15,2.10,10.2,-0.5,4.0 Output on, CV mode, Output 5.15V/3.10A, Set values: 5.15V/2.10A, OVP:10.2V/UVP:-0.5V/OCP:4.0A	
Remarks		

11-3-8. Recalling preset settings (PRESET)

This command recalls preset settings and queries the preset status.

Setting	PRESET x1	x1: PRESET No. (1, 2, or 3)
Application example	PRESET 1	Recalls PRESET 1.
Query	PRESET?	Queries the preset status.
Response example	PRESET 0	0: Not in PRESET. 1: PRESET 1 is recalled. 2: PRESET 2 is recalled. 3: PRESET 3 is recalled.
Remarks	If a preset setting is recalled and then the voltage or current setting is modified, the preset setting is lost.	

11-3-9. Saving preset settings (SETPRE)

This command saves the set voltage and current values in preset memory.

Setting	SETPRE x1	x1: PRESET No. (1, 2, or 3)
Application example	SETPRE 1	Saves the set current and voltage values in PRESET 1.
Remarks	Queries cannot be made.	

11-3-10. Preset voltage setting (PREVOLT)

This command saves the set voltage directly to the preset memory, and queries the preset status.

Setting	PREVOLT x1,x2	x1: PRESET No. (1, 2, or 3) x2: Set voltage value
Application example	PREVOLT 1,3.15	Saves 3.15V as the set voltage value in PRESET 1.
Query	PREVOLT? x1	x1: PRESET No. (1, 2, or 3)
Response form	PREVOLT x1,x2	x1: PRESET No. (1, 2, or 3) x2: Set voltage value
Response example	PREVOLT 1,3.15	Indicates 3.15V is the set voltage value saved in PRESET 1.
Remarks	◆ For details about the setting range, see "Appendix C. SPECIFICATIONS".	

11-3-11. Preset current setting (PREAMP)

This command saves the set current directly to the preset memory, and queries the preset status.

Setting	PREAMP x1,x2	x1: PRESET No. (1, 2, or 3) x2: Set current value
Application example	PREAMP 1,3.15	Saves 3.15A as the set current value for PRESET 1.
Query	PREAMP? x1	x1: PRESET No. (1, 2, or 3)
Response form	PREAMP x1,x2	x1: PRESET No. (1, 2, or 3) x2: Set current value
Response example	PREAMP 1,3.15	Indicates 3.15A is the set current value saved in PRESET 1.
Remarks	◆ For details about the setting range, see "Appendix C. SPECIFICATIONS".	

11-3-12. Power monitor display setting(MONDSP)

This command changes the power monitor display.

Setting	MONDSP x1	x1: Monitor display setting 0: Voltage & current display 1: Voltage & power display 2: Power & current display
Application example	MONDSP 1	Sets the voltage & power display.
Query	MONDSP?	Queries the monitor display status.
Response example	MONDSP 0	0: Displays the voltage & current. 1: Displays the voltage & power. 2: Displays the power & current.
Remarks		

11-3-13. Power-off display setting(DSPY)

This command sets the display for when the output is off.

Setting	DSPY x1	x1: Display change setting 0: Only set values are displayed while the output is off. 1: Display can be switched between the set values and output values while the output is off.
Application example	DSPY 1	Specify whether the display can be switched between the set values and output values while the output is off.
Query	DSPY?	Queries the display setting.
Response example	DSPY 0	0: Only set values are displayed while the output is off. 1: Indicates the display can be switched between the set/output values while the output is off.
Remarks		

11-3-14. Monitor display switching (CHECK)

This command switches between the set/output values of the voltage & current monitor display.

Setting	CHECK x1	x1: Display change setting 0: Output value display 1: Set value display
Application example	CHECK 1	Sets the set value display.
Query	CHECK?	Queries the status.
Response example	CHECK 0	0: Displays the output values. 1: Displays the set values.
Remarks	If display switching has been disabled for when the output is off, the display cannot be changed.	

11-3-15. CC priority mode setting when the output is turned on (CCPRIO)

This command sets the CC (constant-current) priority mode for when the output is turned on.

Setting	CCPRIO x1	x1: CC priority mode setting for when the output is turned on. 0: CV priority mode 1: CC priority mode
Application example	CCPRIO 1	Sets CC priority mode.
Query	CCPRIO?	Queries the status.
Response example	CCPRIO 0	0: CV priority mode. 1: CC priority mode.
Remarks		

11-3-16. Output off timer setting (OFFTM)

This command sets the off timer and queries the off timer setting.

Setting	OFFTM x1/x2	Sets the off timer. The time is set in hour/min.
Application example	OFFTM 8/30	Sets 8 hours 30 min for the off timer.
Query	OFFTM?	Queries the set time of the off timer.
Response example	OFFTM 8/30	Indicates the set time of the off timer is 8 hours 30 min.
Remarks	The settable hour range is from 0 to 10000 hours, and the settable minute range is from 0 to 59 minutes. The set time of the off timer cannot be 0 hours 0 min.	

11-3-17. Automatic cancellation time setting for the setting menu display (ESC)

This command sets and queries the automatic cancellation time.

Setting	ESC x1	x1: Sets the automatic cancellation time; integer from 1 to 10.
Application example	ESC 5	Sets 5 min as the automatic cancellation time for the display.
Query	ESC?	Queries the automatic cancellation time for the display.
Response example	ESC 5	Indicates 5 min has been set as the automatic cancellation time for the display.
Remarks		

11-3-18. Main relay setting (POWER)

This command sets the main relay and queries the main relay status.

Setting	POWER x1	x1: Sets the main relay operation. 0: Turns the main relay off. 1: Turns the main relay on.
Application example	POWER 1	Turns the main relay on.
Query	POWER?	Queries the on/off status of the main relay.
Response example	POWER 1	1: Indicates the main relay is on. 0: Indicates the main relay is off.
Remarks	See "9-2-7. Main relay ON/OFF operation"	

11-3-19. Unlocking (GTL)

This command cancels the panel keylock.

Setting	GTL	No parameter.
Application example	GTL	Enables panel operation for changing from remote control to local control.
Remarks		

11-3-20. Local lock out setting (LLO)

This command disables panel unlocking.

Setting	LLO	No parameter.
Application example	LLO	Disables use of the ESC for remotely unlocking the operation panel. Once local lock out is set, it cannot be cancelled until the power is turned off.
Remarks		

11-3-21. Sequence operation setting when the power is turned on (PONSEQ)

This command sets and queries the sequence operation for when the power is turned on.

Setting	PONSEQ x1	x1: Specifies whether to perform a sequence operation when the power is turned on. 0: Specifies normal operation. 1: Specifies sequence operation.
Application example	PONSEQ 1	Specifies a sequence operation to start from the next time the power is turned on.
Query	PONSEQ?	Queries the sequence operation setting for when the power is turned on.
Response example	PONSEQ 1	Indicates that a sequence operation has been selected.
Remarks		

11-3-22. Preset setting when the power is turned on (PONPRE)

This command sets and queries the preset recall operation for when the power is turned on.

Setting	PONPRE x1	x1: Specifies whether to perform a recall operation when the power is turned on. 0: Set values are for when the power was last turned off. 1: Recalls PRESET 1. 2: Recalls PRESET 2. 3: Recalls PRESET 3.
Application example	PONPRE 1	Recalls PRESET 1 when the power is turned on.
Query	PONPRE?	Queries the preset recall setting for when the power is turned on.
Response example	PONPRE 1	Indicates PRESET 1 is recalled when the power is turned on.
Remarks		

11-3-23 Output setting when the power is turned on (PONOUT)

This command sets and queries the output setting for when the power is turned on.

Setting	PONOUT x1	x1: Specifies whether to turn on the output when the power is turned on. 0: Output is not turned on. 1: Output is turned on.
Application example	PONOUT 1	Turns the output on when the power is turned on.
Query	PONOUT?	Queries the output on setting for when the power is turned on.
Response example	PONOUT 1	Indicates the output is turned on when the power is turned on.
Remarks		

11-3-24. Main relay setting when the power is turned on (PONPOW)

This command sets and queries the main relay setting for when the power is turned on.

Setting	PONPOW x1	x1: Specifies whether to turn on the main relay when the power is turned on. 0: Main relay is not turned on. 1: Main relay is turned on.
Application example	PONPOW 1	Turns on the main relay when the power is turned on.
Query	PONPOW?	Queries the main relay setting for when the power is turned on.
Response example	PONPOW 1	Indicates the main relay is turned on when the power is turned on.
Remarks		See "9-2-7. Main relay ON/OFF operation"

11-3-25. Notification setting 1 (MASK)

This command sets and queries the character string issued for alarm notification 1.

Setting	MASK x1	x1: Uses an 8 digit combination of 0 and 1 to enable/disable alarm notification 1. MASK xxxxxx1 : Enable(1)/disable(0) hardware alarm notification. MASK xxxxxx1x : Enable(1)/disable(0) OVP occurrence notification. MASK xxxxx1xx : Enable(1)/disable(0) UVP occurrence notification. MASK xxxx1xxx : Enable(1)/disable(0) CV/CC mode change notification. MASK xxx1xxxx : Enable(1)/disable(0) command error notification. MASK xx1xxxxx : Enable(1)/disable(0) parameter error notification. MASK x1xxxxxx : Enable(1)/disable(0) execution error notification. MASK 1xxxxxxx : Enable(1)/disable(0) warning notification.																		
Application example	MASK 00001000	Sends the CV/CC mode change notification.																		
Query	MASK?	Queries the alarm notification setting.																		
Response example	MASK 00001000	Alarm notification is issued when CV/CC mode is changed.																		
Remarks	<p>The message issued contains a header to identify the unit on the local bus, followed by the system address (%1) of the unit on which the alarm occurred, and the alarm type. The default setting is 00000000.</p> <table> <tr> <td>Hardware alarm</td> <td>ALARM %1,1</td> </tr> <tr> <td>OVP occurrence</td> <td>ALARM %1,3</td> </tr> <tr> <td>UVP occurrence</td> <td>ALARM %1,2</td> </tr> <tr> <td>CV mode → CC mode</td> <td>SRCC %1,0</td> </tr> <tr> <td>CC mode → CV mode</td> <td>SRCC %1,1</td> </tr> <tr> <td>Command error</td> <td>ERROR %1,1</td> </tr> <tr> <td>Parameter error</td> <td>ERROR %1,2</td> </tr> <tr> <td>Execution error</td> <td>ERROR %1,3</td> </tr> <tr> <td>Warning error</td> <td>ERROR %1,4</td> </tr> </table>		Hardware alarm	ALARM %1,1	OVP occurrence	ALARM %1,3	UVP occurrence	ALARM %1,2	CV mode → CC mode	SRCC %1,0	CC mode → CV mode	SRCC %1,1	Command error	ERROR %1,1	Parameter error	ERROR %1,2	Execution error	ERROR %1,3	Warning error	ERROR %1,4
Hardware alarm	ALARM %1,1																			
OVP occurrence	ALARM %1,3																			
UVP occurrence	ALARM %1,2																			
CV mode → CC mode	SRCC %1,0																			
CC mode → CV mode	SRCC %1,1																			
Command error	ERROR %1,1																			
Parameter error	ERROR %1,2																			
Execution error	ERROR %1,3																			
Warning error	ERROR %1,4																			

11-3-26. Notification setting 2 (AMASK)

This command sets and queries the character string issued for alarm notification 2.

Setting	AMASK x1	x1: Uses an 8 digit combination of 0 and 1 to enable/disable alarm notification 2.
	AMASK 000000x1 :	Enable(1)/disable(0) other alarm notification.
	AMASK 0000001x :	Enable(1)/disable(0) OCP occurrence notification.
Application example	AMASK 00000001	Sends an alarm notification when OCP occurs.
Query	AMASK?	Queries the alarm notification 2 setting.
Response example	AMASK 00000001	Issues an alarm notification when OCP occurs.
Remarks	<p>The message issued contains a header to identify the unit on the local bus, followed by the system address (%1) of the unit on which the alarm occurred, and the alarm type.</p> <p>The default setting is 00000000.</p> <p>Other alarm ALARM %1,5</p> <p>OCP occurrence ALARM %1,4</p>	

11-3-27. Notification setting 3 (SMASK)

This command sets and queries the character string issued for sequence status notification.

Setting	SMASK x1	x1: Uses an 8 digit combination of 0 and 1 to enable/disable sequence status notification.
	SMASK 000000x1 :	Enable(1)/disable(0) sequence pause notification.
	SMASK 0000001x :	Enable(1)/disable(0) sequence end notification.
Application example	SMASK 00000001	Sends a status notification when a sequence is paused.
Query	SMASK?	Queries the sequence status notification setting.
Response example	SMASK 00000001	Issues a status notification when a sequence is paused.
Remarks	<p>The message issued contains a header to identify the unit on the local bus, followed by the system address (%1) of the unit on which the alarm occurred, and the alarm type.</p> <p>The default setting is 00000000.</p> <p>Sequence pause PAUSE %1,1</p> <p>Sequence end END %1,1</p>	

11-3-28. Querying alarm status (ALM)

This command queries alarm status.

Query	ALM?	Queries the alarm status.
Response example	ALM 1	0: Indicates normal operation. 1: Indicates an alarm has occurred.
Remarks		

11-3-29. Alarm reset (EXIT_ALM)

This command resets alarms for recoverable conditions.

Setting	EXIT_ALM	No parameter
Application example	EXIT_ALM	Reset alarm
Remarks	<p>Resettable alarms are as follows:</p> <p>Front output terminal overcurrent</p> <p>Abnormal internal heat</p> <p>Abnormal output (115% or more of rated output)</p> <p>For other alarms, the power must be tuned off and then on again.</p>	

11-3-30. Clearing sequence programs (SCLR)

This command clears sequence programs.

Setting	SCLR x1,x2	Clears a sequence program specified within the range of x1, x2.
Application example	SCLR 1,10	Clears a sequence program from STEP 1 to STEP 10.
Remarks	x2 must be a number that is equal to or greater than x1.	

11-3-31. Writing sequence program (XSWRITE)

This command specifies a sequence program.

Setting	<p>XSWRITE x1,x2,x3,x4,x5,x6,x7,x8,x9,x10 Writes a sequence program.</p> <p>x1: STEP No. 1 - 1000 x2: Set voltage value x3: Set current value x4: Set OVP value x5: Set UVP value x6: Set OCP value x7: Output 0: Off; 1: On; x8: Duration hh/mm/ss/aaa hh : Set hour mm: Set minute ss : Set second aaa: Set m. second x9: Pause setting 0: No pause; 1: Pause x10: CC priority mode 0: Off; 1: On</p>
Application example	<p>XSWRITE 1,3.00,5.00,10.0,0.0,10.0,1,0/0/10/500,0,0</p> <p>STEP No. : 1 Set voltage : 3.0V Set current : 5.0A Set OVP : 10.0V Set UVP : 0.0V Set OCP : 10.0A Output : ON Duration : 10.5 sec. Pause : No pause CC priority mode : OFF</p>
Remarks	<p>Connection time is from 0/0/0/050 to 99/59/59/990.</p>

11-3-32. Reading out a sequence program (XSREAD)

This command requests a sequence program.

Query	XSREAD ?	Requests sequence program data.
Response	XSREAD x1,x2,x3,x4,x5,x6,x7,x8,x9,x10 x1: STEP No. 1 - 1000 x2: Set voltage value x3: Set current value x4: Set OVP value x5: Set UVP value x6: Set OCP value x7: Output 0: Off; 1: On; x8: Duration hh/mm/ss/aaa hh : Set hour mm: Set minute ss : Set second aaa: Set m. second x9: Pause setting 0: No pause, 1: Pause x10: CC priority mode 0: Off, 1: On	
Response example	XSREAD 1,3.00,5.00,10.0,0.0,10.0,1,0/0/10/500,0,0 STEP No. : 1 Set voltage : 3.0V Set current : 5.0A Set OVP : 10.0V Set UVP : 0.0V Set OCP : 10.0A Output : ON Duration : 10.5 sec. Pause : No pause CC priority mode : OFF	
Remarks	Connection time is from 0/0/0/050 to 99/59/59/990.	

11-3-33. Sequence start point setting (SSADR)

This command specifies the starting STEP No. of the sequence.

Setting	SSADR x1	x1: Specifies a number from 1 to 1000 as the starting STEP No. of the sequence.
Application example	SSADR 3	Sets STEP 3 as the start of the sequence.
Query	SSADR?	Queries the starting STEP of the sequence.
Response example	SSADR 5	Indicates the sequence is set to start at STEP 5.
Remarks		

11-3-34. Sequence end point setting (SEADR)

This command specifies the ending STEP No. of the sequence.

Setting	SEADR x1	x1: Specifies a number from 1 to 1000 as the ending STEP No. of the sequence.
Application example	SEADR 3	Sets STEP 3 as the end of the sequence.
Query	SEADR?	Queries the ending STEP of the sequence.
Response example	SEADR 5	Indicates the sequence is set to end at STEP 5.
Remarks		

11-3-35. Sequence execution mode setting (SMODE)

This command selects the sequence execution mode.

Setting	SMODE x1	0: Sets increase as the sequence. 1: Sets increase & decrease as the sequence. 2: Sets decrease as the sequence. 3: Sets decrease & increase as the sequence.
Application example	SMODE 0	Sets increase as the sequence execution.
Query	SMODE?	Queries the sequence execution mode.
Response example	SMODE 0	Indicates increase has been set as the sequence execution mode.
Remarks	Numbers increase from the start STEP toward to the end STEP in increase mode and decrease from the end STEP toward to the start STEP in decrease mode.	

11-3-36. Sequence repeat cycle setting (SCYCLE)

This command specifies the number of times that a sequence cycle is repeated.

Setting	SCYCLE x1	x1: Sets a number from 0 to 1000 as the number of times the sequence cycle is repeated. 0 indicates that the sequence cycle will be repeated infinitely.
Application example	SCYCLE 3	Sets 3 as the number of times the sequence cycle is repeated.
Query	SCYCLE?	Queries the set number of times the sequence cycle is repeated.
Response example	SCYCLE 5	Indicates that 5 has been set as the number of times the sequence cycle is repeated.
Remarks	If the sequence execution mode is increase & decrease, the phase from increase to decrease is considered to be one cycle.	

11-3-37 Sequence mode setting (CHGSEQ)

This command switches the operation mode to sequence operation mode.

Setting	CHGSEQ	Switches from panel operation mode to sequence mode.
Application example	CHGSEQ	
Remarks		

11-3-38. Panel operation mode setting (CHGNORM)

This command switches the operation mode to panel operation mode.

Setting	CHGNORM	Switches from sequence mode to panel operation mode.
Application example	CHGNORM	
Remarks		

11-3-39. Sequence start (SSTART)

This command starts the execution of the sequence.

Setting	SSTART	Starts the execution of the sequence.
Application example	SSTART	
Query	SSTART?	Queries the execution status of the sequence.
Response example	SSTART 0 SSTART 1	Indicates the sequence is not being executed. Indicates the sequence is being executed.
Remarks	If the unit is not in sequence mode, an error will be issued. If no sequence program has been registered, commands will be ignored.	

11-3-40. Sequence stop (SSTOP)

This command stops the sequence.

Setting	SSTOP	Stops the sequence.
Application example	SSTOP	
Query	SSTOP?	Queries the execution status of the sequence.
Response example	SSTOP 0 SSTOP 1	Indicates the sequence has not stopped. Indicates the sequence has stopped.
Remarks	If the unit is not in sequence mode, an error will be issued.	

11-3-41. Sequence pause (SPAUSE)

This command pauses the sequence.

Setting	SPAUSE	Pauses the sequence.
Application example	SPAUSE	
Query	SPAUSE?	Queries the pause status of the sequence.
Response example	SPAUSE 0 SPAUSE 1	Indicates that sequence has not paused. Indicates the sequence has paused.
Remarks	If the unit is not in sequence mode, an error will be issued.	

11-3-42. Sequence jump (SSTEP)

This command moves sequence steps forward or backward.

Setting	SSTEP x1	Moves sequence steps forward or backward. The setting range is from -1000 to 1000.
Application example	SSTEP 10	The sequence jumps forward 10 steps.
Query	SSTEP?	Queries the current step No. of the sequence.
Response example	SSTEP 3	Indicates the current step No. of the sequence is 3.
Remarks	If the unit is not in sequence mode, an error will be issued.	

11-3-43. Reading out the sequence execution status (SRUN)

This command queries the sequence execution status.

Query	SRUN? SRUN x 1, x 2, x 3 x1: Status execution 0: Stopped 1: Executing 3: Paused x2: Current STEP No. x3: Current number of times the cycle is repeated	Queries sequence execution status and step.
Response example	SRUN 1, 3, 2	Indicates the sequence is executing, the current STEP No. is 3, and that the sequence is in its 2 nd cycle.
Remarks	If the unit is not in sequence mode, "stopped" is issued.	

11-3-44. Reset (*RST)

This command resets the PDS-A unit.

Setting	*RST	Resets the PDS-A unit to the initial status for when the power is turned on.
Application example	*RST	
Remarks		

11-3-45. Function reset (RESET)

This command resets the unit to its factory defaults.

Setting	RESET x1	Resets the PDS-A unit. 0: Resets all settings to their factory defaults. 1: Resets the unit to the initial status for when the power is turned on. 2: Reboot the units after saving the configuration.
Application example	RESET 1	This command initializes the panel settings
Remarks	Because the RESET command also resets the communication address, communication will be discontinued.	

11-3-46. Reading out the status byte (*STB)

This command queries the status byte.

Query	*STB?	Queries the status byte.
Response form	*STB x1	<p>0,64: An alarm for a recoverable condition has been issued or an OCP has occurred in the unit.</p> <p>1,65: AC input alarm has occurred in the unit.</p> <p>2,66: UVP has occurred in the unit.</p> <p>3,67: OVP has occurred in the unit.</p> <p>4,68: The unit has switched from CC mode to CV mode.</p> <p>5,69: The unit has switched from CV mode to CC mode.</p> <p>6,70: Sequence operation in the unit has stopped.</p> <p>7,71: A command error has occurred in communication.</p> <p>8,72: A parameter error has occurred in communication.</p> <p>9,73: A run error has occurred in communication.</p> <p>10,74: A warning was issued during communication (out of range, etc.).</p> <p>13,77: Sequence operation in the unit has paused.</p> <p>If another situation occurs before acquiring status byte, the previous status will be lost.</p>
Application example	*STB 68	The unit has switched from CC mode to CV mode.
Remarks		

11-3-47. Reading out the product information (*IDN)

This command queries the device information.

Query	*IDN?	Queries the device information.
Response form	*IDN x1,x2,0,x3 x1: Company name x2: Product name x3: "0" Fixed x4: Version No.	
Response example	*IDN TEXIO TECHNOLOGY,PDSA-Series,0,2.01	
Remarks		

11-3-48. Querying the model and specifications (MODEL)

queries the device information

Query	MODEL?	Queries device information.
Response form	MODEL x1,x2,x3 x1: Series No. 21: 6V series 22: 10V series 23: 20V series 24: 40V series 25: 60V series 26: 36V series x2: Maximum voltage x3: Maximum current	
Response example	MODEL 22,10.25,41.00	Maximum voltage 10.25V, maximum current 41.00A
Remarks		

11-3-49. Local bus setting (ADRS)

The command sets the system address of controlled units when they are connected via the local bus.

Setting	ADRS x1	Specifies a device in local bus.
Application example	ADRS 3	Controls the unit whose system address is "3".
Query	ADRS?	Queries the system address of the controlled unit.
Response example	ADRS 5	Indicates "5" is the system address of the unit controlled by the local bus.
Remarks	<p>If the assigned system address is "0", all the devices will operate independently of the local address (broadcast operation). If a query command that requests a response is used at this time, normal operation of the bus will be impeded. Avoid using a query command in this situation.</p> <p>The system address of the unit connected to the PC should be "1".</p>	

11-3-50. Returning the product name of the unit (UNIT?)

This command queries the product name of the unit.

Query	UNIT?	Queries the product name of the unit.
Response example	UNIT PDS20-10A	Product name of the unit
Remarks		

11-3-51. Query-dedicated PC address for device identification (LPCAD?)

Querying the device number used to identify the PC address when controlled by a LAN.

Query	LPCAD?	Queries the product name of the unit.
Response form	LPCAD x1	-1: Query that is not LAN-based. 0 to 31: Registered PC address for the LAN.
Response example	LPCAD 0	
Remarks	Used to identify devices when the IP address is automatically allocated by the DHCP.	

11-4. Cautions about communication

Remember to observe the following points about communication:

- Do not use a long cable for communication.
- Keep the communication cable as far as possible from the noise source.
- For continuous communication that creates a heavy burden, conduct a long-term test to confirm that no conflicts occur.
- If local bus is used, set a longer wait period to avoid communication conflicts.
- If broadcast operation is performed in the local bus, avoid using query commands.
- When connecting to PC, pay attention to the potential difference and leakage current in the GND line.

11-5. Compatibility of PDS-A series and PDS series.

The following attention is necessary about the compatibility of the external communication specifications of PDS-A power supply and the PDS power supply.

GP-IB control : IF-70GU

- As for the PDS-A power supply, the communication command is compatible with PDS power supply. Please refer to PDS power supply instruction manual for the PDS command.
- With PDS-A power supply and the PDS power supply, a compatible winged ant of the hardware is not precocious. Therefore, in the case of substitution, timings may slip off in communication movement.
- The address setting sets it by the menu operation of the front panel. Please refer to page 78 for the details of the setting.
- Connection confirmation sets it by the menu operation of the front panel. Please refer to page 79 for the details of the confirmation method.

RS-232C control : IF-71RS

- As for the PDS-A power supply, the communication command is compatible with PDS power supply. Please refer to PDS power supply instruction manual for the PDS command.
- With PDS-A power supply and the PDS power supply, a compatible winged ant of the hardware is not precocious. Therefore, in the case of substitution, timings may slip off in communication movement.
- Control is different from hardware standard specifications(PS-A) in the specifications compatible with PDS. Therefore, setting of DIP switch (S2) is necessary when you use specifications compatible with PDS power supply command in IF-71RS.
Please refer to page 76 for the details of the setting. In addition, please refer to page 81 for the confirmation of the communication condition.
- The baud rate setting sets it by the menu operation of the front panel. Please refer to page 38 for the details of the setting.
- Connection confirmation sets it by the menu operation of the front panel. Please refer to page 79 for the details of the confirmation method.

11-6. Communication Specifications

● IF-71RS

RS-232C		
Specification	Compatible with RS-232C	
Date transfer speed	PS-A / PSR	9600[bps]
	PDS	1200/2400/4800/9600/19200[bps]
Data bit	PS-A / PSR	Half duplex. Data: 7[bit]. Stop bit: 1[bit]. Parity: Even number.
	PDS	Full duplex. Data: 8[bit]. Stop bit: 1[bit]. Parity: None.
Maximum code length	10[m]	
Connector type	D-sub 9 pins, male, #4-40UNC	
Applicable cable	Commercially available interlink cable (9 pins, female ↔ 9 pins, female)	
Number of connectable units	1-to-1 connection only	
Local bus		
Specification	Compatible with RS-485, dedicated protocol (No setup necessary, compatible with PSR-M series)	
Maximum code length	1.2[km]	
Connector type	RJ-11 (6-pin modular)	
Applicable cable	Dedicated modular cable	
Terminator	Can be switched on/off by using a jumper pin. Only both ends of the cable should be on.	
Number of ports	2 ports, no orientation	
PSR bus		
Specification	5VTTL level, dedicated protocol (compatible with PSR series)	
Maximum code length	10[m]	
Connector type	RJ-11 (6-pin modular)	
Applicable cable	Dedicated modular cable	
Number of ports	2 ports, no orientation	

● IF-70GU

USB	
Specification	Supports USB Revision 2.0, full speed
Connector type	USB series B
Device class	Dedicated device class. Device driver for Windows is available separately.
Vender code	098F
Product code	1007
Power supply	Self-power only
Number of connectable units	A maximum of 30 units via USB hub.
GP-IB	
Specification	Compliant with IEEE488-1978 specifications.
Interface function	SH1,AH1,T6,L4,SR1,RL1,PP0,DC1,DT0,C0,E1
Address setting	Addresses can be freely set from 1 to 30.
Delimiter	LF and EOI
Listener function	Output conditions of controlled units can be set.
Talker function	The output status and settings of controlled units can be detected.
Service request function	The status report function is available.
Number of connectable units	A maximum of 14 units can be connected on a single bus.
Local bus	
Specification	Compatible with RS-485, dedicated protocol
Maximum code length	1.2[km]
Connector type	RJ-11 (6-pin modular)
Applicable cable	Dedicated modular cable
Terminator	Can be switched on/off by using a jumper pin. Only both ends of the cable should be on.
Number of ports	2 ports, no orientation

● IF-71LU

USB	
Specification	Supports USB Revision 2.0, full speed
Connector type	USB series B
Device class	Dedicated device class Device driver for Windows is available separately.
Vender code	098F
Product code	1007
Power supply	Self-power only
Number of connected units	A maximum of 30 units via USB hub
LAN	
Specification	XPort (Lantronix)
Protocol	TCP/IP, DHCP, HTTP, and Auto IP
Communication compatibility	Ethernet: IEEE 802.3
Ethernet interface	RJ45 (10BASE-T, 100BASE-TX)
Control method	Socket communication, virtual COM port control
Local bus	
Specifications	Compatible with RS-485, dedicated protocol
Maximum code length	1.2 [km]
Connector type	RJ-11 (6-pin modular)
Applicable cable	Dedicated modular cable
Terminator	Can be switched on/off by using a jumper pin. Only both ends of the cable should be on.
Number of ports	2 ports, no orientation

※ In regards to the local bus, IF-70GU, IF-71RS and IF-71LU share the same specification, thus they can be used together.

※ We offer dedicated modular cables. Please contact our service center or one of our sales branches.

● Voltage Setting

Rated voltage [V]	Output setting range [V]	Over-voltage protection range [V]	Under-voltage protection range [V]
20	0.00 ~ 20.50	2.0 ~ 22.0	-1.0 ~ 22.0
36	0.00 ~ 36.90	3.6 ~ 39.6	-1.0 ~ 39.6
40	0.00 ~ 41.00	4.0 ~ 44.0	-1.0 ~ 44.0
60	0.00 ~ 60.15	6.0 ~ 66.0	-1.0 ~ 66.0
72	0.00 ~ 72.00	7.2 ~ 79.2	-1.0 ~ 79.2
120	0.0 ~ 123.0	12.0 ~ 132.0	-1.0 ~ 132.0

* Rated voltages for serial master-slave arrangement.

● Current Setting

Rated current [A]	Output setting range [A]	Over-current protection range [A]
6	0.00 ~ 6.15	0.3 ~ 6.6
10	0.00 ~ 10.25	0.5 ~ 11.0
12	0.00 ~ 12.30	0.6 ~ 13.2
18	0.00 ~ 18.45	0.9 ~ 19.8
20	0.00 ~ 20.50	1.0 ~ 22.0
24	0.00 ~ 24.60	1.2 ~ 26.4
30	0.00 ~ 30.75	1.5 ~ 33.0
36	0.00 ~ 36.90	1.8 ~ 39.6
40	0.00 ~ 41.00	2.0 ~ 44.0
54	0.00 ~ 55.35	2.7 ~ 59.4
60	0.00 ~ 61.50	3.0 ~ 66.0
72	0.00 ~ 73.80	3.6 ~ 79.2
108	0.0 ~ 110.7	5.4 ~ 118.8

* Rated currents for both serial and parallel master-slave arrangements.

Appendix A. TROUBLE SHOOTING

If the PDS-A power supply unit becomes defective, check the following items.

Phenomenon	Possible cause	Action
Power is not turned on even when the POWER switch is thrown. (The front panel LED is not lit.)	The AC cable is not connected securely or is broken.	Securely connect the AC cable. Or, replace the AC cable if it is broken.
	An error in the PDS-A power supply unit has caused the fuse to blow.	The internal fuse must be replaced. Please contact our service center.
	AC input voltage is too low.	Adjust the AC voltage.
“ALП” is displayed when the POWER switch is thrown.	The set voltage that is input in the PDS-A power supply unit exceeds the permissible AC input voltage range.	The permissible AC input voltage range is 100VAC to 240VAC, 50Hz to 60Hz.
“P-oF” is displayed when the POWER switch is thrown.	SW1-1 of the external analog board has been switched on.	Switch off the external analog board SW1-1.
	Main relay has been off by digital communication interface.	Set to on by “Power 1” and “PONPOW 1” commands.
“ScAn Err” is displayed when the POWER switch is thrown in parallel master-slave connection.	The wrong number of units has been set.	Correct the setting for the number of units.
	The dedicated cable is not connected to the J1 connector on the rear panel.	Connect the dedicated cable to the J1 connector on the rear panel.
	A cable other than the dedicated cable is connected to the J1 connector on the rear panel.	Make sure to only use the dedicated cable.
No voltage is output, even when the output is turned on in serial master-slave connection.	The dedicated cable is not connected to the J1 connector on the rear panel.	Connect the dedicated cable to the J1 connector on the rear panel.
	A cable other than the dedicated cable is connected to the J1 connector on the rear panel.	Make sure to only use the dedicated cable.
No voltage is output, even when the output is turned on.	The current is set to 0.00 A in CC mode.	Increase the set current.
“ALП” is displayed when the front output terminals are used.	A current of 20A or more is flowing to the load from the PDS-A power supply unit.	The current of front output terminals is 20A or less. Use the rear output terminals.
“ALП” is displayed when the output is turned on.	The remote sensing terminal is not connected to the load.	Connect the remote sensing terminal to the load.
	The short bar to connect the output terminal and the remote sensing terminal is disconnected.	Use the short bar to connect the output terminal and the remote sensing terminal.
Voltage does not fall, even after the output has been turned off.	A capacitive load is connected to the PDS-A power supply unit.	Before touching the output terminals, use a voltmeter to measure the voltage of the unit’s output terminals to confirm voltage has fallen.
	Output HI-R function is turned on.	Turn off the output HI-R function.
Output voltage is unstable or excessive noise has been input.	Commercial frequency noises have been detected due to low AC input voltage.	Adjust the AC input voltage.
	There is a strong magnetic or electrical field nearby.	Take the proper countermeasures. Move the unit away from equipment that may produce a magnetic or electrical field and twist the wires.

- Contact our service center if you encounter a phenomenon that is not described above, or if the problem persists even after the above causes have been eliminated.

Appendix B. OUTSIDE DIMENSIONS

- 200W/360W type: (124 mm (H) × 140 mm (W) × 364 mm (D)). Weight: Approx. 5.2 kg

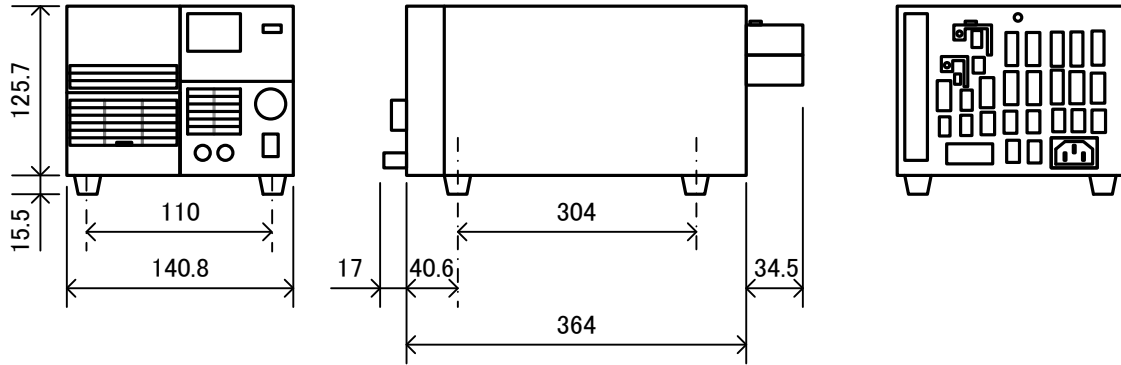

- 720W type: (124 mm (H) × 210 mm (W) × 364 mm (D)). Weight: Approx. 7.5 kg

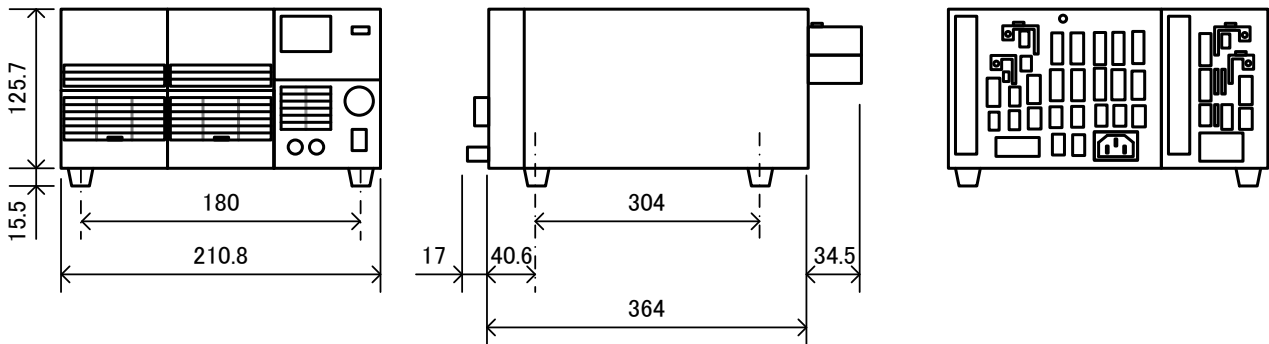

Appendix C. SPECIFICATIONS

Individual Specifications

	PDS20-10A	PDS20-18A	PDS20-36A	PDS36-6A	PDS36-10A	PDS36-20A	PDS60-6A	PDS60-12A
Rated power	200W	360W	720W	216W	360W	720W	360W	720W
Output voltage	0V to 20V			0V to 36 V			0V to 60 V	
Voltage setting resolution	10mV			10mV			10mV	
Voltage setting accuracy	± (0.5%SET+0.5%F.S): 23°C±5°C, after 30-minute aging.			± (0.5%SET+0.5%F.S): 23°C±5°C, after 30-minute aging.			± (0.5%SET+0.5%F.S): 23°C±5°C, after 30-minute aging.	
Output current	0A to 10A	0A to 18A	0A to 36A	0A to 6A	0A to 10A	0A to 20A	0A to 6A	0A to 12A
Current setting resolution	10mA			10mA			10mA	
Current setting accuracy	± (1%SET+1%F.S): 23°C±5°C, after 30-minute aging.			± (1%SET+1%F.S): 23°C±5°C, after 30-minute aging.			± (1%SET+1%F.S): 23°C±5°C, after 30-minute aging.	
Constant-voltage characteristics								
Source fluctuation ^{*1}	0.005%FS+1mV			0.005%FS+1mV			0.005%FS+1mV	
Load fluctuation ^{*2}	0.005%FS+2mV			0.005%FS+2mV			0.005%FS+2mV	
Ripple ^{*3}	0.5mVrms			0.5mVrms			0.5mVrms	
Noise (p-p) ^{*4}	30mVp-p			30mVp-p			30mVp-p	
Rise time (typ)	50ms/50ms: No load/Rated load Output voltage: 10%→90%FS			50ms/50ms: No load/Rated load Output voltage: 10%→90%FS			50ms/50ms: No load/Rated load Output voltage: 10%→90%FS	
Fall time (typ)	250ms/50ms: No load/Rated load Output voltage: 90%→10%FS			250ms/50ms: No load/Rated load Output voltage: 90%→10%FS			600ms/150ms: No load/Rated load Output voltage: 90%→10%FS	
Transient response (typ)	100μS			100μS			100μS	
Temperature coefficient (typ)	±100ppm/°C			±100ppm/°C			±100ppm/°C	
Constant-current characteristics								
Source fluctuation ^{*1}	5mA	10mA		1mA	5mA		1mA	5mA
Load fluctuation ^{*5}	5mA			5mA			5mA	
Ripple ^{*3}	10mArms			5mArms	10mArms		5mArms	10mArms
Temperature coefficient (typ)	±100ppm/°C			±100ppm/°C			±100ppm/°C	
Indicators								
Voltage display range	-10%FS to +110%FS			-10%FS to +110%FS			-10%FS to +110%FS	
Voltage display accuracy	±(0.1%rdg+2digit): 23°C±5°C, after 30-minute aging.			±(0.1%rdg+2digit): 23°C±5°C, after 30-minute aging.			±(0.1%rdg+2digit): 23°C±5°C, after 30-minute aging.	
Current display range	0%FS to +110%FS			0%FS to +110%FS			0%FS to +110%FS	
Current display accuracy	±(0.5%rdg+2digit): 23°C±5°C, after 30-minute aging.			±(0.5%rdg+2digit): 23°C±5°C, after 30-minute aging.			±(0.5%rdg+2digit): 23°C±5°C, after 30-minute aging.	
Power display range	0%FS to +110%FS			0%FS to +110%FS			0%FS to +110%FS	
Power display resolution	0.1W			0.1W			0.1W	
Power display accuracy	±(0.7%rdg+1.5%F.S): 23°C±5°C, after 30-minute aging.			±(0.7%rdg+1.5%F.S): 23°C±5°C, after 30-minute aging.			±(0.7%rdg+1.5%F.S): 23°C±5°C, after 30-minute aging.	
Power Consumption: 100VAC input, rated power output								
Input voltage	Single-phase 100VAC to 240VAC, 50Hz to 60Hz			Single-phase 100VAC to 240VAC, 50Hz to 60Hz			Single-phase 100VAC to 240VAC, 50Hz to 60Hz	
Power consumption (typ)	340W	570W	1100W	330W	520W	1050W	510W	1000W
	340VA	570VA	1100VA	330VA	520VA	1050VA	510VA	1000VA
Power factor (typ)	0.99			0.99			0.99	

^{*1} For ±10% fluctuation of the input voltage.

^{*2} Measurements of the remote sensing terminal to detect 0% to 100% fluctuations of output current.

^{*3} Application of RMS method to conduct measurements at a frequency of 5Hz to 1MHz.

^{*4} Noise measured by 20 MHz oscilloscope.

^{*5} For fluctuations of 0% to 100%.

Common Specifications of PDS-A Series

	200W/360W type	720W type
Over-voltage protection	Set range: 10% to 110% FS. Set resolution: 10 times the minimum display resolution. Activated when the output voltage exceeds the set OVP value: Hardware detection.	
Under-voltage protection	Set range: -1V to 110% FS. Set resolution: 10 times the minimum display resolution. Activated when the output voltage falls below the set UVP value: Software detection.	
Over-current protection	Set range: 5% to 110% FS. Set resolution: 10 times of minimum display resolution. Activated when the output current exceeds set OCP value: Software detection.	
Compensating voltage range of remote sensing	1.5V one way: Output power no greater than the rated voltage.	
Grounding	Positive or negative grounding	
Protective functions	Overinput voltage, underinput voltage: Main relay off. Overcurrent of front output, internal overheat, overoutput voltage, overoutput current: Output off.	
Cooling method	Forced cooling: Fan speed proportionate to the temperature of the internal heat sink.	
Operating temperature range	0°C to 40°C	
Operating humidity range	30% to 85%RH (No dew condensation)	
Storage temperature range	-20°C to 60°C	
Storage humidity range	20% to 85%RH (No dew condensation)	
Dielectric strength voltage	Primary-casing: 1500VAC. 1 minute. Primary-secondary: 3200VDC, 1 minute.	
Insulation resistance	Primary-casing: 500VDC 30MΩ or more. Secondary-casing: 500VDC 20MΩ or more.	
To-GND voltage	±250VDC	
External dimensions [mm]	124 (H) * 140(W) *364(D)	124 (H) * 210(W) *364(D)
Maximum dimensions [mm]	139.5 (H) * 140(W) *415.5(D)	139.5 (H) * 210(W) *415.5(D)
Weight	Approx. 5.2kg	Approx. 7.5kg
Accessories	Power cable: 1 piece. Instruction manual: 1 set. Rear output terminal cover: 1 piece. Bolt set: 1 set. Output-grounding cable: 1 piece. M4 Small screw washer: 1 piece. M3 small screw washer: 1 piece. M3 large screw washer: 2 pcs.	

Applicable Standards of PDS-A

Compatible specification ※6	LVD※8		EN61010-1:2010 (Edition 3) Indoor use / Max. altitude 2000 m / Over-voltage category II / Pollution degree 2
	EMC	EMS (MIN)	EN61326-1:2013
		EMI (class A)	EN61326-1:2013
	Power supply harmonic current		EN61000-3-2:2000
	Conditions for specification conformance※7		Use the unit with the power cable wound once around the accessory core. Use the unit with a secure ground connection via the protective groundingterminal on the bottom face of the unit.

※6 Applicable only for units with the CE mark on the rear panel. NOT applicable for modified units.

※7 Conditions for specification conformance when the optional board IF-70GU or IF-71RS is installed: The USB/GP-IB/RS-232C/modular cables used for connection must be less than 3m in length.

Conditions for specification conformance when the optional board IF-70GU or IF-71RS is installed: Both ends of the USB/modular cables to which a core (TDK : ZCAT2035-0930A-M or equivalent product) is attached must be wound twice.

※8 If you do not connect the protective grounding terminal on the bottom face, it will come off from the CE conformity.



TEXIO TECHNOLOGY CORPORATION

7F Towa Fudosan Shin Yokohama Bldg.

2-18-13, Shin Yokohama, Kouhoku-ku, Yokohama, Kanagawa, 222-0033 Japan

<http://www.texio.co.jp/>
