

INSTRUCTION MANUAL

Arbitrary Function Generator FGX-2005 FGX-2112



■ **About Brands and Trademarks**

“TEXIO” is the product brand name of our industrial electronic devices.

All company names and product names mentioned in this manual are the trademark or the registered trademark of each company or group in each country and region.

■ **About the Instruction Manual**

Permission from the copyright holder is needed to reprint the contents of this manual, in whole or in part. Be aware that the product specifications and the contents of this manual are subject to change for the purpose of improvement.

CONTENTS

USING THE PRODUCT SAFELY	I -IV
1. GETTING STARTED	1
1-1. Main Features	1
1-2. Panel Overview	2
1-3. Rear Panel	5
1-4. Display	6
1-5. Setting up the Function Generator	7
2. QUICK REFERENCE	9
2-1. How to use the Digital Inputs	9
2-2. Selecting a Waveform	10
2-2-1. Sine Wave	10
2-2-2. Square Wave	10
2-2-3. Ramp Wave	11
2-3. ARB	11
2-4. Modulation	12
2-4-1. AM (FGX-2112 only)	12
2-4-2. FM (FGX-2112 only)	12
2-4-3. FSK Modulation (FGX-2112 only)	13
2-5. Sweep (FGX-2112 only)	14
2-6. Counter (FGX-2112 only)	15
2-7. Save/Recall	15
2-7-1. Save	15
2-7-2. Recall	15
2-8. Default Settings	16
3. OPERATION	17
3-1. Select a Waveform	17
3-2. Setting the Frequency	17
3-3. Setting the Amplitude	18
3-4. Setting the DC Offset	19
3-5. Setting the Duty Cycle/Symmetry	20
3-6. Setting the Load Impedance	21
3-7. Turning the Output On	22
3-8. Amplitude Modulation (AM) (FGX-2112)	22
3-8-1. Selecting AM Modulation	22
3-8-2. AM Carrier Waveform	23
3-8-3. Setting the Carrier Frequency	23
3-8-4. Setting the Carrier Amplitude	24
3-8-5. Setting the Modulating Wave Shape	25
3-8-6. Setting the Modulation Frequency (Rate)	25
3-8-7. Modulation Depth	26
3-8-8. Setting the Modulation Source	27
3-9. Frequency Modulation (FM)(FGX-2112)	28
3-9-1. Selecting FM Modulation	28
3-9-2. FM Carrier Waveform	29
3-9-3. Setting the Carrier Frequency	29

3-9-4. Setting the Carrier Amplitude.....	30
3-9-5. Setting the Modulating Wave Shape.....	31
3-9-6. Setting the Modulation Frequency (Rate)	31
3-9-7. Frequency Deviation.....	32
3-9-8. Setting the Modulation Source.....	33
3-10. Frequency Shift Keying (FSK) Modulation (FGX-2112).....	34
3-10-1. Selecting FSK Modulation	35
3-10-2. FSK Carrier Waveform	35
3-10-3. FSK Carrier Frequency.....	35
3-10-4. Setting the Carrier Amplitude.....	36
3-10-5. Setting the Hop Frequency.....	37
3-10-6. FSK Rate.....	38
3-10-7. Setting the FSK Source	39
3-11. Frequency Sweep (FGX-2112)	40
3-11-1. Selecting Sweep	40
3-11-2. Setting Start and Stop Frequency	41
3-11-3. Sweep Mode.....	42
3-11-4. Sweep Rate	42
3-11-5. Setting the Sweep Source (Trigger).....	43
3-12. Creating an Arbitrary Waveform	44
3-13. Using the Frequency Counter	46
3-13-1. Selecting the Frequency Counter Function.....	46
3-13-2. Selecting the Gate Time	46
3-14. Using the SYNC Output Port	47
3-14-1. Connecting the SYNC Output Port	47
3-14-2. SYNC Output Signal.....	47
3-15. Save and Recall State/ARB Waveform	49
4. REMOTE INTERFACE	51
4-1. Selecting the USB Remote Interface.....	51
4-1-1. Remote control terminal connection	51
4-2. Command Syntax	52
4-3. Command List	56
4-3-1. System Commands	57
4-3-1-1. *IDN?.....	57
4-3-1-2. *RST.....	57
4-3-2. Status Register Commands.....	57
4-3-2-1. *CLS	57
4-3-3. APPLy Commands.....	57
4-3-3-1. SOURce[1]:APPLy:SINusoid.....	59
4-3-3-2. SOURce[1]:APPLy:SQUare.....	59
4-3-3-3. SOURce[1]:APPLy:RAMP	59
4-3-3-4. SOURce[1]:APPLy:NOISe.....	60
4-3-3-5. SOURce[1]:APPLy:USER.....	60
4-3-3-6. SOURce[1]:APPLy?	61
4-3-4. Output Commands	61
4-3-4-1. SOURce[1]:FUNCTION.....	61
4-3-4-2. SOURce[1]:FREQUency.....	62
4-3-4-3. SOURce[1]:AMPLitude.....	63
4-3-4-4. SOURce[1]:DCOffset.....	64

4-3-4-5. SOURce[1]:SQUare:DCYCLe.....	64
4-3-4-6. SOURce[1]:RAMP:SYMMetry	65
4-3-4-7. OUTPut.....	66
4-3-4-8. SOURce[1]:OUTPut:LOAD.....	66
4-3-4-9. SOURce[1]:VOLTage:UNIT.....	66
4-3-5. Amplitude Modulation (AM) Commands	67
4-3-5-1. SOURce[1]:AM:STATe.....	68
4-3-5-2. SOURce[1]:AM:SOURce.....	68
4-3-5-3. SOURce[1]:AM:INTernal:FUNCTion.....	69
4-3-5-4. SOURce[1]:AM:INTernal:FREQuency.....	69
4-3-5-5. SOURce[1]:AM:DEPTh	69
4-3-6. Frequency Modulation (FM) Commands	70
4-3-6-1. SOURce[1]:FM:STATe.....	71
4-3-6-2. SOURce[1]:FM:SOURce.....	71
4-3-6-3. SOURce[1]:FM:INTernal:FUNCTion.....	71
4-3-6-4. SOURce[1]:FM:INTernal:FREQuency.....	72
4-3-6-5. SOURce[1]:FM:DEViation	72
4-3-7. Frequency-Shift Keying (FSK) Commands.....	73
4-3-7-1. SOURce[1]:FSKey:STATe.....	74
4-3-7-2. SOURce[1]:FSKey:SOURce.....	74
4-3-7-3. SOURce[1]:FSKey:FREQuency.....	75
4-3-7-4. SOURce[1]:FSKey:INTernal:RATE	75
4-3-8. Frequency Sweep Commands	76
4-3-8-1. SOURce[1]:SWEep:STATe.....	76
4-3-8-2. SOURce[1]:FREQuency:START	77
4-3-8-3. SOURce[1]:FREQuency:STOP	77
4-3-8-4. SOURce[1]:SWEep:SPACing.....	78
4-3-8-5. SOURce[1]:SWEep:RATE.....	78
4-3-8-6. SOURce[1]:SWEep:SOURce.....	78
4-3-9. Frequency Counter Commands.....	79
4-3-9-1. COUNter:GATe	79
4-3-9-2. COUNter:STATe.....	79
4-3-9-3. COUNter:VALue?.....	80
4-3-10. Arbitrary Waveform Commands.....	80
4-3-10-1. SOURce[1]:FUNCTion USER.....	81
4-3-10-2. DATA:DAC	81
4-3-11. Save and Recall Commands	82
4-3-11-1. *SAV.....	82
4-3-11-2. *RCL.....	82
5. APPENDIX	84
5-1. Error Messages	84
5-2. FGX-2000 Series Specifications	85
5-3. External Dimensions Figure	88



USING THE PRODUCT SAFELY

■ Preface

To use the product safely, read instruction manual to the end. Before using this product, understand how to correctly use it. If you read the manuals but you do not understand how to use it, ask us or your local dealer. After you read the manuals, save it so that you can read it anytime as required.

■ Pictorial indication

The manuals and product show the warning and caution items required to safely use the product. The following pictorial indication is provided.

Pictorial indication	
	Some part of this product or the manuals may show this pictorial indication. In this case, if the product is incorrectly used in that part, a serious danger may be brought about on the user's body or the product. To use the part with this pictorial indication, be sure to refer to the manuals.
 	If you use the product, ignoring this indication, you may get killed or seriously injured. This indication shows that the warning item to avoid the danger is provided. If you incorrectly use the product, ignoring this indication, you may get slightly injured or the product may be damaged. This indication shows that the caution item to avoid the danger is provided.

Please be informed that we are not responsible for any damages to the user or to the third person, arising from malfunctions or other failures due to wrong use of the product or incorrect operation, except such responsibility for damages as required by law.

USING THE PRODUCT SAFELY



■ Do not remove the product's covers and panels

Never remove the product's covers and panels for any purpose. Otherwise, the user's electric shock or fire may be incurred.

■ Warning on using the product

Warning items given below are to avoid danger to user's body and life and avoid the damage or deterioration of the product. Use the product, observing the following warning and caution items.

■ Warning items on power supply

● Power supply voltage

The rated power supply voltages of the product are 100, 120, 220 and 240VAC. The rated power supply voltage for each product should be confirmed by reading the label attached on the back of the product or by the "rated" column shown in the instruction manual. The specification of power cord attached to the products is rated to 125VAC for all products which are designed to be used in the areas where commercial power supply voltage is not higher than 125VAC. Accordingly, you must change the power cord if you want to use the product at the power supply voltage higher than 125VAC. If you use the product without changing power cord to 250VAC rated one, electric shock or fire may be caused. When you used the product equipped with power supply voltage switching system, please refer to the corresponding chapter in the instruction manuals of each product.

● Power cord

(IMPORTANT) The attached power cord set can be used for this device only.

If the attached power cord is damaged, stop using the product and call us or your local dealer. If the power cord is used without the damage being removed, an electric shock or fire may be caused.

● Protective fuse

If an input protective fuse is blown, the product does not operate. For a product with external fuse holder, the fuse may be replaced. As for how to replace the fuse, refer to the corresponding chapter in the instruction manual. If no fuse replacement procedures are indicated, the user is not permitted to replace it. In such case, keep the case closed and consult us or your local dealer. If the fuse is incorrectly replaced, a fire may occur.

USING THE PRODUCT SAFELY

■ Warning item on Grounding

If the product has the GND terminal on the front or rear panel surface, be sure to ground the product to safely use it.

■ Warnings on Installation environment

● Operating temperature and humidity

Use the product within the operating temperature indicated in the “rating” temperature column. If the product is used with the vents of the product blocked or in high ambient temperatures, a fire may occur. Use the product within the operating humidity indicated in the “rating” humidity column. Watch out for condensation by a sharp humidity change such as transfer to a room with a different humidity. Also, do not operate the product with wet hands. Otherwise, an electric shock or fire may occur.

● Use in gas

Use in and around a place where an inflammable or explosive gas or steam is generated or stored may result in an explosion and fire. Do not operate the product in such an environment. Also, use in and around a place where a corrosive gas is generated or spreading causes a serious damage to the product. Do not operate the product in such an environment.

● Installation place

Do not insert metal and inflammable materials into the product from its vent and spill water on it. Otherwise, electric shock or fire may occur.

■ Do not let foreign matter in

Do not insert metal and inflammable materials into the product from its vent and spill water on it. Otherwise, electric shock or fire may occur.

■ Warning item on abnormality while in use

If smoke or fire is generated from the product while in use, stop using the product, turn off the switch, and remove the power cord plug from the outlet. After confirming that no other devices catch fire, ask us or your local dealer.

USING THE PRODUCT SAFELY

■ Input / Output terminals

Maximum input to terminal is specified to prevent the product from being damaged. Do not supply input, exceeding the specifications that are indicated in the "Rating" column in the instruction manual of the product. Also, do not supply power to the output terminals from the outside. Otherwise, a product failure is caused.

■ Calibration

Although the performance and specifications of the product are checked under strict quality control during shipment from the factory, they may be deviated more or less by deterioration of parts due to their aging or others.

It is recommended to periodically calibrate the product so that it is used with its performance and specifications stable. For consultation about the product calibration, ask us or your local dealer.

■ Daily Maintenance

When you clean off the dirt of the product covers, panels, and knobs, avoid solvents such as thinner and benzene. Otherwise, the paint may peel off or resin surface may be affected. To wipe off the covers, panels, and knobs, use a soft cloth with neutral detergent in it.

During cleaning, be careful that water, detergents, or other foreign matters do not get into the product.

If a liquid or metal gets into the product, an electric shock and fire are caused.

During cleaning, remove the power cord plug from the outlet.

Use the product correctly and safely, observing the above warning and caution items. Because the instruction manual indicates caution items even in individual items, observe those caution items to correctly use the product.

If you have questions or comments about the manuals, ask us or E-Mail us.

1. GETTING STARTED

The Getting started chapter introduces the function generator's main features, appearance and introduces a quick instructional summary of some of the basic functions. For comprehensive operation instructions, please see the operation chapter.

1-1. Main Features

Model name	FGX-2005	FGX-2112
Frequency Range	0.1Hz~5MHz	0.1Hz~12MHz
Output waveform	Sine, Square, Ramp, Noise, ARB	
Amplitude range	1 mVpp to 10 Vpp (into 50Ω) 2 mVpp to 20 Vpp (open-circuit)	
Variable Offset	✓	✓
Variable Duty	✓	✓
SYNC (TTL) output	✓	✓
Save/Recall	✓	✓
Sweep operation	—	✓
AM /FM / FSK	—	✓
Frequency Counter	—	✓
ARB	✓	✓
USB Interface	✓	✓

Performance	<ul style="list-style-type: none"> • DDS technology using an FPGA provides high resolution waveforms • 12MHz/5MHz DDS (Direct Digital Synthesis) signal output series • 0.1Hz resolution • Full Function Arbitrary Waveform Capability <ul style="list-style-type: none"> 20 MSa/s sample rate 10 MHz repetition rate 4 k-point waveform length 10-bit amplitude resolution Ten 4k waveform memories
Features	<ul style="list-style-type: none"> • Sine, Square, Ramp, Noise • Int/Ext AM, FM, FSK modulation • Modulation/sweep signal output • Save/recall 10 groups of setting memories • Output overload protection
Interface	<ul style="list-style-type: none"> • USB interface as standard • 3.5 inch LCD

1-2. Panel Overview FGX-2112 Front Panel

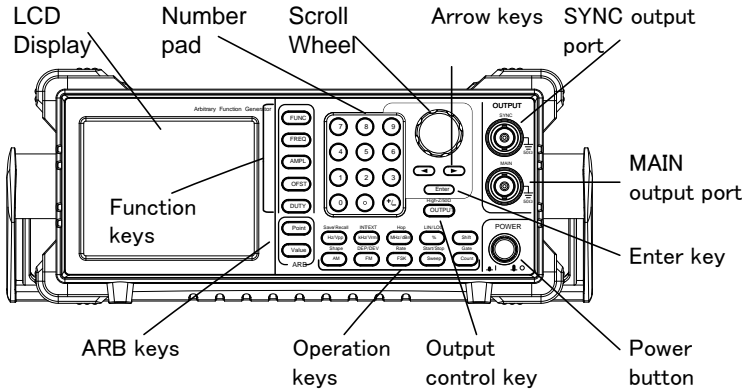

LCD display
Keypad

3.5 inch, 3 color LCD display.

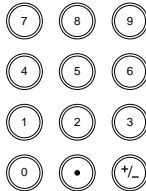

The digital keypad is used to enter values and parameters. The keypad is often used in conjunction with the selection keys and variable knob.

Scroll Wheel

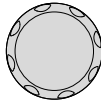

The scroll wheel is used to edit values and parameters in steps of 1 digit. Used in conjunction with the arrow keys.

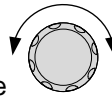

Arrow keys



Used to select digits when editing parameters.

Output ports

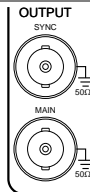

SYNC output port (50Ω impedance).

Main output port (50Ω impedance).

Enter key

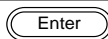





































Used to confirm input values.

Power button

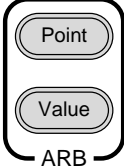

Turns the instrument power on/off.

Output control key		Turns the output on/off.
Load Impedance	 + High Z/50Ω	Toggles the load impedance between 50Ω and High-Z.
		
Operation keys		Selects Hz or Vpp units.
	 + 	Saves or recalls waveforms from memory.
		Selects kHz or Vrms units.
	 + 	Sets the source to internal or external for the modulation and FSK functions*.
		Selects MHz or dBm units.
	 + 	Sets the “Hop” frequency for FSK modulation*.
		Selects % units.
	 + 	Sets the sweep to linear or logarithmic*.
		The shift key is used to select the secondary functions on the operation keys.
		The AM key is used to turn AM modulation on/off*.
	 + 	Selects the modulation waveform*.
		The FM key is used to turn FM modulation on/off*.
	 + 	Selects the modulation depth or the frequency deviation*.
		Selects FSK modulation*.
	 + 	Sets the AM, FM, FSK modulation and sweep function rate*
		Selects the Sweep function*.
	 + 	Sets the Start or Stop frequency*.

		Turns the frequency counter on/off*.
	 + 	Sets the frequency counter gate time*.
ARB edit keys		Arbitrary waveform editing keys. The Point key sets the ARB point numbers. The Value key sets the amplitude value of the selected point.
Function keys		The FUNC key is used to select the output waveform type: Sine, Square, Ramp, Noise, ARB.
		Sets the frequency of the selected waveform.
		Sets the amplitude of the selected waveform.
		The OFST sets the DC offset for the selected waveform.
		The DUTY key sets the duty cycle of square and ramp waveforms.
*indicates functions/features for the FGX-2112 only.		

1-3. Rear Panel FGX-2112 Rear Panel

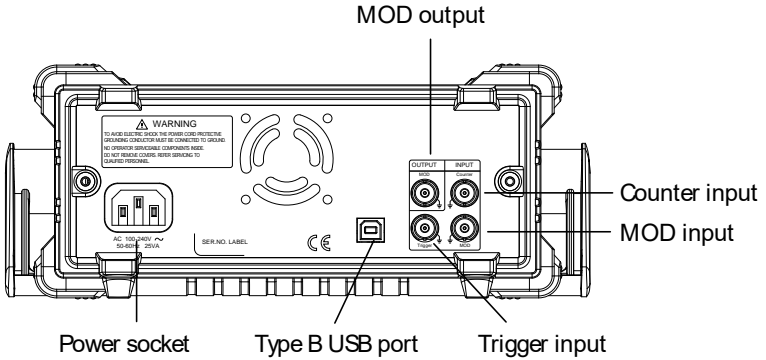

FGX-2005 Rear Panel

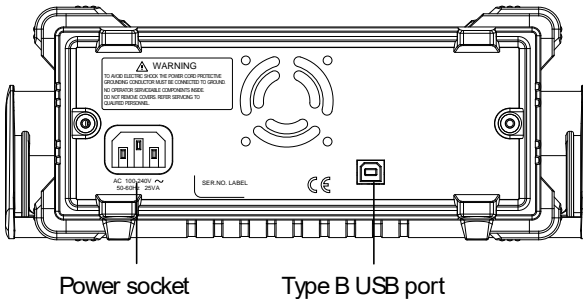

MOD output
Counter input
MOD input
Trigger input

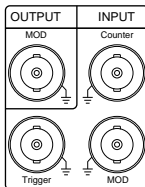

Modulation output port.
Counter input port.
Modulation input port.
Trigger input port.

Type B USB port



The type B USB port is used to connect the function generator to a PC for remote control.

Power Socket Input



Power input: 100~240V AC
50~60Hz.

AC 100-240V ~
50-60Hz 25VA

1-4. Display

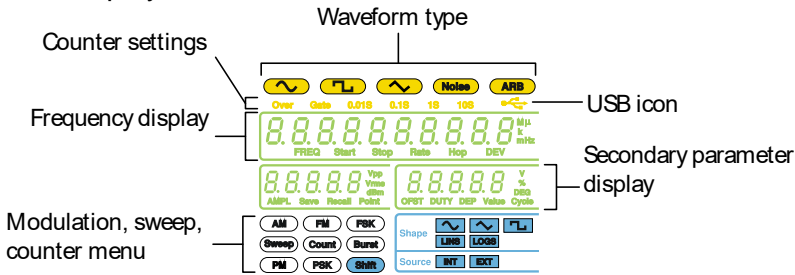

Waveform type



Press the function key to cycle through different output waveforms.

Counter settings



Gate time counter settings*.

USB icon



Frequency Display



Displays the main waveform frequency settings.

Secondary parameter display



Displays secondary waveform parameters and settings.

Modulation, sweep, counter menu

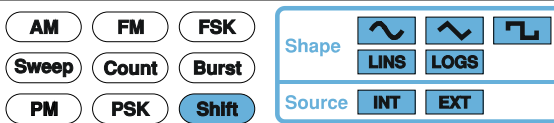

Displays the modulation, sweep and counter functions as well as the modulating waveform and source*.

*indicates functions/features for the FGX-2112 only.

1-5. Setting up the Function Generator

Background This section describes how adjust the handle and power up the function generator.

Adjusting the stand Pull out the handle sideways and rotate it.

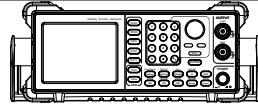

Place the FGX horizontally.

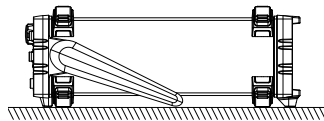

Place the handle upright to tilt the stand.

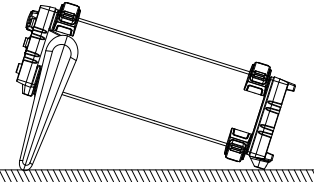

Place the handle vertically to hand carry.

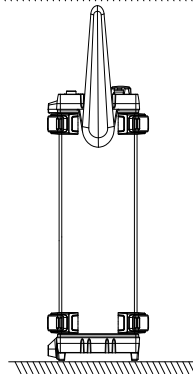

Power Up

1. Connect the power cord to the socket on the rear panel.

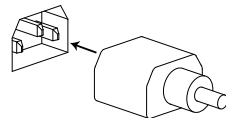

2. Press the power button on the front panel.



3. The instrument will turn on and load the last settings that were used before the power was turned off.



The function generator is now ready to be used.

2. QUICK REFERENCE

This chapter lists operation shortcuts and default factory settings. Use this chapter as a handy reference for instrument functions. This chapter is to be used as a quick reference; for detailed explanations on parameters, settings and limitations, please see the operation chapter (page 17) or specifications (page 85).

2-1. How to use the Digital Inputs

Background

The FGX-2000 has three main types of digital inputs: the number pad, arrow keys and the scroll wheel. The following instructions will show you how to use the digital inputs to edit parameters.

1. First select the function that must be edited pressing one of the function or ARB keys. The selected function will flash.

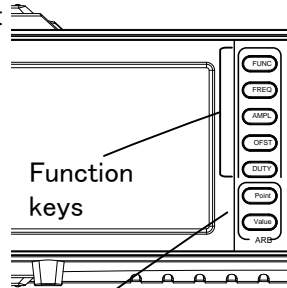

2. To edit a parameter, use the arrow keys to move the cursor to the digit that needs to be edited.



3. Use the scroll wheel to increment the parameter by the resolution of the digit under the cursor. In the example above, the scroll wheel will increment the parameter in 0.1 volt increments. Clockwise increases the value, counterclockwise decreases the value.

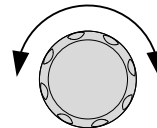

- Press the Enter key to confirm the new parameter value.



- Alternatively, the number pad can be used to set the value of the selected parameter.

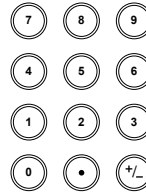

- To finish editing with the number pad, select the unit with one of the unit keys. (Hz, kHz, MHz, Vpp, Vrms, dBm, %)



2-2. Selecting a Waveform

2-2-1. Sine Wave

Example: Sine Wave, 10kHz, 1Vpp, 2Vdc

Output

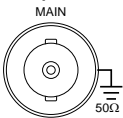

- Press the **FUNC** key repeatedly to select the Sine wave.



- Press **FREQ > 1 > 0 > kHz**.



- Press **AMPL > 1 > Vpp**.



- Press **OFST > 2 > Vpp**.



- Press the **OUTPUT** key.



2-2-2. Square Wave

Example: Square Wave, 10kHz, 3Vpp, 75% duty cycle

Output

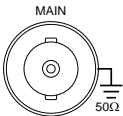

- Press the **FUNC** key repeatedly to select the Square wave.



- Press **FREQ > 1 > 0 > kHz**.



- Press **AMPL > 3 > Vpp**.



- Press **DUTY > 7 > 5 > %**.



5. Press the output key.



2-2-3. Ramp Wave

Example: Ramp Wave, 10kHz, 3Vpp, 25% symmetry

Output

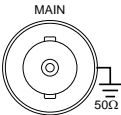

1. Press the **FUNC** key repeatedly to select the Ramp wave.



2. Press **FREQ > 1 > 0 > kHz.**



3. Press **AMPL > 3 > Vpp.**



4. Press **DUTY > 2 > 5 > %.**



5. Press the **OUTPUT** key.



2-3. ARB

Example: 2 ARB points, 10 kHz, 1Vpp.

Output

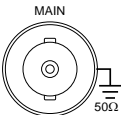

1. Press the **FUNC** key repeatedly to select the ARB wave.



2. Press **FREQ > 1 > 0 > kHz.**



3. Press **AMPL > 1 > Vpp.**



4. Press **Point > 0 > Enter.**



5. Press **Value > 5 > 1 > 1 > Enter.**



6. Press **Point > 1 > Enter.**



7. Press **Value > ± > 5 > 1 > 1 > Enter.**
(-511)

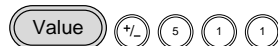

8. Press the **OUTPUT** key.











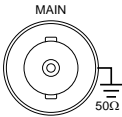























2-4. Modulation

2-4-1. AM (FGX-2112 only)

Example: AM modulation. 100Hz modulating square wave. 1 Vpp, 1kHz Sine wave carrier. 70% modulation depth. Internal source signal.

Output









1. Press the **FUNC** key repeatedly to select the Sine wave.   → 
2. Press **FREQ > 1 > kHz**.   
3. Press **AMPL > 1 > Vpp**.   
4. Press **AM**. 
5. Press **Shift > INT/EXT >** select **INT** source.  +  
6. Press **Shift > Shape** repeatedly to select the **Square wave**.  +   → 
7. Press **Shift > Rate > 1 > 0 > 0 > Hz**.  +      
8. Press **Shift > DEP/DEV > 7 > 0 > %**.  +     
9. Press the **OUTPUT** key. 
10. Press **AM** again to deselect the AM function. 

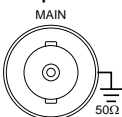



2-4-2. FM (FGX-2112 only)

Example: FM modulation. 100Hz modulating square wave. 1Vpp, 1kHz Sine wave carrier. 100 Hz frequency deviation. Internal Source.

Output

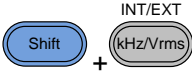
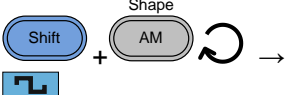
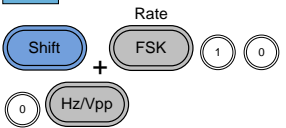
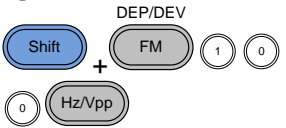

1. Press the **FUNC** key repeatedly to select the Sine wave.   → 
2. Press **FREQ > 1 > kHz**.   





3. Press **AMPL > 1 > Vpp.** 
4. Press **FM.** 
5. Press **Shift > INT/EXT >**
select **INT** source. 
6. Press **Shift > Shape**
repeatedly to select
Square wave. 
7. Press **Shift > Rate > 1 >**
0 > 0 > Hz. 
8. Press **Shift >**
DEP/DEV > 1 > 0 > 0 >
Hz 
9. Press the **OUTPUT** key. 
10. Press **FM** again to
deselect the AM
function. 

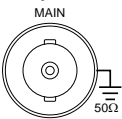

2-4-3. FSK Modulation (FGX-2112 only)

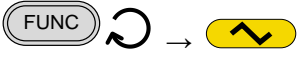
Example: FSK modulation. 10Hz Hop frequency. 1Vpp, 1kHz Ramp carrier wave. 100 Hz Rate (modulation frequency). Internal Source.

Output

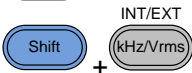
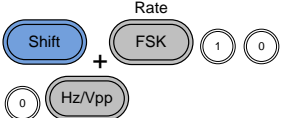

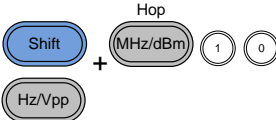
1. Press the **FUNC** key
repeatedly to select the
Ramp wave. 
2. Press **FREQ > 1 > kHz.** 
3. Press **AMPL > 1 > Vpp.** 
4. Press **FSK.** 
5. Press **Shift > INT/EXT >**
select **INT** source. 
6. Press **Shift > Rate > 1 >**
0 > 0 > Hz. 





7. Press **Shift > Hop > 1 > 0 > Hz.**

8. Press the **OUTPUT** key.
 
9. Press **FSK** again to deselect the FSK function.
 

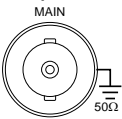
2-5. Sweep (FGX-2112 only)

Example: Frequency Sweep. Start Frequency 1Hz, Stop Frequency 1MHz. 1Hz Rate. 1Vpp. Linear Sweep.

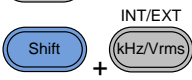
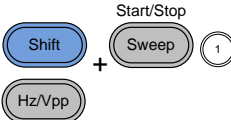
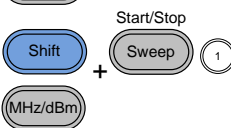
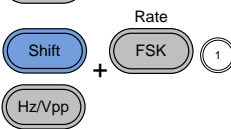
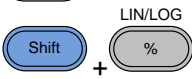
Output







1. Press the **FUNC** key repeatedly to select the **Ramp** wave.
 
2. Press **AMPL > 1 > Vpp.**

3. Press **Sweep.**

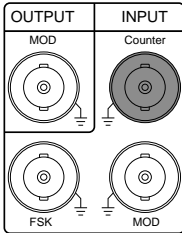
4. Press **Shift > INT/EXT >** select **INT** source.
 
5. Press **Shift > Start/Stop** select **Start > 1 > Hz.**

6. Press **Shift > Start/Stop** select **Stop > 1 > MHz.**

7. Press **Shift > Rate > 1 > Hz.**

8. Press **Shift > LIN/LOG >** select **LINS.**

9. Press the **OUTPUT** key.
 
10. Press **Sweep** again to deselect the sweep function.
 

2-6. Counter (FGX-2112 only)

Example: Frequency counter function, gate time 1s.

Input





1. Press the **Count** key. 
2. Press **Shift > Gate** repeatedly to select the **1S** gate time.  + 
3. Connect the signal to the counter input signal.
4. Press **Count** again to deselect the counter function. 

2-7. Save/Recall

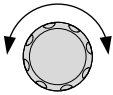
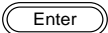

2-7-1. Save

Example: Save waveform to memory.

1. Press **Shift > Save/Recall**. Select **Save**.  + 
2. Turn the scroll wheel and choose a save number. 
3. Press **Enter** to confirm the save file number. 

2-7-2. Recall

Example: Recall waveform from memory.

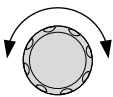
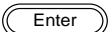
1. Press **Shift > Save/Recall**. Select **Recall**.  + 
2. Turn the scroll wheel and choose a saved file number. 
3. Press Enter to confirm the recall. 

2-8. Default Settings

The default settings can be loaded by using the *RST command or pressing the following keys: Duty, 1, 2, 3, 4, 8, Enter

Output Config.	Function	Sine wave
	Frequency	1kHz
	Amplitude	100mVpp
	Offset	0.00Vdc
	Output units	Vpp
	Output terminal	50Ω
	Load impedance	50Ω
Modulation (AM/FM/FSK)	Carrier Wave	1kHz Sine wave
	Modulation waveforms	100Hz Sine wave
	AM Depth	100%
	FM Deviation	10Hz
	FSK Hop Frequency	100Hz
	FSK Frequency	500Hz
	Modulation Status	Off
Sweep	Start/Stop frequency	100Hz/1kHz
	Sweep time	1s
	Sweep rate	100Hz
	Sweep type	Linear
	Sweep status	Off
System settings	Power off signal	On
	Display mode	On
	Error queue	cleared
	Memory settings (ARB)	No change
	Output	Off
Interface config.	USB	CDC
Calibration	Calibration Menu	Restricted

3. OPERATION

The Operation chapter shows how to output basic waveforms and create ARB waveforms. The FGX-2112 can also perform advanced functions such as modulation, sweep, FSK and counter functions.

3-1. Select a Waveform

The FGX-2000 can output four standard waveforms: sine, square, ramp and noise waveforms.

- Panel Operation
1. Press the **FUNC** key repeatedly to select a standard waveform (Sine, Square, Ramp, Noise).



Example:
Sine wave

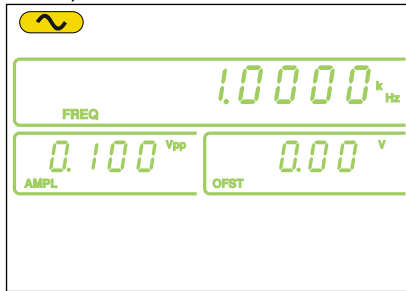

The modulation, FSK, sweep and counter functions must be disabled before a standard waveform can be output.

3-2. Setting the Frequency

- Panel Operation
- Press the **FREQ** key.



The **FREQ** icon will flash in the frequency display area.



Use the arrow keys, scroll wheel and Enter key to edit the frequency.

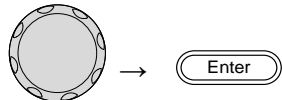

Use the keypad and the relevant unit key to enter a new frequency.

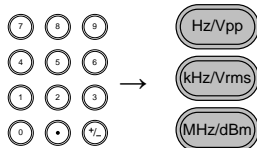

Range	Sine	0.1Hz ~ 12MHz*
	Square	0.1Hz ~ 12MHz*
	Ramp	0.1Hz ~ 1MHz
*limited to 5MHz for the FGX-2005, 12MHz for the FGX-2112.		

Example:
FREQ = 1kHz

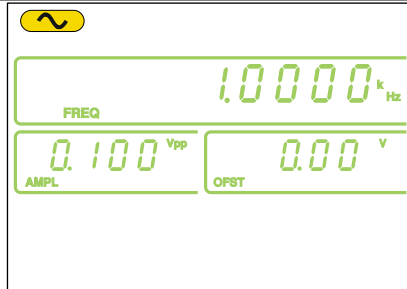

3-3. Setting the Amplitude

Panel Operation

1. Press the **AMPL** key.



2. The AMPL icon will flash in the secondary display area.



3. Use the **arrow keys**, **scroll wheel** and **Enter** key to edit the amplitude.

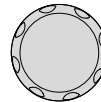

Use the **keypad** and the relevant **unit** key to enter a new amplitude.

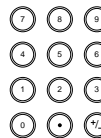

Range	No load	2mVpp~20Vpp
	50Ω Load	1mVpp~10Vpp

Example:
 AMPL= 1Vpp

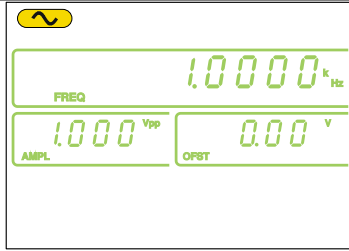

3-4. Setting the DC Offset

Panel Operation

1. Press the **OFST** key.



2. The OFST icon will flash in the secondary display area.



3. Use the **arrow keys**, **scroll wheel** and **Enter** key to edit the offset.

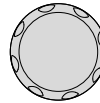

Use the **keypad** and the **Vpp** key to enter a new offset.



Range

No Load (AC+DC)

± 10 Vpk

50 Ω Load (AC+DC)

± 5 Vpk

Example:

OFST= 1VDC

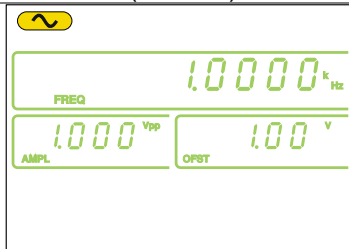

3-5. Setting the Duty Cycle/Symmetry

Background

The DUTY key sets the duty cycle or symmetry of the standard square or ramp waveforms.

Panel Operation

1. Ensure a square or ramp waveform is selected. Page 17
2. Press the **DUTY** key. DUTY
3. The duty icon will flash in the secondary display area.



4. Use the **arrow keys**, **scroll wheel** and **Enter** key to edit the duty cycle/symmetry.

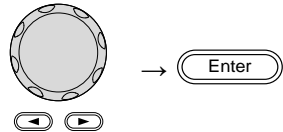

Use the **keypad** and the **%** key to enter a new duty cycle/symmetry.

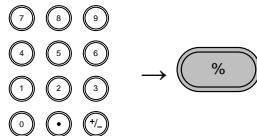

Duty Cycle Range

$\leq 100\text{kHz}$	1.0% ~ 99.0%
$\leq 5\text{MHz}$	20.0% ~ 80.0%
$\leq 10\text{MHz}$	40.0 ~ 60.0%
$\leq 12\text{MHz}$	50.0% (fixed)

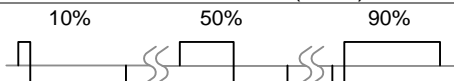

Symmetry Range

All frequencies 0% ~ 100%

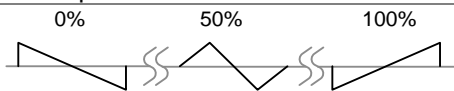

Example:
DUTY= 50.0%



3-6. Setting the Load Impedance

Background

The FGX-2000 load impedance can be set to 50Ω or to High-Z. When the load impedance is set to high-Z the effect output is doubled compared to the default 50Ω. For example, when the amplitude is set to 10Vpp (impedance of 50Ω) when the load impedance is switched to high-Z, the amplitude becomes 20Vpp.



Note

dBm units are not supported for the high-Z load impedance.

If the amplitude unit is dBm, and you switch to the High-Z load impedance, the amplitude unit will automatically change to Vpp.

If the load impedance is set to High-Z, you cannot set the amplitude units to dBm. Change the load impedance back to 50Ω first.

Panel Operation

1. To toggle the load impedance between 50 and High-Z, press

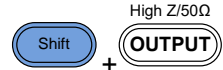

SHIFT+OUTPUT.

2. The selected load impedance will flash momentarily on the display.

50 Ω:



High-Z:



3-7. Turning the Output On

Panel Operation

1. Press the **OUTPUT** key to output the selected waveform. 
The output key will turn green when the output is on.



2. To disable the output, press the **OUTPUT** key again. 
The output key will turn off when the output is disabled.



3-8. Amplitude Modulation (AM) (FGX-2112)

An AM waveform is produced from a carrier waveform and a modulating waveform. The amplitude of the modulated carrier waveform depends on the amplitude of the modulating waveform. The FGX-2112 function generator can set the carrier frequency, amplitude and offset as well as internal or external modulation sources.

AM modulation is only applicable for the FGX-2112 function generators.

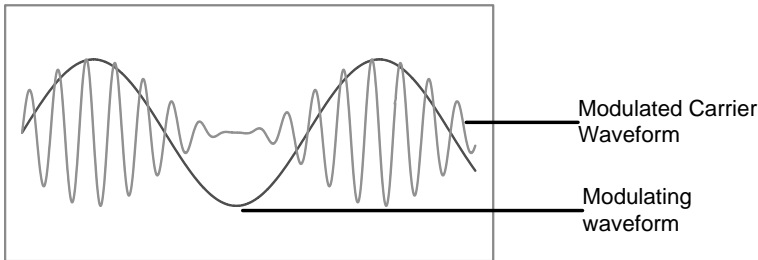

3-8-1. Selecting AM Modulation

Panel Operation

1. Press the **AM** key. 
2. The modulation, sweep and counter menu display will appear. The AM icon indicates that the AM function is active.



Example:
AM activated

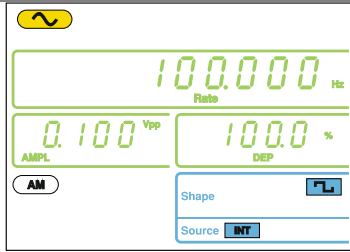

Note

AM modulation can be deactivated by pressing the **AM** key again.

3-8-2. AM Carrier Waveform

Background

The FUNC key selects the AM carrier waveform. Sine, square or ramp waveforms can be used as the carrier. The default waveform is set to sine. Noise is not available as a carrier shape. Before the carrier shape can be selected, ensure AM is active, page 38.

Selecting the Carrier Shape

1. Press the **FUNC** key repeatedly to select a carrier waveform (Sine, Square, Ramp).



Range

AM Carrier Shape sine, square, ramp

3-8-3. Setting the Carrier Frequency

Panel Operation

1. Press **FREQ** key.



2. The FREQ icon will flash in the frequency display area.



3. Use the **arrow keys**, **scroll wheel** and **Enter** key to edit the frequency.

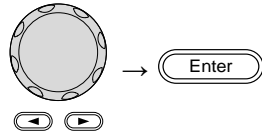

Use the **keypad** and the relevant **unit** key to enter a new frequency.

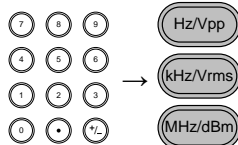

Range	Sine	0.1Hz ~ 12MHz
	Square	0.1Hz ~ 12MHz
	Ramp	0.1Hz ~ 1MHz

Example:
FREQ = 1kHz

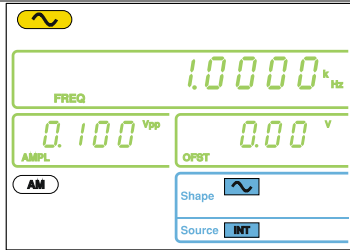

3-8-4. Setting the Carrier Amplitude

Panel Operation

1. Press **AMPL** key. 
2. The AMPL icon will flash in the secondary display area.



3. Use the **arrow keys**, **scroll wheel** and **Enter** key to edit the amplitude.

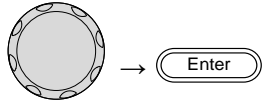

Use the **keypad** and the relevant **unit** key to enter a new amplitude.

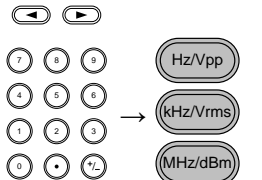

Range	No Load	2mVpp~20Vpp
	50Ω Load	1mVpp~10Vpp

Example:
AMPL= 1Vpp

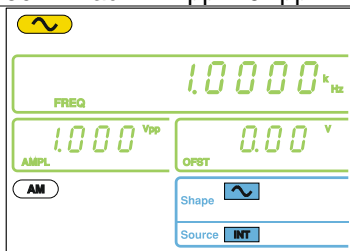

3-8-5. Setting the Modulating Wave Shape

The FGX-2112 has sine, square and Triangle modulating waveform shapes. Sine waves are the default wave shape.

Panel Operation

1. Press the **Shift + Shape** key repeatedly to select a shape waveform.

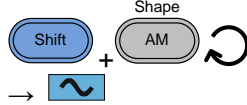

2. The waveform Shape is displayed in blue at the bottom of the panel.



Restrictions

Square 50% duty cycle
Triangle 50% symmetry

Example:
Shape = Sine

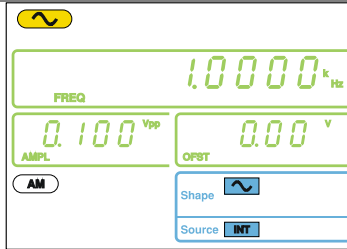

3-8-6. Setting the Modulation Frequency (Rate)

Panel Operation

1. Press the **Shift + Rate** key.

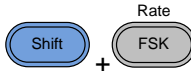

2. The Rate icon will flash in the frequency display area.



3. Use the **arrow keys, scroll wheel** and **Enter** key to edit the rate.

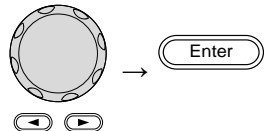

Use the **keypad** and the relevant **unit** key to enter a new rate.

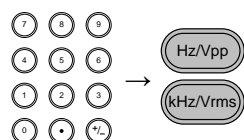

Range	(Internal source) 2mHz ~ 20kHz
	Default 100Hz

Example:
Rate= 100Hz

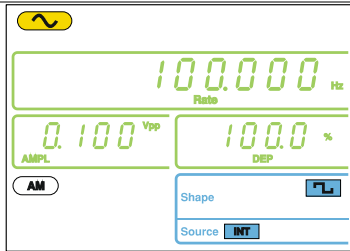

3-8-7. Modulation Depth

Modulation depth is the ratio (as a percentage) of the unmodulated carrier amplitude and the minimum amplitude deviation of the modulated waveform. In other words, modulation depth is the maximum amplitude of the modulated waveform compared to the carrier waveform as a percentage.

Panel Operation

1. Press the **Shift + DEP/DEV** key.

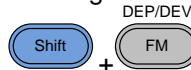

2. The DEP icon will flash in the secondary display area.



3. Use the **arrow keys, scroll wheel** and **Enter** key to edit the modulation depth.

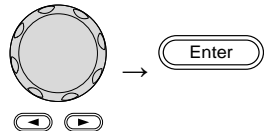

Use the **keypad** and the **%** key to enter a new depth.

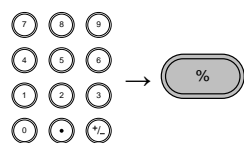

Range	Depth	0% ~ 120%
	Default	100%

Example:
DEP= 100%

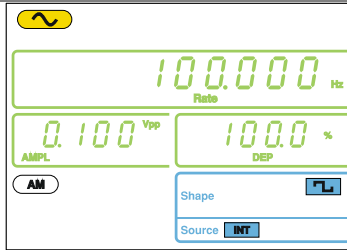

Note

When the modulation depth is greater than 100%, the output cannot exceed $\pm 5V_{Peak}$ (50 Ω load).
If an external modulation source is selected, modulation depth is limited to $\pm 5V$ from the MOD input port on the rear panel. For example, if the modulation depth is set to 100%, then the maximum amplitude is +5V, and the minimum amplitude is -5V.

3-8-8. Setting the Modulation Source

Panel Operation

1. Press the **Shift + INT/EXT** key to select the modulation source.

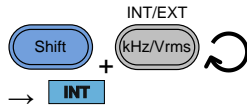

2. The modulation source will be displayed at the bottom of the screen.



Note

If an external modulation source is selected, modulation depth is limited to $\pm 5V$ from the MOD input port on the rear panel. For example, if the modulation depth is set to 100%, then the maximum amplitude is +5V, and the minimum amplitude is -5V.

Example:
Source = INT

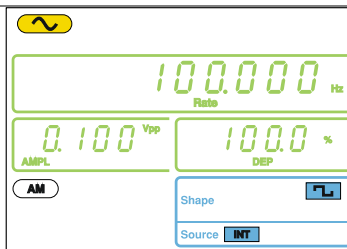

Example:
External MOD
input signal

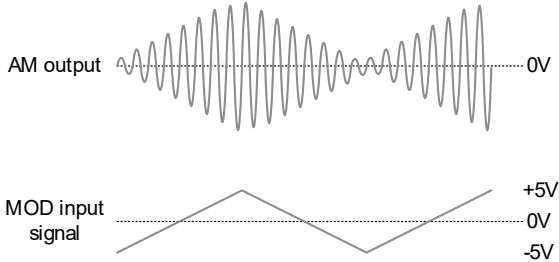

3-9. Frequency Modulation (FM)(FGX-2112)

An FM waveform is produced from a carrier waveform and a modulating waveform. The instantaneous frequency of the carrier waveform varies with the magnitude of the modulating waveform. FM modulation is only applicable to the FGX-2112.

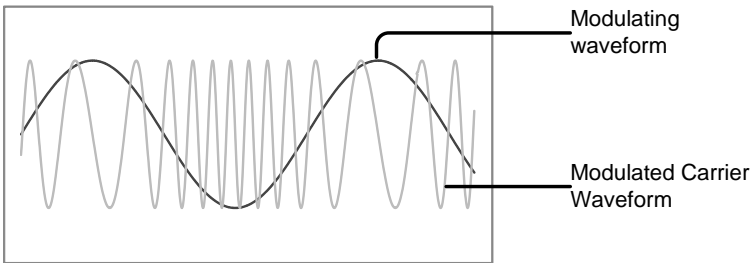

3-9-1. Selecting FM Modulation

Panel Operation

1. Press the **FM** key. 
2. The modulation, sweep and counter menu display will appear. The FM icon indicates that the FM function is active.



Example:
FM activated

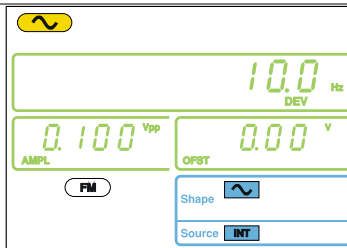



Note

FM modulation can be deactivated by pressing the **FM** key again.

3-9-2. FM Carrier Waveform

Background The FUNC key selects the FM carrier waveform. Sine, square or ramp waveforms can be used as the carrier. The default waveform is set to sine. Noise is not available as a carrier shape. Before the carrier shape can be selected, ensure FM is active, page 28.

Selecting the Carrier Shape

1. Press the **FUNC** key repeatedly to select a carrier waveform (Sine, Square, Ramp).



Range FM Carrier Shape sine, square, ramp

3-9-3. Setting the Carrier Frequency

Background When using the FGX-2112 function generator, the carrier frequency must be equal to or greater than the frequency deviation.

Panel Operation

1. Press **FREQ** key.



2. The FREQ icon will flash in the frequency display area.



3. Use the **arrow keys**, **scroll wheel** and **Enter** key to edit the frequency.

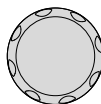

Use the **keypad** and the relevant **unit** key to enter a new frequency.

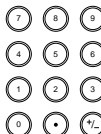

Range	Sine	0.1Hz ~ 12MHz
	Square	0.1Hz ~ 12MHz
	Ramp	0.1Hz ~ 1MHz

Example:
 FREQ = 1kHz

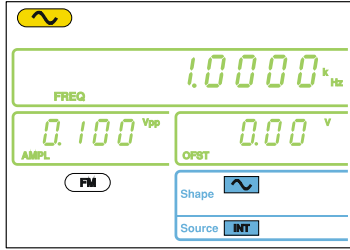

3-9-4. Setting the Carrier Amplitude

Panel Operation

1. Press **AMPL** key. 
2. The AMPL icon will flash in the secondary display area.



3. Use the **arrow keys**, **scroll wheel** and **Enter** key to edit the amplitude.

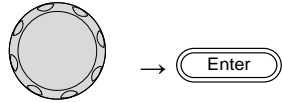

Use the **keypad** and the relevant **unit** key to enter a new amplitude.

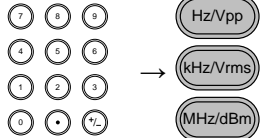

Range	No Load	2mVpp~20Vpp
	50Ω load	1mVpp~10Vpp

Example:
 AMPL= 1Vpp

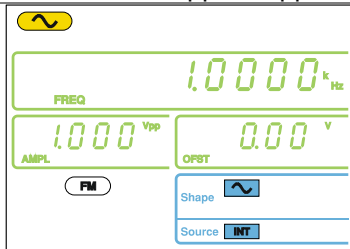

3-9-5. Setting the Modulating Wave Shape

The FGX-2112 has sine, square and Triangle modulating waveform shapes. Sine waves are the default wave shape. The modulating wave shape is for internal sources only.

Panel Operation

1. Press the **Shift + Shape** key repeatedly to select a shape waveform.

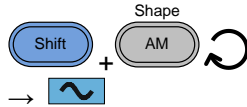

2. The waveform Shape is displayed in blue at the bottom of the panel.

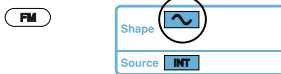

Restrictions

Square 50% duty cycle
Triangle 50% symmetry

Example:
Shape = Sine

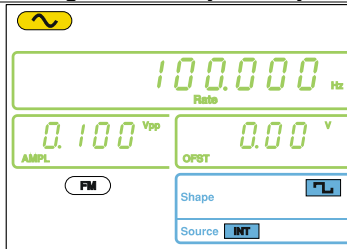

3-9-6. Setting the Modulation Frequency (Rate)

Panel Operation

1. Press the **Shift + Rate** key.

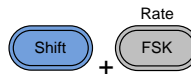

2. The Rate icon will flash in the frequency display area.



3. Use the **arrow keys, scroll wheel** and **Enter** key to edit the rate.

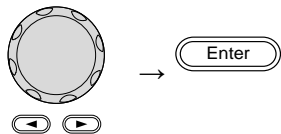

Use the **keypad** and the relevant **unit** key to enter a new rate.

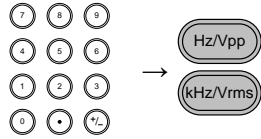

Range	(Internal source) 2mHz ~ 20kHz
	Default 100Hz

Example:
Rate= 100Hz

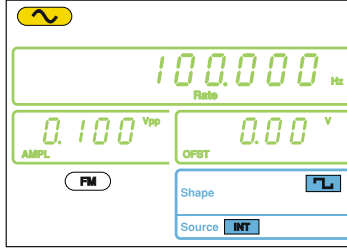

3-9-7. Frequency Deviation

The frequency deviation is the peak frequency deviation from the carrier wave and the modulated wave.

Panel Operation

1. Press the **Shift + DEP/DEV** key.

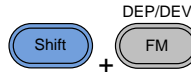

2. The DEV icon will flash in the frequency display area.

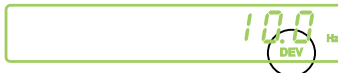

3. Use the **arrow keys, scroll wheel** and **Enter** key to edit the frequency deviation.

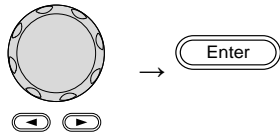

Use the **keypad** and the relevant **unit** key to enter a new frequency deviation.

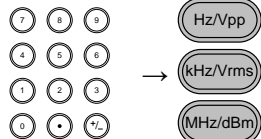

Range	Sine	DC ~ 12MHz
	Square	DC ~ 12MHz
	Ramp	DC ~ 1MHz
	Default	10Hz



Note

The frequency deviation must be equal to or less than the carrier frequency.
 The sum of the carrier frequency and frequency deviation must be less than or equal to the maximum carrier.
 The maximum frequency deviation allowed will be limited by the set carrier frequency.

Example:
 DEV = 10Hz

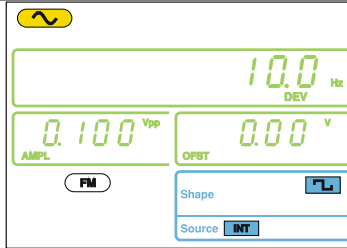

3-9-8. Setting the Modulation Source

Panel Operation

1. Press the **Shift + INT/EXT** key to select the modulation source.

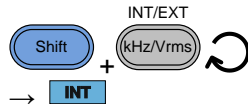

2. The modulation source will be displayed at the bottom of the screen.



Range

Source

INT, EXT

Connection
 (EXT source only)

For external sources, connect the modulation source signal to the MOD input port on the rear panel.

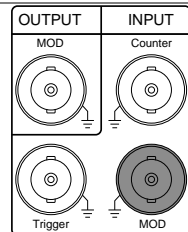

Note

When the source is set to EXT (external) the carrier waveform is modulated by an external signal. The frequency deviation is controlled by the $\pm 5V$ signal that is input into the MOD input port. The $\pm 5V$ input signal directly corresponds to the set frequency deviation. +5V increases the frequency by the set deviation frequency and -5V reduces the frequency to below the carrier frequency by the amount set by

the deviation frequency. For example: if the deviation frequency is set to 1kHz, an input voltage of +5V will increase the frequency to 1kHz, whilst an input voltage of -5V will reduce the frequency below that of the carrier by 1kHz.

Example:
Source = INT

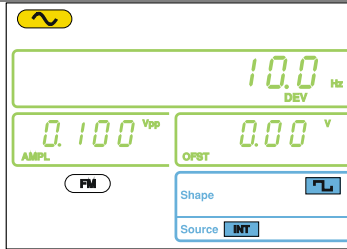

Example:
External MOD
input signal

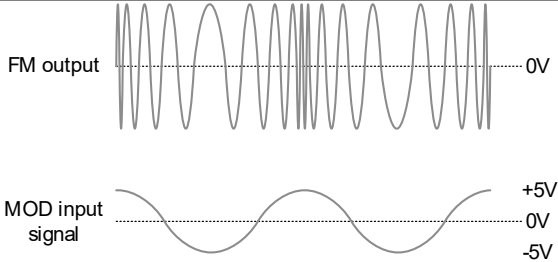

3-10. Frequency Shift Keying (FSK) Modulation (FGX-2112)

Frequency Shift Keying Modulation is used to shift the frequency output of the function generator between two preset frequencies (carrier frequency, hop frequency). The frequency at which the carrier and hop frequency shift is determined by the rate setting or the voltage level from the Trigger input port on the rear panel.

FSK modulation is only applicable to the FGX-2112.

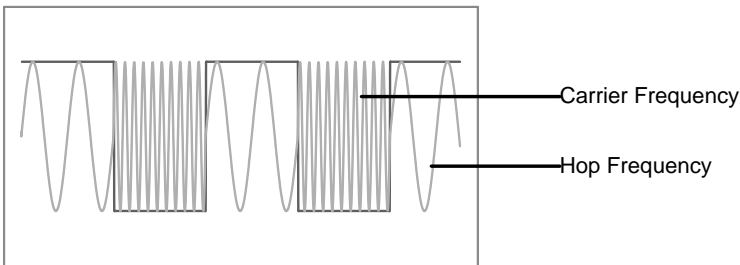

3-10-1. Selecting FSK Modulation

- Panel Operation
1. Press the **FSK** key. 
 2. The modulation, sweep and counter menu display will appear. The FSK icon indicates that the FSK function is active.

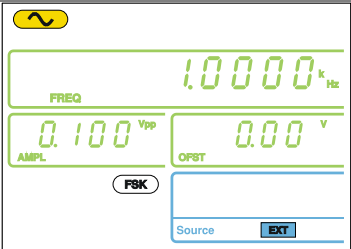

Example:
FSK activated



 **Note** FSK modulation can be deactivated by pressing the **FSK** key again.

3-10-2. FSK Carrier Waveform

Background The FUNC key selects the FSK carrier waveform. Sine, square or ramp waveforms can be used as the carrier. The default waveform is set to sine. Noise and ARB cannot be used as a carrier wave.

- Selecting the Carrier**
1. Press the **FUNC** key repeatedly to select a carrier waveform (Sine, Square, Ramp).   →

Range FSK Carrier sine, square, ramp
Shape

3-10-3. FSK Carrier Frequency

The maximum carrier frequency depends on the carrier shape. The default carrier frequency for all carrier shapes is 1kHz. The voltage level of the Trigger input port controls the output frequency when EXT is selected as the source. When the Trigger input signal is logically low, the carrier frequency is output and when the signal is logically high, the hop frequency is output.

- Panel Operation
1. Press **FREQ** key. 

- The FREQ icon will flash in the frequency display area.



- Use the **arrow keys, scroll wheel** and **Enter** key to edit the frequency.

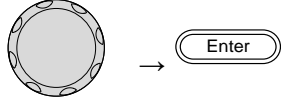

Use the **keypad** and the relevant **unit** key to enter a new frequency.

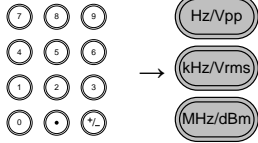

Range	Sine	0.1Hz ~ 12MHz
	Square	0.1Hz ~ 12MHz
	Ramp	0.1Hz ~ 1MHz

Example:
FREQ = 1kHz

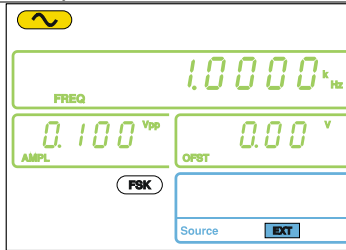

3-10-4. Setting the Carrier Amplitude

- Panel Operation
- Press **AMPL** key.



- The AMPL icon will flash in the secondary display area.



- Use the **arrow keys, scroll wheel** and **Enter** key to edit the amplitude.

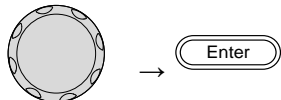

Use the **keypad** and the relevant **unit** key to enter a new amplitude.

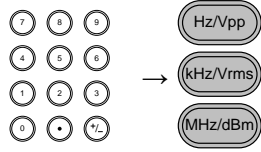

Range	No Load	2mVpp~20Vpp
	50Ω Load	1mVpp~10Vpp

Example:
AMPL= 1Vpp

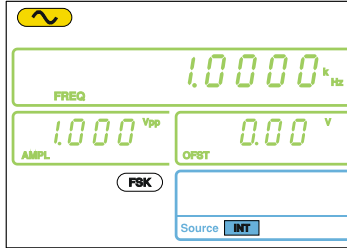

3-10-5. Setting the Hop Frequency

The default Hop frequency for all waveform shapes is 100 Hz. A square wave with a duty cycle of 50% is used for the internal modulation waveform. The voltage level of the Trigger input signal controls the output frequency when EXT is selected. When the Trigger input signal is logically low the carrier frequency is output and when the signal is logically high, the hop frequency is output.

Panel Operation 1. Press the **Shift + Hop** key.

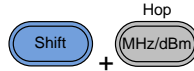

2. The Hop icon will flash in the frequency display area.



3. Use the **arrow keys**, **scroll wheel** and **Enter** key to edit the hop frequency.

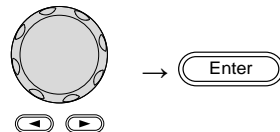

Use the **keypad** and the relevant **unit** key to enter a hop frequency.

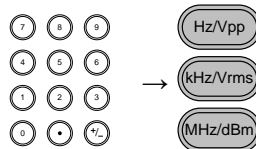

Range	Sine	0.1Hz ~ 12MHz
	Square	0.1Hz ~ 12MHz

Ramp
Default 0.1Hz ~ 1MHz
100Hz

Example:
Hop = 100Hz

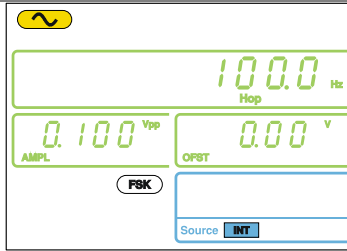

3-10-6. FSK Rate

FSK Rate function is used to determine the rate at which the output frequency changes between the carrier and hop frequencies. The FSK Rate function only applies to internal FSK sources.

Panel Operation 1. Press the **Shift + Rate** key.

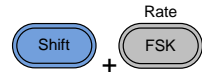

2. The Rate icon will flash in the frequency display area.



3. Use the **arrow keys**, **scroll wheel** and **Enter** key to edit the rate.

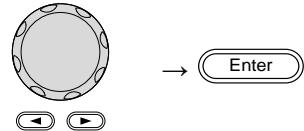

Use the **keypad** and the relevant **unit** key to enter a new rate.

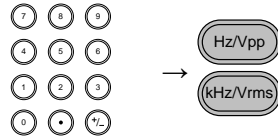

Range (Internal source) 2mHz ~ 20kHz
Default 100Hz

Example:
Rate= 1KHz

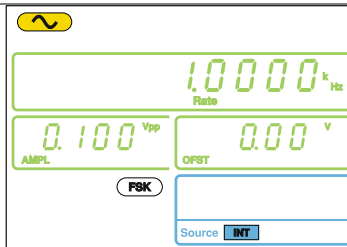

3-10-7. Setting the FSK Source

The FGX-2000 accepts internal and external FSK sources, with internal as the default source. When the FSK source is set to internal, the FSK rate is configured using the FSK Rate function. When an external source is selected the FSK rate is equal to the frequency of the Trigger input signal on the rear panel. When the input signal is logically low the carrier frequency is output and when the signal is logically high, the hop frequency is output.

Panel Operation

1. Press the **Shift + INT/EXT** key to select the modulation source.

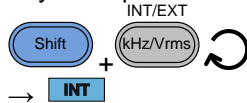

2. The FSK source will be displayed at the bottom of the screen.



Range	Source	INT, EXT
Connection (EXT source only)	For external sources, connect the FSK rate source signal to the Trigger input port on the rear panel.	

Example:
Source = EXT

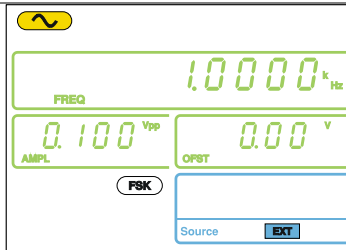

Example:
External trigger input signal

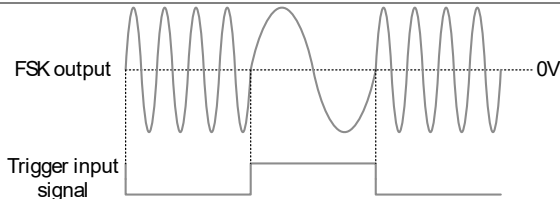

3-11. Frequency Sweep (FGX-2112)

The function generator can perform a sweep for sine, square or ramp waveforms, but not noise, and ARB. In Sweep mode, the function generator will sweep from a start frequency to a stop frequency over a number of designated steps. If an external source is selected, the function generator can be used to output a single sweep each time a TTL level pulse is received from the Trigger input port. The step spacing of the sweep can be linear or logarithmic. The function generator can also sweep up or sweep down in frequency. The Sweep function only applies to the FGX-2112.

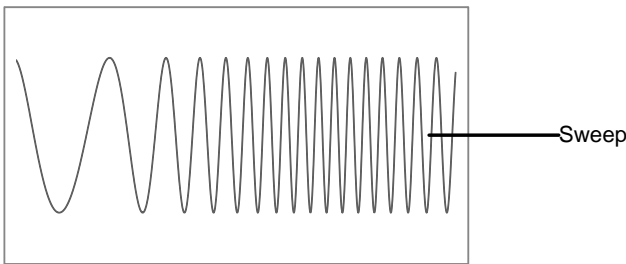

3-11-1. Selecting Sweep

Panel Operation

1. Press the **Sweep** key. 
2. The modulation, sweep and counter menu display will appear. The Sweep icon indicates that the Sweep function is active.

Example:
Sweep activated

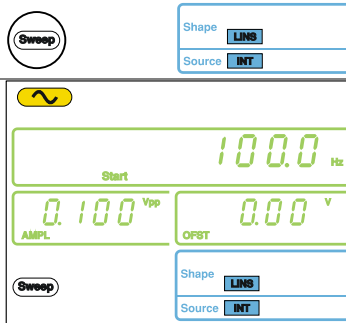

Sweep modulation can be deactivated by pressing the **Sweep** key again.

3-11-2. Setting Start and Stop Frequency

The start and stop frequencies define the upper and lower sweep limits. The function generator will sweep from the start through to the stop frequency and cycle back to the start frequency. The sweep is phase continuous over the full sweep range.

Panel Operation

1. Pressing the **Shift + Start/Stop** key will toggle between the start and stop frequencies. Select the **Start** frequency icon.

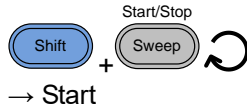

2. The Start icon will flash in the frequency display area when selected.



3. Use the **arrow keys, scroll wheel** and **Enter** key to edit the start frequency.

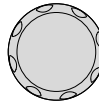

Use the **keypad** and the relevant **unit** key to enter a new start frequency.



Range	Sine	0.1Hz ~ 12MHz
	Square	0.1Hz ~ 12MHz
	Ramp	0.1Hz ~ 1MHz
	Default	Start: 100Hz, Stop: 1kHz

4. Repeat steps 1 to 3 for the Stop frequency.



Note

To sweep from a low to high frequency, set the Start frequency < Stop frequency.

To sweep from a high to low frequency, set the Start frequency > Stop frequency.

Example:
Start = 100Hz

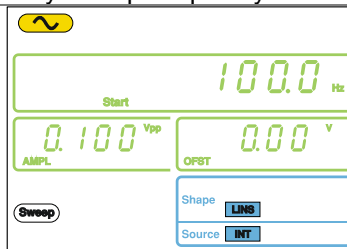

Example:
Stop = 1kHz

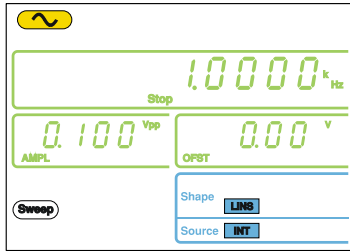

3-11-3. Sweep Mode

Sweep mode is used to select between linear or logarithmic sweeping. Linear sweeping is the default setting.

Panel Operation

1. Press the **Shift + LIN/LOG** key to select linear (LINS) or logarithmic (LOGS) sweeps.

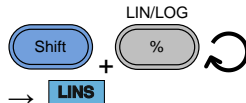

2. The LINS or LOGS icon will be displayed at the bottom of the screen.



Example:
Sweep = LINS

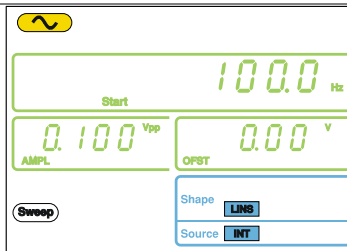

3-11-4. Sweep Rate

The sweep rate is used to determine how long it takes to perform a sweep from the start to stop frequencies. The function generator automatically determines the number of discrete frequencies used in the scan depending on the length of the scan.

Panel Operation

1. Press the **Shift + Rate** key.

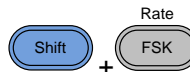

2. The Rate icon will flash in the frequency display area.



3. Use the **arrow keys, scroll wheel** and **Enter** key to edit the rate.

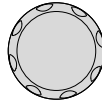

- Use the **keypad** and the relevant **unit** key to enter a new rate.

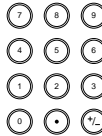

Range	Sweep Rate	1kHz ~ 2MHz (1ms ~ 500s)
	Default	100Hz

Example:
Rate= 100Hz

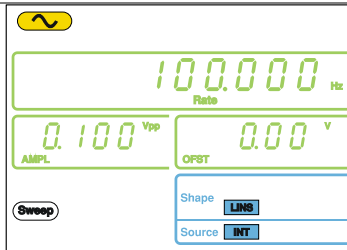

3-11-5. Setting the Sweep Source (Trigger)

With the source set to EXT, the function generator will sweep each time a trigger signal is received. After a sweep output has completed, the function generator waits for a trigger signal before starting the next sweep. The default trigger source is internal.

Panel Operation

1. Press the **Shift + INT/EXT** key to select the modulation source.

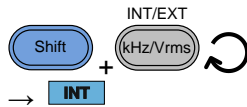

2. The Trigger source will be displayed at the bottom of the screen.



Range	Source	INT, EXT
-------	--------	----------

Connection
(EXT source
only)

For external sources, connect the Sweep trigger signal to the Trigger input port on the rear panel.

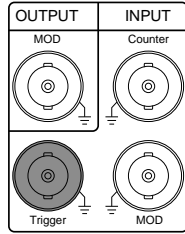

Example:
Source = EXT

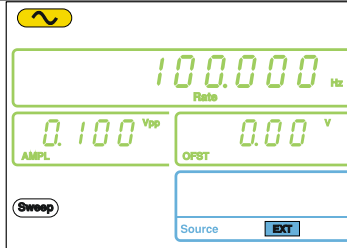

Note

With an external source, a sweep is output each time a trigger pulse (TTL) is received from the Trigger input port on the rear panel.

The trigger frequency must be greater than the sweep rate (sweep time) plus 125nS (trigger pulse width > 125nS).



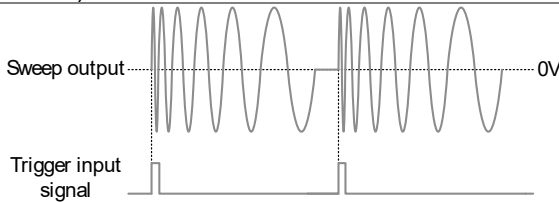

Example:
External trigger
input signal



3-12. Creating an Arbitrary Waveform

Both the FGX-2000 has a simple arbitrary waveform editing function. The ARB function is able to create waveforms with a 20MHz sampling rate, 4k data points with vertical range of ± 511 points.

Selecting the
Carrier Shape

1. Press the **FUNC** key repeatedly to select the ARB function.   
2. Press the **Point** key. 
3. Point will flash in the secondary display area.



4. Use the **scroll wheel** or **keypad** to choose a point number.

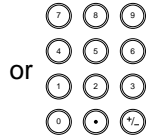
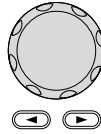

Use the **Enter** key to confirm the point number.



Range Point: 0 ~ 4096

5. Press the **Value** key.



6. Value will flash in the secondary display area.



7. Use the **scroll wheel** or **keypad** to choose the vertical value of the selected point.

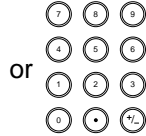
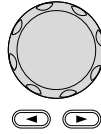

Use the **Enter** key to confirm the point value.

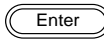

Range Value: ± 511 (10-bit vertical resolution)

8. Repeat steps 2 to 7 for the remaining points of the ARB waveform.



Note

The horizontal position of the points depends on the set frequency. For example, if the set frequency is 1kHz (period = 1ms), then each point will be located every 0.01ms (1ms/sample rate).

Example:
Point "0" is set to +511.

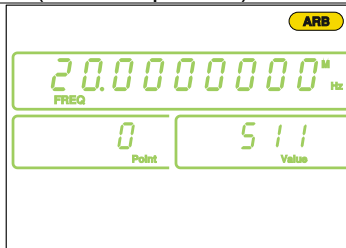

Note

To save the ARB data, please see the Save/Recall section on page.15

3-13. Using the Frequency Counter

3-13-1. Selecting the Frequency Counter Function

Connection Connect the signal source to Counter input port on the rear panel.

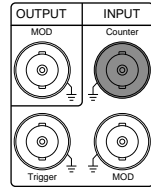

Panel Operation 1. Press the **Count** key.



2. The current gate time and the Count icon will appear in the display when the counter function is active. The input frequency will be shown in the frequency display area.

Example: input frequency of 1kHz

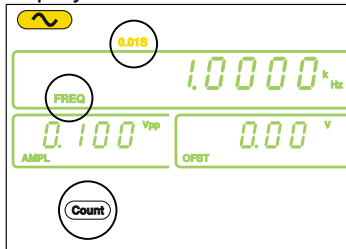

3-13-2. Selecting the Gate Time

- Panel Operation**
1. Ensure the Count function is active.
 2. Press the **Shift + Gate** key repeatedly to select the desired gate time.

Page 46

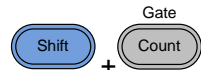

Range Gate time 0.01s, 0.1s, 1s, 10s

3. The current gate time is displayed in the counter settings area of the display.



3-14. Using the SYNC Output Port

3-14-1. Connecting the SYNC Output Port

Background The SYNC output port is used as a synchronization signal for function outputs. All the output signals apart from the noise output function have a synchronization signal.

Connection Connect a BNC cable from the SYNC output port on the front panel to the desired input device.

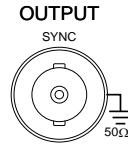

Note

The SYNC signal is output even when the main output is not output.

3-14-2. SYNC Output Signal

SYNC Output For Sine Wave SYNC output: TTL square waveform with a 50% duty cycle. The SYNC output is at a logically high level when the sine output is positive.

Output diagram

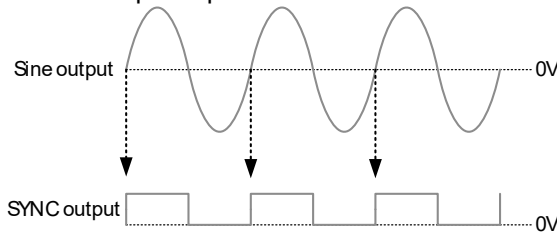

SYNC Output For Square Wave SYNC output: TTL square waveform with a duty cycle corresponding to the duty cycle of the output square wave. The SYNC output is at a logically high level when the square wave output is positive.

Output diagram

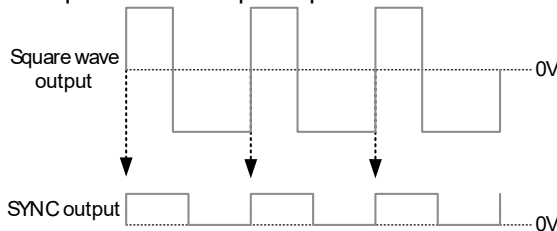

SYNC Output For Ramp Wave SYNC output: TTL square waveform with a 50% duty cycle. The SYNC output is at a logically high level when the ramp output is positive.

Output diagram

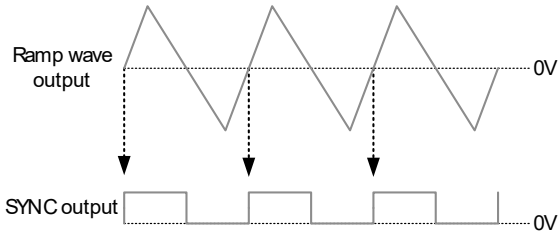

SYNC Output For ARB Wave Output diagram

SYNC output: A single TTL positive pulse at the start of each ARB period (pulse width = 1/sample rate).

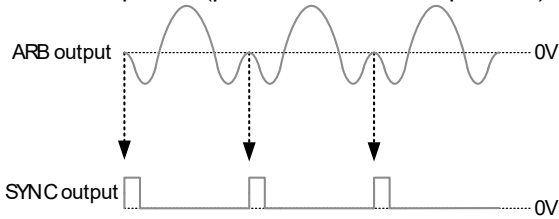

SYNC Output For AM

SYNC output: TTL square waveform with a 50% duty cycle. The SYNC output is at a logically high level when the modulated output is positive.

Output diagram

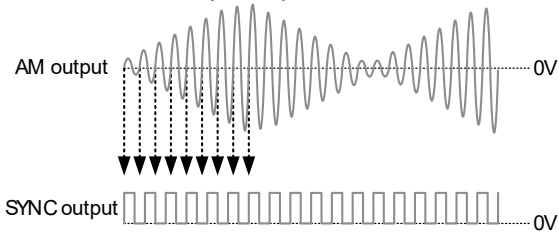

SYNC Output For FM

SYNC output: TTL square waveform with a 50% duty cycle. The SYNC output is at a logically high level when the modulated output is positive (The SYNC output is synchronized to the modulated output frequency).

Output diagram

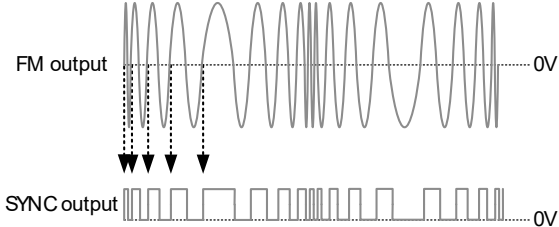

SYNC Output For FSK
 SYNC output: TTL square waveform with a 50% duty cycle. The SYNC output is at a logically high level when the modulated output is positive (The SYNC output is synchronized to the modulated output frequency).

Output diagram

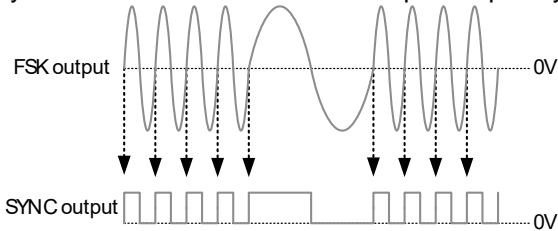

SYNC Output For Sweep
 SYNC output: TTL square waveform. The SYNC output is at a logically high level when the sweep output is positive (The SYNC output is synchronized to the sweep output frequency).

Output diagram

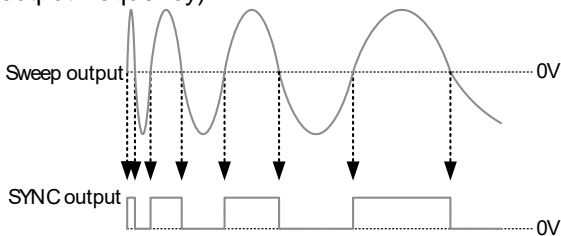

3-15. Save and Recall State/ARB Waveform

The FGX-2000 has non-volatile memory to store instrument state and ARB data. There are 10 memory locations numbered 0~19. Memory locations 0~9 saves/recalls the instrument state, memory locations 10~19 saves / recalls ARB data. The instrument saves the following states: the selected function (including ARB), frequency, amplitude, DC offset, duty cycle / symmetry, and any of the modulation parameters.

Panel Operation

1. Press the **Shift + Save/Recall** key to either select **Save** (to save the state) or **Recall** (to recall the state).

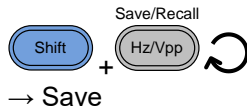

2. Save or Recall will be shown in the secondary display area.



3. Use the **scroll wheel** or **keypad** to choose the save/recall number.

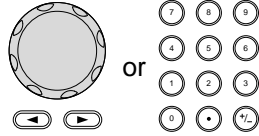

Use the **Enter** key to save/recall the state.



Note

The instrument state can be saved to any 10 (0~9) of the storage locations. ARB data can be saved to any 10 (10~19) instrument locations.

When a state is saved, it overwrites the previously saved state in the same location. If ARB data is recalled, the current state will be overwritten.

A memory location can only be recalled if it has been previously saved.

Example:
Save State



Example:
Recall State



4. REMOTE INTERFACE

4-1. Selecting the USB Remote Interface

The FGX-2000 uses a USB interface for remote control. Connecting to USB

USB configuration	PC side connector	Type A, host
	FGX side connector	Type B, slave
	Speed	1.1/2.0 (full speed)
	Class	CDC Class
	USB Driver	*.inf

Panel Operation

1. Connect the Type B USB - USB-A cable from the PC to the type B USB port on the rear panel. 
2. When the PC asks for the USB driver, select inf file included in the CD or download the driver from our website, www.texio.co.jp
If there is no request of the driver by the PC, please specify the inf file to update the device driver of FGX at the "Other devices" in the Device Manager of the PC.
3. The USB icon will appear when the USB connection is active.



4-1-1. Remote control terminal connection

Terminal application	Invoke the terminal application such as Hyper Terminal. Make note of the COM port, baud rate, stop bit, data bit, and parity accordingly from the Windows Device Manager. To check the COM port settings, see the Device Manager from Control Panel in the PC. For Windows.
Functionality check	Run this query command via the terminal. *idn? This should return the Manufacturer, Model number, Serial number, and Firmware version in the following format. TEXIO, FGX-2112, SN:XXXXXXXX, Vm.mm
 Note	^j and ^m can be used as the terminal character when using a terminal program.
PC Software	The proprietary PC software, downloadable from TEXIO website, can be used to download waveforms.

4-2. Command Syntax

- Compatible standard
- IEEE488.2, 1992 (fully compatible)
 - SCPI, 1994 (partially compatible)

Command Tree The SCPI standard is an ASCII based standard that defines the command syntax and structure for programmable instruments.

Commands are based on a hierarchical tree structure. Each command keyword is a node on the command tree with the first keyword as the root node. Each sub node is separated with a colon.

Shown below is a section of the SOURce[1] root node and the APPLy/OUTPut and SINusoid/SQUare sub nodes.

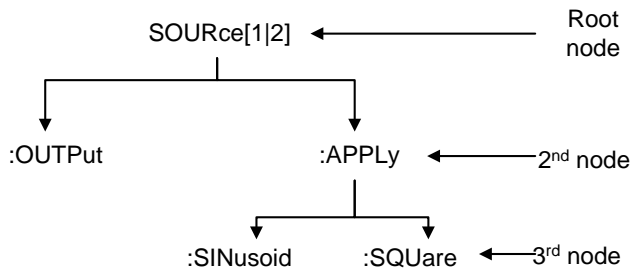

Command types	Commands can be separated into three distinct types, simple commands, compound commands and queries.
Simple	A single command with/without a parameter
Example	*OPC
Compound	Two or more commands separated by a colon (:) with/without a parameter
Example	SOURce:APPLy:SQUare
Query	A query is a simple or compound command followed by a question mark (?). A parameter (data) is returned. The maximum or minimum value for a parameter can also be queried where applicable.
Example	SOURce1:FREQUency? SOURce1:FREQUency? MIN

Command forms Commands and queries have two different forms, long and short. The command syntax is written with the short form of the command in capitals and the remainder (long form) in lower case.

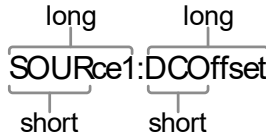

The commands can be written in capitals or lower-case, just so long as the short or long forms are complete. An incomplete command will not be recognized.

Below are examples of correctly written commands:

LONG: SOURCE1:DCOffset
 SOURCE1:DCOFFSET
 source1:dcoffset

SHORT: SOUR1:DCO
 sour1:dco

Command Format	<code>SOURCE1:DCOffset <offset>LF</code> 	1: command header 2: single space 3: parameter 4: message terminator
----------------	--	---

Square Brackets [] Commands that contain squares brackets indicate that the contents are optional. The function of the command is the same with or without the square bracketed items. Brackets are not sent with the command.

For example, the frequency query below can use any of the following 3 forms:

SOURCE1:FREQUENCY? [MINimum|MAXimum]
 SOURCE1:FREQUENCY? MAXimum
 SOURCE1:FREQUENCY? MINimum
 SOURCE1:FREQUENCY?

Braces { } Commands that contain braces indicate one item within the braces must be chosen. Braces are not sent with the command.

Angled Brackets < > Angle brackets are used to indicate that a value must be specified for the parameter. See the parameter description below for details. Angled brackets are not sent with the command.

Bars | Bars are used to separate multiple parameter choices in the command format.

Parameters	Type	Description	Example
	<Boolean>	Boolean logic	0, 1/ON,OFF

<NR1>	integers	0, 1, 2, 3
<NR2>	decimal numbers	0.1, 3.14, 8.5
<NR3>	floating point	4.5e-1, 8.25e+1
<NRf>	any of NR1, 2, 3	1, 1.5, 4.5e-1
<NRf+>	NRf type with a suffix including MINimum, MAXimum or DEFault parameters.	1, 1.5, 4.5e-1
<Numeric>	suffix including MINimum, MAXimum or DEFault parameters.	MAX, MIN, DEF
<aard>	Arbitrary ASCII characters.	
<discrete>	Discrete ASCII character parameters	IMM, EXT, MAN
<frequency> <peak deviation in Hz> <rate in Hz>	NRf+ type including frequency unit suffixes.	1 KHZ, 1.0 HZ, MHZ
<amplitude>	NRf+ type including voltage unit suffixes.	VPP, dBm, Vrms
<offset>	NRf+ type including voltage unit suffixes.	V
<seconds>	NRf+ type including time unit suffixes.	nS, uS, mS, S
<percent> <depth in percent>	NRf type	N/A
Message terminators	LF CR	line feed code (new line) and carriage return.
	LF	line feed code (new line)
	^j or ^m should be used when using a terminal program.	
Command Separators	Space	A space is used to separate a parameter from a keyword/command header.
	Colon (:)	A colon is used to separate keywords on each node.



Note

Semicolon (;)	A semicolon can be used to combine commands from different node levels. For example: SOURce1:PWM:SOURce? SOURce:PULSe:WIDTh? →SOURce1:PWM:SOURce?;SOURce: PULSe:WIDTh?
Comma (,)	When a command uses multiple parameters, a comma is used to separate the parameters. For example: SOURce:APPLy:SQUare 10KHZ,2.0 VPP,-1VDC

4-3. Command List

4-3-1. System Commands	57
4-3-2. Status Register Commands	57
4-3-2-1. *CLS	57
4-3-3. APPLy Commands.....	57
4-3-3-1. SOURce[1]:APPLy:SINusoid.....	59
4-3-3-2. SOURce[1]:APPLy:SQUare	59
4-3-3-3. SOURce[1]:APPLy:RAMP	59
4-3-3-4. SOURce[1]:APPLy:NOISe.....	60
4-3-3-5. SOURce[1]:APPLy:USER	60
4-3-3-6. SOURce[1]:APPLy?	61
4-3-4. Output Commands	61
4-3-4-1. SOURce[1]:FUNCTion	61
4-3-4-2. SOURce[1]:FREQUency.....	62
4-3-4-3. SOURce[1]:AMPLitude.....	63
4-3-4-4. SOURce[1]:DCOffset.....	64
4-3-4-5. SOURce[1]:SQUare:DCYCLE	64
4-3-4-6. SOURce[1]:RAMP:SYMMetry	65
4-3-4-7. OUTPut	66
4-3-4-8. SOURce[1]:OUTPut:LOAD.....	66
4-3-4-9. SOURce[1]:VOLTagE:UNIT	66
4-3-5. Amplitude Modulation (AM) Commands	67
4-3-5-1. SOURce[1]:AM:STATe.....	68
4-3-5-2. SOURce[1]:AM:SOURce.....	68
4-3-5-5. SOURce[1]:AM:DEPTH	69
4-3-6. Frequency Modulation (FM) Commands	70
4-3-6-1. SOURce[1]:FM:STATe.....	71
4-3-6-2. SOURce[1]:FM:SOURce	71
4-3-6-5. SOURce[1]:FM:DEViation	72
4-3-7. Frequency-Shift Keying (FSK) Commands.....	73
4-3-7-1. SOURce[1]:FSKey:STATe	74
4-3-7-2. SOURce[1]:FSKey:SOURce	74
4-3-7-3. SOURce[1]:FSKey:FREQUency	75
4-3-8. Frequency Sweep Commands	76
4-3-8-1. SOURce[1]:SWEep:STATe.....	76
4-3-8-2. SOURce[1]:FREQUency:START	77
4-3-8-3. SOURce[1]:FREQUency:STOP	77
4-3-8-4. SOURce[1]:SWEep:SPACing.....	78
4-3-8-5. SOURce[1]:SWEep:RATE	78
4-3-8-6. SOURce[1]:SWEep:SOURce.....	78
4-3-9. Frequency Counter Commands.....	79
4-3-9-1. COUNter:GATe.....	79
4-3-9-2. COUNter:STATe	79
4-3-9-3. COUNter:VALue?	80
4-3-10. Arbitrary Waveform Commands.....	80

4-3-10-1. SOURce[1]:FUNCTION USER.....	81
4-3-10-2. DATA:DAC.....	81
4-3-11. Save and Recall Commands	82
4-3-11-1. *SAV	82
4-3-11-2. *RCL.....	82

4-3-1. System Commands

4-3-1-1. *IDN?

→ Query

Description Returns the function generator manufacturer, model number, serial number and firmware version number in the following format:
 TEXTIO,FGX-2005,SN:XXXXXXXX,Vm.mm

Query Syntax **IDN?**

Return parameter <string>

Query Example ***IDN?**
 > TEXTIO,FGX-2005,SN:XXXXXXXX,Vm.mm
 Returns the identification of the function generator.

4-3-1-2. *RST

Set →

Description Reset the function generator to its factory default state.

 **Note** Note the *RST command will not delete instrument save states/ARB waveforms in memory.

Syntax ***RST**

4-3-2. Status Register Commands

4-3-2-1. *CLS

Set →

Description The *CLS command clears all the event registers, the error queue and cancels an *OPC command.

Syntax ***CLS**

4-3-3. APPLy Commands

The APPLy command has 5 different types of outputs (Sine, Square, Ramp, Noise, User(ARB)). The APPLy command is the quickest, easiest way to output waveforms remotely. Frequency, amplitude and offset can be specified for each function.

As only basic parameters can be set with the APPLy command, other parameters, such as duty and symmetry use the instrument default values. The APPLy command will set the trigger source to immediate and disable modulation and sweep modes, if active. The command also turns on the output command SOURce[1]:OUTP ON.

As the frequency, amplitude and offset parameters are in nested square

brackets, the amplitude can only be specified if the frequency has been specified and the offset can only be specified if the amplitude has been set. See the syntax below for the example:

SOURce1:APPLY:<function> [<frequency> [,<amplitude> [,<offset>]]]

Output Frequency For the output frequency, MINimum, MAXimum and DEFault can be used instead of specifying a frequency. The default frequency for all functions is set to 1 kHz.

The maximum and minimum frequency depends on the function used and the model of the frequency generator. If a frequency output that is out of range is specified, the max/min frequency will be used instead. A “-222” error will be generated from the remote terminal.

Function	Min frequency	Max frequency
Sine	0.1Hz	12MHz*
Square	0.1Hz	12MHz*
Ramp	0.1Hz	1MHz
Noise	Not applicable	Not applicable
User (ARB)	0.1Hz	12MHz

*The FGX-2005 is limited to 5MHz.

Output Amplitude When setting the amplitude, MINimum, MAXimum and DEFault can be used instead of specifying an amplitude. The range depends on the function being used. The default amplitude for all functions is 100 mVpp (into 50Ω).

Vrms, dBm or Vpp units can be used to specify the output units to use with the current command. Note, however, that the VOLT:UNIT command can be used to set the default units (Vrms, dBm, Vpp) for all commands. This will be applicable to the APPLY command when no unit is specified. The unit default is set to Vpp.

The output amplitude can be affected by the function and unit chosen. Vpp and Vrms or dBm values may have different maximum values due to differences such as crest factor. For example, a 5Vrms square wave will be adjusted to 3.536 Vrms for a sine wave.

DC Offset voltage The offset parameter can be set to MINimum, MAXimum or DEFault instead of a specified DC offset value. The default DC offset is 0 volts.

The maximum and minimum DC offset is limited by the

output amplitude as shown below.
 $|V_{offset}| < V_{max} - V_{pp}/2$

This means that the magnitude of the DC offset is determined by the output amplitude.
 If the specified DC offset is out of range, the maximum/minimum offset will be set instead. A “-222” error will be generated from the remote terminal.

4-3-3-1. SOURce[1]:APPLy:SINusoid (Set) →

Description	Outputs a sine wave when the command has executed. Frequency, amplitude and offset can also be set.	
Syntax	SOURce[1]:APPLy:SINusoid [<frequency> [,<amplitude> [,<offset>]]]	
Parameter	<frequency>	0.1Hz~12MHz*
	<amplitude>	1mV~10Vpp (50Ω)
	<offset>	-5V ~ +5V (50Ω)
	*FGX-2005 limited to 5MHz.	
Example	SOURce1:APPL:SIN MAX, 3.0, -2.5 Outputs a 3Vpp sine wave at 12MHz (max frequency) with a -2.5V offset.	

4-3-3-2. SOURce[1]:APPLy:SQUare (Set) →

Description	Outputs a square wave when the command has executed. Frequency, amplitude and offset can also be set. The duty cycle is fixed to 50%.	
Syntax	SOURce[1]:APPLy:SQUare [<frequency> [,<amplitude> [,<offset>]]]	
Parameter	<frequency>	0.1Hz ~ 12MHz*
	<amplitude>	1mV~10V (50Ω)
	<offset>	-5V ~ +5V (50Ω)
	*FGX-2005 limited to 5MHz.	
Example	SOURce1:APPL:SQU MAX, DEF, DEF Outputs a 100mVpp (DEF) square wave at 12MHz with 0 offset (DEF).	

4-3-3-3. SOURce[1]:APPLy:RAMP (Set) →

Description	Outputs a ramp wave when the command has executed. Frequency, amplitude and offset can also be set. The symmetry is fixed to 100%.	
-------------	--	--

Syntax	SOURce[1]:APPLY:RAMP [<frequency> [,<amplitude> [,<offset>]]]	
Parameter	<frequency> <amplitude> <offset>	0.1Hz~1MHz 1mV~10V (50Ω) -5V ~ +5V (50Ω)
Example	SOUR1:APPL:RAMP 2KHZ,MAX,MAX Sets the frequency to 2kHz and sets the amplitude and offset to the maximum.	

4-3-3-4. SOURce[1]:APPLY:NOISe (Set) →

Description	Outputs Gaussian noise with a 20 MHz bandwidth. Amplitude and offset can also be set.	
 Note	The Frequency parameter is not used with the noise function; however a value (or DEFault) <i>must still</i> be specified. The frequency is remembered for the next function used.	
Syntax	SOURce[1]:APPLY:NOISe [<frequency> DEFault> [,<amplitude> [,<offset>]]]	
Parameter	<frequency> <amplitude> <offset>	0.1Hz~12MHz* 1mV~10V (50Ω) -5V ~ +5V (50Ω) *FGX-2005 limited to 5MHz.
Example	SOURce1:APPL:NOIS DEF, 5.0, 2.0 Sets the amplitude to 5 volts with an offset of 2 volts.	

4-3-3-5. SOURce[1]:APPLY:USER (Set) →

Description	Outputs an arbitrary waveform that is specified from the FUNC:USER command.	
 Note	Frequency and amplitude values are not used with this function; however a value (or DEFault) must be specified. The values are remembered for the next function used.	
Syntax	SOURce[1]:APPLY:USER [<frequency> [,<amplitude> [,<offset>]]]	
Parameter	<frequency> <amplitude> <offset>	0.1Hz~10MHz 1mV~10V (50Ω) -5V ~ +5V (50Ω)
Example	SOUR1:APPL:USER Outputs the ARB waveform specified in the FUNC:USER command.	

4-3-3-6. SOURce[1]:APPLy? → Query

Description	Outputs a string with the current settings.
 Note	The returned string can be passed back, when appended to the APPLy Command. This is intended to be used to return the function generator to a known state. I.e., SOURce[1]:APPL:<passed back string>
Query Syntax	SOURce[1]:APPLy?
Return Parameter	<string> Function(<NRf>), frequency(<NRf>), amplitude(<NRf>),offset(<NRf>)
Query Example	SOUR1:APPL? >"SIN +5.000000000000E+03,+3.0000E+00,-2.50E+00" Returns a string with the current function and parameters, Sine, 5kHz, 3Vpp, -2.5V offset.

4-3-4. Output Commands

Unlike the APPLy commands, the Output commands are low level commands to program the function generator.

This section describes the low-level commands used to program the function generator. Even though the APPLy command is the easiest way to program the function generator, it lacks the ability to change individual parameters.

The Output commands on the other hand can be used to set individual parameters, or those parameters that cannot be programmed with the APPLy command.

4-3-4-1. SOURce[1]:FUNcTION Set → → Query

Description	The FUNcTION command selects and outputs the selected output function. The User parameter outputs an arbitrary waveform previously set by the SOURce[1]:FUNC:USER command. The previously set frequency, amplitude and offset values are used automatically.
 Note	If the function mode is changed and the current frequency setting is not supported by the new mode, the frequency setting will be altered to the next highest value. Vpp and Vrms or dBm amplitude values may have different maximum values due to differences such as crest factor. For example, if a 5Vrms square wave is changed to a sinewave, then the Vrms value is automatically adjusted to 3.536Vrms.

The modulation and sweep modes can only be used with some of the basic waveforms. If a mode is not supported, the conflicting mode will be disabled. See the table below.

	Sine	Square	Ramp	Noise	ARB
AM	✓	✓	✓	×	×
FM	✓	✓	✓	×	×
FSK	✓	✓	✓	×	×
SWEEP	✓	✓	✓	×	×

Syntax	SOURce[1]:FUNCTION {SINusoid SQUare RAMP NOISE USER}	
Example	SOUR1:FUNC SIN Sets the output as a sine function.	
Query Syntax	SOURce[1]:FUNCTION?	
Return Parameter	SIN, SQU, RAMP, NOIS, USER	Returns the current output type.
Query Example	SOUR1:FUNC? >SIN Current output is sine.	

4-3-4-2. SOURce[1]:FREQUENCY

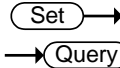

Description Sets the output frequency for the SOURce[1]:FUNCTION command. The query command returns the current frequency setting.



The maximum and minimum frequency depends on the function mode.

Sine, Square	0.1Hz~12MHz*
Ramp	0.1Hz ~ 1MHz
Noise	Not applicable
User	0.1Hz~12MHz*

*FGX-2005 limited to 5MHz.

If the function mode is changed and the current frequency setting is not supported by the new mode, the frequency setting will be altered to the next highest value.

The duty cycle of square waveforms depends on the frequency settings:

- 1% to 99% (*frequency* < 100KHz)
- 20% to 80% (100KHz < *frequency* < 5 MHz)
- 40% to 60% (5 MHz < *frequency* < 10 MHz)
- 50% (*frequency* > 10 MHz)

If the frequency is changed and the set duty cycle cannot support the new frequency, the highest duty cycle available at that frequency will be used. A “-221” error will be generated from the remote terminal.

Syntax	SOURce[1]:FREQuency {<frequency> MINimum MAXimum}
Example	SOUR1:FREQ MAX Sets the frequency to the maximum for the current mode.
Query Syntax	SOURce[1]:FREQuency?
Return Parameter	<NR3> Returns the frequency for the current mode.
Query Example	SOUR1:FREQ? MAX >+1.000000000000E+03 The maximum frequency that can be set for the current function is 1MHz.

4-3-4-3. SOURce[1]:AMPLitude

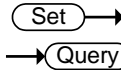

Description Sets the output amplitude for the SOURce[1]:FUNCTION command. The query command returns the current amplitude settings.



Note

The maximum and minimum amplitude depends on the output termination. The default amplitude for all functions is 100 mVpp (50Ω).

The offset and amplitude are related by the following equation.

$$|V_{offset}| < V_{max} - V_{pp}/2$$

The output amplitude can be affected by the function and unit chosen. Vpp and Vrms or dBm values may have different maximum values due to differences such as crest factor. For example, a 5Vrms square wave will be adjusted to 3.536 Vrms for a sine wave.

The amplitude units can be explicitly used each time the SOURce[1]:AMPLitude command is used. Alternatively, the VOLT:UNIT command can be used to set the amplitude units for *all* commands.

Syntax	SOURce[1]:AMPLitude {< amplitude> MINimum MAXimum}
Example	SOUR1:AMPL MAX Sets the amplitude to the maximum for the current mode.
Query Syntax	SOURce[1]:AMPLitude? {MINimum MAXimum}
Return Parameter	<NR3> Returns the amplitude for the current mode.

Query Example **SOUR1:AMPL? MAX**
>+5.0000E+00

The maximum amplitude that can be set for the current function is 5 volts.

4-3-4-4. SOURce[1]:DCOffset

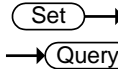

Description	Sets or queries the DC offset for the current mode.
Note	The offset parameter can be set to MINimum or MAXimum. The default offset is 0 volts. The offset is limited by the output amplitude as shown below. $ V_{offset} < V_{max} - V_{pp}/2$ If the output specified is out of range, the maximum offset will be set. The maximum offset is $\pm 5V$ into 50Ω .
Syntax	SOURce[1]:DCOffset {< offset> MINimum MAXimum}
Example	SOUR1:DCO MAX Sets the offset to the maximum for the current mode.
Query Syntax	SOURce[1]:DCOffset? {MINimum MAXimum}
Return Parameter	<NR3> Returns the offset for the current mode.
Query Example	SOUR1:DCO? >+3.0000E+00 The offset for the current mode is set to +3 volts.

4-3-4-5. SOURce[1]:SQUare:DCYCLE

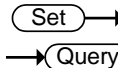

Description	Sets or queries the duty cycle for square waves only. The setting is remembered if the function mode is changed. The default duty cycle is 50%.
Note	The duty cycle of square waveforms depend on the frequency settings. 1% to 99% (<i>frequency</i> < 100KHz) 20% to 80% (100KHz < <i>frequency</i> < 5 MHz) 40% to 60% (5 MHz < <i>frequency</i> < 10 MHz) 50% (<i>frequency</i> > 10 MHz) If the frequency is changed and the set duty cycle cannot support the new frequency, the highest duty cycle available at that frequency will be used. A “-221” error will be generated from the remote terminal.

	For square waveforms, the APPLy command and AM/FM modulation modes ignore the duty cycle settings.
Syntax	SOURce[1]:SQUare:DCYCl e {< percent> MINimum MAXimum}
Example	SOUR1:SQU:DCYC MAX Sets the duty cycle to the highest possible for the current frequency.
Query Syntax	SOURce[1]:SQUare:DCYCl e? {MINimum MAXimum}
Return Parameter	<NR3> Returns the duty cycle as a percentage.
Query Example	SOUR1:SQU:DCYC? >+5.00E+01 The duty cycle is set 50%.

4-3-4-6. SOURce[1]:RAMP:SYMMetry

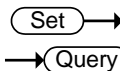

Description	Sets or queries the symmetry for ramp waves only. The setting is remembered if the function mode is changed. The default symmetry is 100%. 0% symmetry is a ramp waveform with a negative going transition. 100% symmetry is a ramp waveform with a positive going transition.
-------------	---

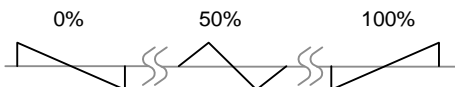

 Note	For ramp waveforms, the Apply command and AM/FM modulation modes ignore the current symmetry settings.
Syntax	SOURce[1]:RAMP:SYMMetry {< percent> MINimum MAXimum}
Example	SOUR[1]:RAMP:SYMM MAX Sets the symmetry to the 100%.
Query Syntax	SOURce[1]:RAMP:SYMMetry? {MINimum MAXimum}
Return Parameter	<NR3> Returns the symmetry as a percentage.
Query Example	SOUR1:RAMP:SYMMetry? >+1.0000E+02 The symmetry is set as 100%.

4-3-4-7. OUTPUT

Set →

→ Query

Description Enables/Disables or queries the front panel output. The default is set to off.

Syntax **OUTPUT {OFF|ON}**

Example **OUTP ON**
Turns the output on.

Query Syntax **OUTPUT?**

Return 1 ON

Parameter 0 OFF

Query Example **OUTP?**
>1
The output is currently on.

4-3-4-8. SOURce[1]:OUTPUT:LOAD

Set →

→ Query

Description Sets or queries the output termination. Two impedance settings can be chosen, DEFault (50Ω) and INFinity (high impedance).

Syntax **SOURce[1]:OUTPUT:LOAD{DEF|INF}**

Example **SOUR:OUTP:LOAD DEF**
Sets the channel 1 output termination to 50Ω.

Query Syntax **SOURce[1]:OUTPUT:LOAD?**

Return Parameter DEF Default

INF INFINITY

Example **SOUR:OUTP:LOAD?**
>DEF
The output termination for channel 1 is set to 50Ω.

4-3-4-9. SOURce[1]:VOLTage:UNIT

Set →

→ Query

Description Sets or queries the output amplitude units. There are three types of units: VPP, VRMS and DBM. The SOURce[1]:VOLTage:UNIT command does not set the offset units.



Note

The units set with the VOLTage:UNIT command will be used as the default unit for all amplitude units unless a different

	unit is specifically used for a command, such as those used with the APPLY commands.
Syntax	SOURCE[1]:VOLTage:UNIT {VPP VRMS DBM}
Example	SOUR1:VOLT:UNIT VPP Sets the amplitude units to Vpp.
Query Syntax	SOURCE[1]:VOLTage:UNIT?
Return	VPP Vpp
Parameter	VRMS Vrms
	DBM dBm
Query Example	SOUR1:VOLT:UNIT? >VPP The amplitude units are set to Vpp.

4-3-5. Amplitude Modulation (AM) Commands

To successfully create an AM waveform, the following commands must be executed in order.

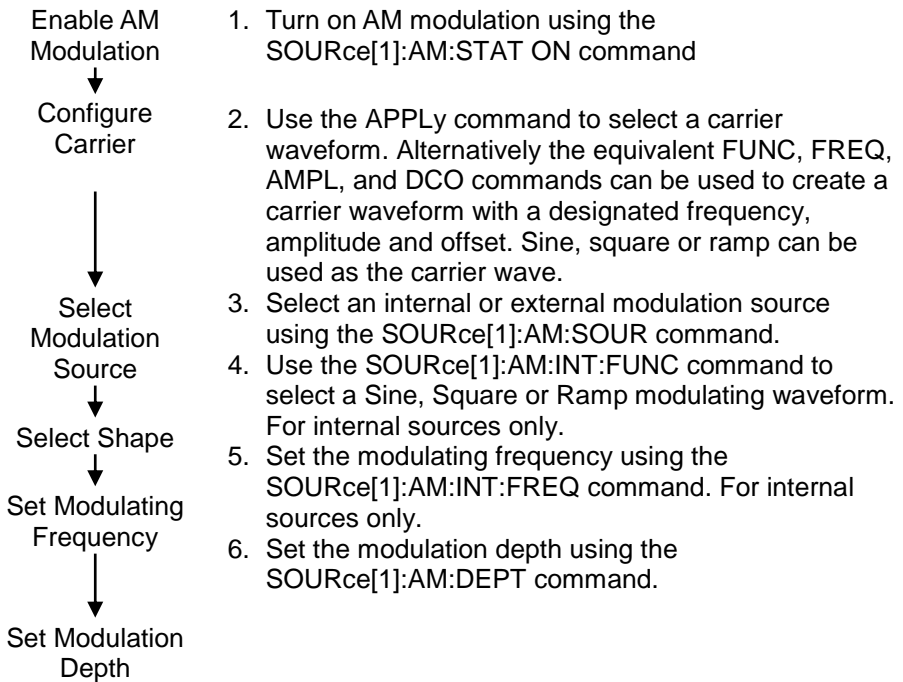

4-3-5-1. SOURce[1]:AM:STATe

Set →

→ Query

Description Sets or disables AM modulation. By default AM modulation is disabled. AM modulation must be enabled before setting other parameters.



Note

As only one mode is allowed at any one time, other modulation modes (inc. Sweep/FSK) will be disabled when AM modulation is enabled.

Syntax **SOURce[1]:AM:STATe {OFF|ON}**

Example **SOUR1:AM:STAT ON**

Enables AM modulation.

Query Syntax **SOURce[1]:AM:STATe?**

Return 0 Disabled (OFF)

Parameter 1 Enabled (ON)

Query Example **SOUR1:AM:STAT?**

>1

AM modulation mode is currently enabled.

4-3-5-2. SOURce[1]:AM:SOURce

Set →

→ Query

Description Sets or queries the modulation source as internal or external. Internal is the default modulation source.



Note

If an external modulation source is selected, modulation depth is limited to $\pm 5V$ from the MOD input port on the rear panel. For example, if modulation depth is set to 100%, then the maximum amplitude is +5V, and the minimum amplitude is -5V.

Syntax **SOURce[1]:AM:SOURce {INTERNAL|EXTERNAL}**

Example **SOUR1:AM:SOUR EXT**

Sets the modulation source to external.

Query Syntax **SOURce[1]:AM:SOURce?**

Return INT Internal

Parameter EXT External

Query Example **SOUR1:AM:SOUR?**

>INT

The modulation source is set to internal.

4-3-5-3. SOURce[1]:AM:INTernal:FUNCtion

Set →

→ Query

Description Sets the shape of the modulating waveform from sine, square or ramp. The default shape is sine.



Note

Square waveforms have a 50% duty cycle. Ramp waveforms have a symmetry of 100%.

Syntax **SOURce[1]:AM:INTernal:FUNCtion {SINusoid|SQUare|RAMP }**

Example **SOUR1:AM:INT:FUNC SIN**

Sets the AM modulating wave shape to sine.

Query Syntax **SOURce[1]:AM:INTernal:FUNCtion?**

Return SIN Sine

Parameter SQU Square

RAMP Ramp

Query Example **SOUR1:AM:INT:FUNC?**
>SIN

The shape for the modulating waveform is Sine.

4-3-5-4. SOURce[1]:AM:INTernal:FREQuency

Set →

→ Query

Description Sets the frequency of the internal modulating waveform only. The default frequency is 100Hz.

Syntax **SOURce[1]:AM:INTernal:FREQuency {<frequency>|MINimum|MAXimum}**

Parameter <frequency> 2 mHz~ 20 kHz

Example **SOUR1:AM:INT:FREQ +1.0000E+02**

Sets the modulating frequency to 100Hz.

Query Syntax **SOURce[1]:AM:INTernal:FREQuency?**
[MINimum|MAXimum]

Return <NR3> Returns the frequency in Hz.

Parameter

Query Example **SOUR1:AM:INT:FREQ? MIN**
>+1.0000E+02

Returns the minimum frequency allowed.

4-3-5-5. SOURce[1]:AM:DEPTTh

Set →

→ Query

Description Sets or queries the modulation depth for internal sources only. The default is 100%.



Note

The function generator will not output more than $\pm 5V$, regardless of the modulation depth. The modulation depth of an external source is controlled using the $\pm 5V$ MOD input port on the rear panel, and not the `SOURce[1]:AM:DEPTH` command.

Syntax	SOURce[1]:AM:DEPTH {<depth in percent> [MINimum]MAXimum}	
Parameter	<depth in percent>	0~120%
Example	SOUR1:AM:DEPT 50 Sets the modulation depth to 50%.	
Query Syntax	SOURce[1]:AM:DEPT? [MINimum]MAXimum]	
Return Parameter	<NR3>	Return the modulation depth as a percentage.
Query Example	SOUR1:AM:DEPT? >+1.0000E+02 The modulation depth is 100%.	

4-3-6. Frequency Modulation (FM) Commands

The following is an overview of the steps required to generate an FM waveform.

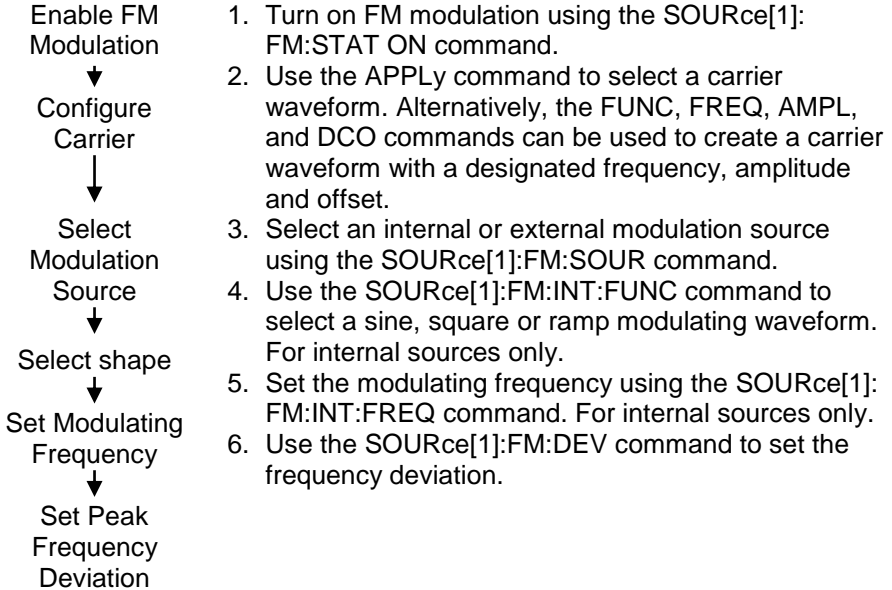

4-3-6-1. SOURce[1]:FM:STATe

Set →

→ Query

Description Sets or disables FM modulation. By default FM modulation is disabled. FM modulation must be enabled before setting other parameters.



Note

As only one mode is allowed at any one time, other modes (AM, FSK, Sweep etc.) will be disabled when FM modulation is enabled.

Syntax **SOUR[1]:FM:STATe {OFF|ON}**

Example **SOUR1:FM:STAT ON**

Enables FM modulation.

Query Syntax **SOURce[1]:FM:STATe?**

Return 0 Disabled (OFF)

Parameter 1 Enabled (ON)

Query Example **SOUR1:FM:STAT?**

>1

FM modulation mode is currently enabled.

4-3-6-2. SOURce[1]:FM:SOURce

Set →

→ Query

Description Sets or queries the modulation source as internal or external. Internal is the default modulation source.



Note

If an external modulation source is selected, the frequency deviation is limited to $\pm 5V$ from the MOD input port on the rear panel. For example, if frequency deviation is set to 100Hz, then +5V will increase the frequency by 100Hz.

Syntax **SOURce[1]:FM:SOURce {INTERNAL|EXTERNAL}**

Example **SOUR1:FM:SOUR EXT**

Sets the modulation source to external.

Query Syntax **SOURce[1]:FM:SOURce?**

Return INT Internal

Parameter EXT External

Query Example **SOUR1:FM:SOUR?**

>INT

The modulation source is set to internal.

4-3-6-3. SOURce[1]:FM:INTernal:FUNCtion

Set →

→ Query

Description Sets the shape of the modulating waveform from sine, square or ramp. The default shape is sine.



Note

Square waveforms have a 50% duty cycle. Ramp waveforms have a symmetry of 100%.

Syntax	SOURce[1]:FM:INTernal:FUNCTION {SINusoid SQUare RAMP }	
Example	SOUR1:FM:INT:FUNC SIN Sets the FM modulating wave shape to sine.	
Query Syntax	SOURce[1]:FM:INTernal:FUNCTION?	
Return	SIN	Sine
Parameter	SQU	Square
	RAMP	Ramp
Query Example	SOUR1:FM:INT:FUNC? >SIN The shape for the modulating waveform is Sine.	

4-3-6-4. SOURce[1]:FM:INTernal:FREQuency (Set) →
→ (Query)

Description	Sets the frequency of the internal modulating waveform only. The default frequency is 10Hz.	
Syntax	SOURce[1]:FM:INTernal:FREQuency {<frequency> MINimum MAXimum}	
Parameter	<frequency> 2 mHz ~ 20 kHz	
Example	SOUR1:FM:INT:FREQ +1.0000E+02 Sets the modulating frequency to 100Hz.	
Query Syntax	SOURce[1]:FM:INTernal:FREQuency? [MINimum MAXimum]	
Return	<NR3>	Returns the frequency in Hz.
Parameter		
Query Example	SOUR1:FM:INT:FREQ? MAX >+2.0000E+04 Returns the maximum frequency allowed.	

4-3-6-5. SOURce[1]:FM:DEVIation (Set) →
→ (Query)

Description	Sets or queries the peak frequency deviation of the modulating waveform from the carrier waveform. The default peak deviation is 100Hz. The frequency deviation of external sources is controlled using the ±5V MOD INPUT terminal on the rear panel. A positive signal (>0~+5V) will increase the deviation (up to the set frequency deviation), whilst a negative voltage will reduce the deviation.	
-------------	---	--



Note

The relationship of peak deviation to modulating frequency and carrier frequency is shown below.

Peak deviation = modulating frequency – carrier frequency.

The carrier frequency must be greater than or equal to the peak deviation frequency. The sum of the deviation and carrier frequency must not exceed the maximum frequency for a specific carrier shape + 1kHz. If an out of range deviation is set for any of the above conditions, the deviation will be automatically adjusted to the maximum value allowed and an “out of range” error will be generated. For square wave carrier waveforms, the deviation may cause the duty cycle frequency boundary to be exceeded. In these conditions the duty cycle will be adjusted to the maximum allowed and a “-221” error will be generated.

Syntax	SOURce[1]:FM:DEVIation {<peak deviation in Hz> MINimum MAXimum}	
Parameter	<peak deviation in Hz>	DC ~ 12MHz DC~1MHz (Ramp)

Example	SOUR1:FM:DEV MAX Sets the frequency deviation to the maximum value allowed.	
---------	---	--

Query Syntax	SOURce[1]:FM:DEVIation? [MINimum MAXimum]	
Return Parameter	<NR3>	Returns the frequency deviation in Hz.

Query Example	SOURce1:FM:DEVIation? MAX >+1.0000E+06 The maximum frequency deviation for the current function is 1MHz.	
---------------	---	--

4-3-7. Frequency-Shift Keying (FSK) Commands

The following is an overview of the steps required to generate an FSK modulated waveform.

- | | |
|---|--|
| Enable FSK Modulation
↓
Configure Carrier
↓
Select FSK Source | <ol style="list-style-type: none"> 1. Turn on FSK modulation using the SOURce[1]: FSK:STAT ON command. 2. Use the APPLy command to select a carrier waveform. Alternatively, the FUNC, FREQ, AMPL, and DCO commands can be used to create a carrier waveform with a designated frequency, amplitude and offset. The carrier waveform can be sine, square or ramp. 3. Select an internal or external modulation source using the SOURce[1]:FSK:SOUR command. |
|---|--|

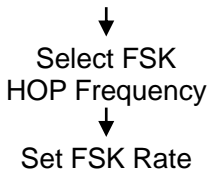

4. Set the hop frequency using the `SOURce[1]:FSK:FREQ` command.
5. Use the `SOURce[1]:FSK:INT:RATE` command to set the FSK rate. The FSK rate can only be set for internal sources.

4-3-7-1. `SOURce[1]:FSKey:STATe`

(Set) →

→ (Query)

Description	Turns FSK Modulation on or off. By default FSK modulation is off.	
 Note	As only one mode is allowed at any one time, other modes (AM, FM, Sweep etc.) will be disabled when FSK modulation is enabled.	
Syntax	<code>SOURce[1]:FSKey:STATe {OFF ON}</code>	
Example	<code>SOUR1:FSK:STAT ON</code> Enables FSK modulation.	
Query Syntax	<code>SOURce[1]:FSKey:STATe?</code>	
Return	0	Disabled (OFF)
Parameter	1	Enabled (ON)
Query Example	<code>SOUR1:FSK:STAT?</code> <code>>1</code> FSK modulation is currently enabled.	

4-3-7-2. `SOURce[1]:FSKey:SOURce`

(Set) →

→ (Query)

Description	Sets or queries the FSK source as internal or external. Internal is the default source.	
 Note	If an external FSK source is selected, FSK rate is controlled by the Trigger input port on the rear panel.	
Syntax	<code>SOURce[1]:FSKey:SOURce {INTernal EXTernal}</code>	
Example	<code>SOUR1:FSK:SOUR EXT</code> Sets the FSK source to external.	
Query Syntax	<code>SOURce[1]:FSKey:SOURce?</code>	
Return	INT	Internal
Parameter	EXT	External
Query Example	<code>SOUR1:FSK:SOUR?</code> <code>>INT</code> The FSK source is set to internal.	

4-3-7-3. SOURce[1]:FSKey:FREQUENCY

Set →

→ Query

Description	Sets the FSK hop frequency. The default hop frequency is set to 100Hz.
 Note	For FSK, the modulating waveform is a square wave with a duty cycle of 50%.
Syntax	SOURce[1]:FSKey:FREQUENCY {<frequency> MINimum MAXimum}
Parameter	<frequency> 0.1Hz~ 12MHz* 0.1Hz~ 1MHz (Ramp) * FGX-2005 limited to 5MHz.
Example	SOUR1:FSK:FREQ +1.0000E+02 Sets the FSK hop frequency to 100Hz.
Query Syntax	SOURce[1]:FSKey:FREQUENCY? [MINimum MAXimum]
Return	<NR3> Returns the frequency in Hz.
Parameter	
Query Example	SOUR1:FSK:FREQ? MAX >+2.0000E+07 Returns the maximum hop frequency allowed.

4-3-7-4. SOURce[1]:FSKey:INTernal:RATE

Set →

→ Query

Description	Sets or queries the FSK rate for internal sources only. External sources will ignore this command.
 Note	
Syntax	SOURce[1]:FSKey:INTernal:RATE {<rate in Hz> MINimum MAXimum}
Parameter	<rate in Hz> 2 mHz~100 kHz
Example	SOUR1:FSK:INT:RATE MAX Sets the rate to the maximum (100kHz).
Query Syntax	SOURce[1]:FSKey:INTernal:RATE? [MINimum MAXimum]
Return	<NR3> Returns the FSK rate in Hz.
Parameter	
Query example	SOUR1:FSK:INT:RATE? >+1.0000E+05 Returns the FSK rate (100kHz).

4-3-8. Frequency Sweep Commands

Below shows the order in which commands must be executed to perform a sweep.

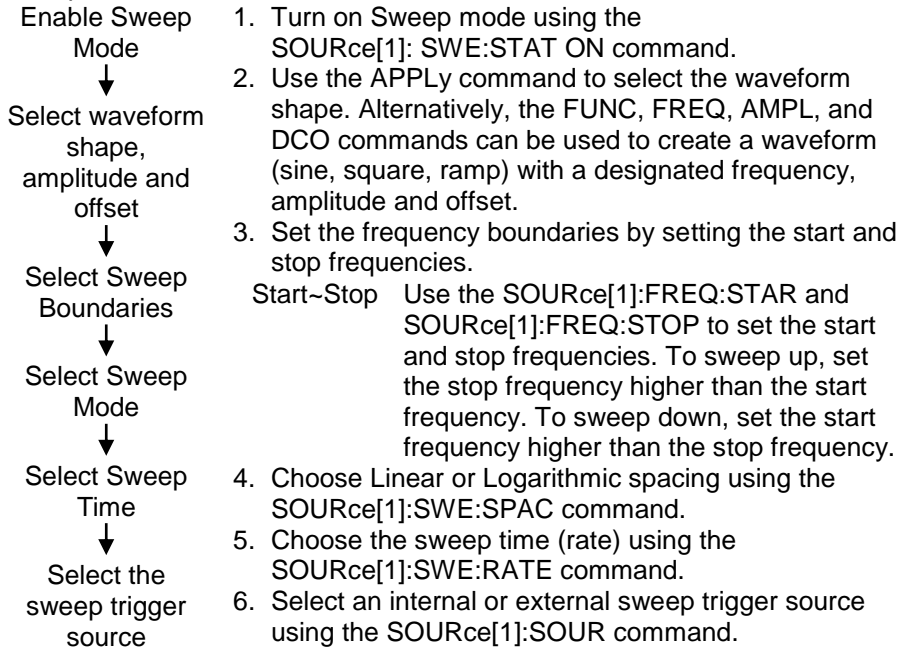

4-3-8-1. SOURce[1]:SWEep:STATe

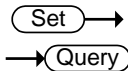

Description	Sets or disables Sweep mode. By default sweep is disabled. Sweep must be enabled before setting other parameters.
-------------	---

Note	Any modes will be disabled if sweep mode is enabled.
------	--

Syntax	SOURce[1]:SWEep:STATe {OFF ON}
--------	---------------------------------------

Example	SOUR1:SWE:STAT ON Enables sweep mode.
---------	---

Query Syntax	SOURce[1]:SWEep:STATe?
--------------	-------------------------------

Return	0 Disabled (OFF)
--------	---------------------------------------

Parameter	1 Enabled (ON)
-----------	-------------------------------------

Query Example	SOUR1:SWE:STAT? >1 Sweep mode is currently enabled.
---------------	--

4-3-8-2. SOURce[1]:FREQuency:STARt

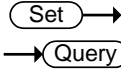

Description	Sets the start frequency of the sweep. 100Hz is the default start frequency.	
Note	To sweep up set the stop frequency higher than the start frequency. Set the stop frequency lower than the start frequency to sweep down.	
Syntax	SOURce[1]:FREQuency:STARt {<frequency> MINimum MAXimum}	
Parameter	<frequency> 0.1Hz ~ 12MHz 0.1Hz ~ 1MHz (Ramp)	
Example	SOUR1:FREQ:STAR +2.0000E+03 Sets the start frequency to 2kHz.	
Query Syntax	SOURce[1]:FREQuency:STARt? [MINimum] MAXimum]	
Return Parameter	<NR3>	Returns the start frequency in Hz.
Query Example	SOUR1:FREQ:STAR? MAX >+2.0000E+07 Returns the maximum start frequency allowed.	

4-3-8-3. SOURce[1]:FREQuency:STOP

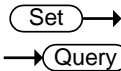

Description	Sets the stop frequency of the sweep. 1 kHz is the default start frequency.	
Note	To sweep up set the stop frequency higher than the start frequency. Set the stop frequency lower than the start frequency to sweep down.	
Syntax	SOURce[1]:FREQuency:STOP {<frequency> MINimum MAXimum}	
Parameter	<frequency> 0.1Hz ~ 12MHz 0.1Hz ~ 1MHz (Ramp)	
Query Example	SOUR1:FREQ:STOP +2.0000E+03 Sets the stop frequency to 2kHz.	
Query Syntax	SOURce[1]:FREQuency:STOP? [MINimum] MAXimum]	
Return Parameter	<NR3>	Returns the stop frequency in Hz.
Example	SOUR1:FREQ:STOP? MAX >+2.0000E+07 Returns the maximum stop frequency allowed.	

4-3-8-4. SOURce[1]:SWEep:SPACing

Set →

→ Query

Description	Sets linear or logarithmic sweep spacing. The default spacing is linear.	
Syntax	SOURce[1]:SWEep:SPACing {LINear LOGarithmic}	
Example	SOUR1:SWE:SPAC LIN Sets the spacing to linear.	
Query Syntax	SOURce[1]:SWEep:SPACing?	
Return	LIN	Linear spacing
Parameter	LOG	Logarithmic spacing
Query Example	SOUR1:SWE:SPAC? >LIN The spacing is currently set as linear.	

4-3-8-5. SOURce[1]:SWEep:RATE

Set →

→ Query

Description	Sets or queries the sweep rate. The default sweep rate is 100 Hz. This command is the equivalent to using the Rate function on the front panel.	
 Note	The function generator automatically determines the number of frequency points that are used for the sweep based on the sweep rate.	
Syntax	SOURce[1]:SWEep:RATE {<Hz> MINimum MAXimum}	
Parameter	<Hz>	2mHz ~1kHz (equivalent to a sweep time of 500s ~ 1ms)
Example	SOUR1:SWE:RATE +1.0000E+00 Sets the rate to 1 Hz (1 second).	
Query Syntax	SOURce[1]:SWEep:RATE? {<Hz> MINimum MAXimum}	
Return	<NR3>	Returns sweep rate in Hz.
Parameter		
Query Example	SOUR1:SWE:RATE? >+2.000000E+01 Returns the sweep rate (20 Hz).	

4-3-8-6. SOURce[1]:SWEep:SOURce

Set →

→ Query

Description	Sets or queries the trigger source as immediate (internal) or external. Immediate (internal) is the default trigger source. IMMEDIATE will constantly output a swept waveform. EXTERNAL will output a swept waveform after each external trigger pulse (TTL positive edge).	
-------------	---	--

 Note	If EXTERNAL is selected, the trigger period must be greater than the sweep time + 125nS.
Syntax	SOURCE[1]: SWEEP:SOURCE {IMMEDIATE EXTERNAL }
Example	SOUR1: SWE:SOUR EXT Sets the sweep source to external.
Query Syntax	SOURCE[1]: SWEEP:SOURCE?
Return	IMM Immediate
Parameter	EXT External
Query Example	SOUR1:SWE:SOUR? >IMM The sweep source is set to immediate.

4-3-9. Frequency Counter Commands

4-3-9-1. COUNTER:GATE

Set →

→ Query

Description Sets or queries the gate time for the frequency counter function.

 Note	The counter function is only applicable for the FGX-21XX models.
Syntax	COUNTER:GATE <seconds>
Parameter	<seconds> 0.01S, 0.1S, 1S, 10S
Example	COUN:GAT 10S Sets the gate time to 10 seconds.
Query Syntax	COUNTER:GATE?
Return	<NR3> Returns the gate time in seconds.
Parameter	
Query Example	COUN:GAT? >1.000E-02 The gate time is current set to 0.01 second.

4-3-9-2. COUNTER:STATE

Set →

→ Query

Description Turns the frequency counter on/off.

Syntax	COUNTER:STATE [ON/OFF]
 Note	The counter function is only applicable for the FGX2115.
Parameter	ON Turns the counter function on. OFF Turns the counter function off.
Example	COUN:STAT ON Turns the frequency counter on.
Query Syntax	COUNTER:STATE?

Return	0	Counter function is off.
Parameter	1	Counter function is on.
Query Example	COUN:STAT? >1 Counter is on.	

4-3-9-3. COUNter:VALue?

→ Query

Description	Queries the counter frequency.	
 Note	The counter function is only applicable for the FGX-21XX models.	
Syntax	COUNter:VALue?	
Return	<NR3>	Returns the counter frequency.
Parameter		
Example	COUN:VAL? >1.000E+03 The counter frequency is 1kHz.	

4-3-10. Arbitrary Waveform Commands

Use the steps below to output an arbitrary waveform over the remote interface.

- | | |
|--|---|
| <p>Output Arbitrary Waveform</p> <p>↓</p> <p>Select Waveform Freq, ampl ,offset</p> <p>↓</p> <p>Load Waveform Data</p> <p>↓</p> <p>Set Waveform Rate</p> | <ol style="list-style-type: none"> 1. Use the SOURce[1]:FUNCTION USER command to output the arbitrary waveform currently selected in memory. 2. Use the APPLy command to select frequency, amplitude and DC offset. Alternatively, the FUNC, FREQ, AMPL, and DCO commands can be used. 3. Waveform data (4k points per waveform) can be downloaded into volatile memory using the DATA:DAC command. Binary integer or decimal integer values in the range of ± 511 can be used. 4. The waveform rate is the product of the number of points in the waveform and the waveform frequency.
Rate = Frequency × # points |
|--|---|

Range:	Rate:	0.1Hz ~ 20MHz
	Frequency:	0.1Hz ~ 10MHz
	# points:	2~4096

4-3-10-1. SOURce[1]:FUNCtion USER

Set →

→ Query

Description Use the SOURce[1]:FUNCtion USER command to output the arbitrary waveform currently selected in memory. The waveform is output with the current frequency, amplitude and offset settings. The query returns the current output.

Syntax **SOURce[1]:FUNCtion USER**

Example **SOUR1:FUNC USER**
Selects and outputs the current waveform in memory.

Query Syntax **SOURce[1]:FUNCtion?**

Return	SIN	Sine wave
Parameter	SQU	Square wave
	RAMP	Ramp wave
	NOIS	Noise wave
	ARB	Arbitrary wave

Query Example **SOURce1:FUNCtion?**
>SQU
A square waveform is the current output.

4-3-10-2. DATA:DAC

Set →

Description The DATA:DAC command is used to download binary or decimal integer values into memory using the IEEE-488.2 binary block format or as an ordered list of values. After the values have been downloaded into memory the SOURce[1]:FUNCtion USER command can be used to output the ARB waveform in memory.



Note

The integer values (± 511) correspond to the maximum and minimum peak amplitudes of the waveform. For instance, for a waveform with an amplitude of 5Vpp (0 offset), the value 511 is the equivalent of 2.5 Volts and -511 is the equivalent of -2.5V. If the integer values do not span the full output range, the peak amplitude will be limited. The IEEE-488.2 binary block format is comprised of three parts:

- | | |
|------|---|
| #216 | a. Initialization character (#) |
| | b. Digit length (in ASCII) of the number of bytes |
| abc | c. Number of bytes |

IEEE 488.2 binary block format uses two bytes to

represent waveform data (16 bit integer). Therefore the number of bytes is always twice the number of data points. In the example above, the data block represents 8 data points.

Syntax	DATA:DAC VOLATILE, 0, {<binary block> <value>, <value>, . . . }
Parameter	<binary block> Points 2~4096 in binary block format <value> Decimal or integer values ± 511
Example1	DATA:DAC VOLATILE, 0, #216 Binary Data The command above downloads 8 integer points stored in 16 bytes to memory using the binary block format.
Example2	DATA:DAC VOLATILE, 0, 511, 206, 0, -206, -511, -206, 0, 206 The command above downloads the data values (511, 206, 0, -206, -511, -206, 0, 206) to memory using the ordered list method.

4-3-11. Save and Recall Commands

Up to 10 different instrument states can be stored to non-volatile memory (# 0~9) and up to 10 different ARB waveforms can be saved to memory locations 10~19.

4-3-11-1. *SAV

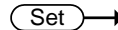

Description	Saves the current instrument state to a specified save location or an ARB waveform to the specified location. When a state is saved, all the current instrument settings, functions, modulation parameters and waveforms are also saved. Memory locations 0~9, save the instrument state only, whilst memory locations 10~19 save ARB data.
-------------	--



Note

The *RST command will not delete saved instrument states from memory.

Syntax	*SAV {NR1}
Parameter	0~9 Save state 10~19 Save ARB data
Example	*SAV 0 Save the instrument state to memory location 0.

4-3-11-2. *RCL

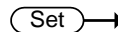

Description	Recall previously saved instrument states from memory locations 0~9 or recall the previously saved ARB waveforms from memory locations 10~19.
-------------	---

Syntax	*RCL {NR1}
--------	-------------------

Parameter	0~9	Recall state
	10~19	Recall ARB data

Example ***RCL 0**
Recall the instrument state from memory location 0
(assuming location 0 has been previously saved).

5. APPENDIX

5-1. Error Messages

The FGX-2000 has a number of specific error codes. If a setting error occurs whilst using the function generator, an error message will be momentarily displayed on the screen.

Error code	Description
E01	Frequency forced duty cycle change.
E02	Frequency reduced for ramp function
E03	Frequency made compatible with FM
E04	Frequency made compatible with FSK
E05	Frequency made compatible with Sweep
E06	Mod function cannot be performed under current setting
E07	Frequency over range
E08	Frequency over resolution
E09	Amplitude over range
E10	Amplitude over resolution
E11	Offset over range
E12	Offset over resolution
E13	Duty over range
E14	Duty over resolution
E15	ARB frequency over range
E16	ARB frequency over resolution
E17	ARB rate over range
E18	ARB rate over resolution
E19	ARB point over range
E20	ARB point over resolution
E21	ARB value over range
E22	ARB value over resolution
E23	Mod rate over range
E24	Mod rate over resolution
E25	Mod sym over range
E26	Mod sym over resolution
E27	AM depth over range
E28	AM depth over resolution
E29	FM deviation over range
E30	FM deviation over resolution
E31	FSK hop frequency over range
E32	FSK hop frequency over resolution
E33	Sweep frequency over range
E34	Sweep frequency over resolution
E35	Sweep rate over range
E36	Sweep rate over resolution
E37	Save setting over setting number range
E38	Recall setting over setting number range
E39	Recall set has no data
E40	Value over resolution
E41	Queue overflow

5-2. FGX-2000 Series Specifications

The specifications apply when the function generator is powered on for at least 30 minutes under +20°C~+30°C.

Unless otherwise specified, the specifications to apply the 50Ω load.

models	FGX-2005	FGX-2112	
Waveforms	Sine, Square, Ramp, Noise, ARB		
Arbitrary Functions			
	Sample Rate	20 MSa/s	
	Repetition Rate	10MHz	
	Waveform Length	4k points	
	Amplitude Resolution	10 bits	
	Non-Volatile Memory	4k points	
Frequency Characteristics			
Range	Sine	0.1Hz~5MHz	0.1Hz~12MHz
	Square	0.1Hz~5MHz	0.1Hz~12MHz
	Triangle, Ramp		1MHz
Resolution		0.1Hz	
Accuracy	Stability	±20 ppm	
	Aging	±1 ppm, per 1 year	
	Tolerance	≤ 1 mHz	
Output Characteristics			
Amplitude	Range	1 mVpp to 10 Vpp (into 50Ω)	
		2 mVpp to 20 Vpp (open-circuit)	
	Accuracy	± 2% of setting ±1 mVpp (at 1 kHz, Sin Wave)	
	Resolution	1 mV or 3 digits	
	Flatness	± 1% (0.1dB) ≤100kHz	
		± 3% (0.3 dB) ≤5MHz	
± 5% (0.4 dB) ≤12MHz (sine wave relative to 1 kHz)			
	Units	Vpp, Vrms, dBm	
Offset	Range	±5 Vpk ac +dc (into 50Ω)	
		±10Vpk ac +dc (Open circuit)	
	Accuracy	2% of setting + 5 mV+ 0.5% of amplitude	
Waveform Output	Impedance	50Ω typical (fixed)	
		> 300kΩ (output disabled)	
	Attenuator	—	
	Protection	Short-circuit protected	
		Overload relay automatically disables main output	
	SYNC Output	Level	TTL-compatible into >1kΩ
Impedance		50Ω nominal	
Fan Out		—	
Rise of Fall Time		≤ 25ns	

Sine wave Characteristics			
Harmonic distortion	-55 dBc	DC ~ 200kHz,	Ampl > 0.1Vpp
	-50 dBc	200kHz ~ 1MHz,	Ampl > 0.1Vpp
	-35 dBc	1MHz ~ 5MHz,	Ampl > 0.1Vpp
	-30 dBc	5MHz ~ 12MHz,	Ampl > 0.1Vpp
Square wave Characteristics			
Rise/Fall Time	≤25ns at maximum output.(into 50 Ω load)		
Overshoot	< 5%		
Asymmetry (@50% Duty)	1% of period +1 ns		
Variable duty Cycle	1.0% to 99.0% ≤100kHz		
	20.0% to 80.0% ≤ 5MHz		
	40.0% to 60.0% ≤ 10MHz		
	50% ≤ 12MHz		
Ramp Characteristics			
Linearity	< 0.1% of peak output		
Variable Symmetry	0% to 100% (0.1% Resolution)		
AM Modulation			
Carrier Waveforms	—	Sine, Square, Ramp	
Modulating Waveforms	—	Sine, Square, Ramp	
Modulating Frequency	—	2mHz to 20kHz (Int)	
		DC to 20kHz (Ext)	
Depth	—	0% to 120.0%	
Source	—	Internal / External	
FM Modulation			
Carrier Waveforms	—	Sine, Square, Ramp	
Modulating Waveforms	—	Sine, Square, Ramp	
Modulating Frequency	—	2mHz to 20kHz (Int)	
		DC to 20kHz (Ext)	
Peak Deviation	—	DC to Max Frequency	
Source	—	Internal / External	
Sweep			
Waveforms	—	Sine, Square, Ramp	
Type	—	Linear or Logarithmic	
Start/Stop Freq	—	0.1Hz to Max Frequency	
Sweep Time	—	1ms to 500s	
Source	—	Internal / External	
FSK			
Carrier Waveforms	—	Sine, Square, Ramp	
Modulating Waveforms	—	50% duty cycle square	
Modulation Rate	—	2mHz to 100 kHz (INT)	
		DC to 100 kHz(EXT)	
Frequency Range	—	0.1Hz to Max Frequency	
Source	—	Internal / External	
Frequency Counter			
Range	—	5Hz to 150MHz	

Accuracy	—	Time Base accuracy±1count
Time Base	—	±20ppm (23°C ±5°C) after 30 minutes warm up
Resolution	—	The maximum resolution is: 100nHz for 1Hz, 0.1Hz for 100MHz.
Input Impedance	—	1kΩ/1pf
Sensitivity	—	35mVrms ~ 30Vms (5Hz to 150MHz)
Save/ Recall	10 Groups of Setting Memories (Locations 0~9 only for instrument state, Locations 10~19 only for ARB data)	
Interface	USB (CDC Device)	
Display	LCD	
General Specifications		
Power Source	AC100~240V, 50~60Hz	
Power Consumption	25 VA (Max)	
Operating Environment	Temperature to satisfy the specification : 18 ~ 28°C Operating temperature :0 ~ 40°C Relative Humidity: ≤ 80%, 0 ~ 40°C ≤ 70%, 35 ~ 40°C Installation category : CAT II	
Operating Altitude	2000 Meters	
Storage Temperature	-10~70°C, Humidity: ≤80%	
Dimensions (WxHxD)	266(W) x 107(H) x 293(D) mm	
Weight	Approx. 2.5kg	
Accessories	GTL-101× 1	GTL-101× 2
	CD (user manual + software) ×1	
	Power cord×1	

5-3. External Dimensions Figure

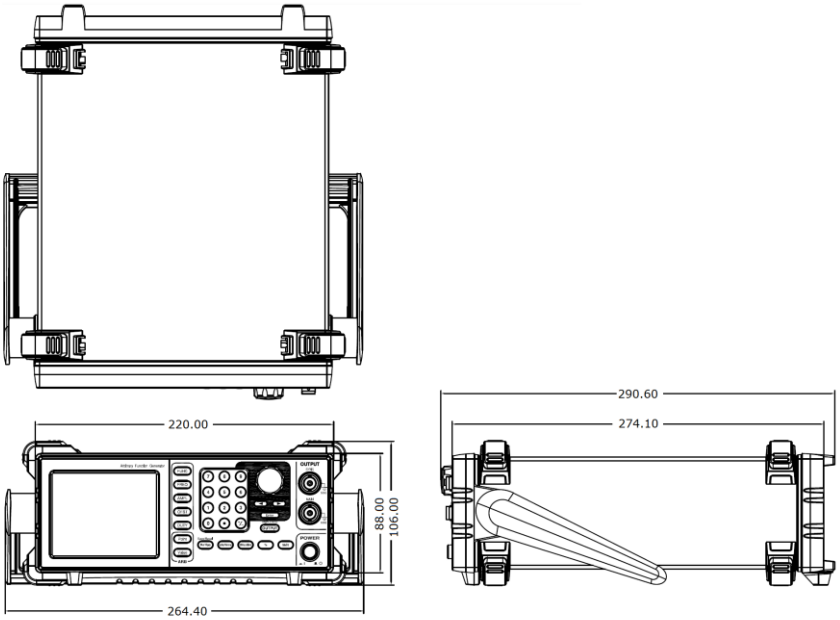



TEXIO TECHNOLOGY CORPORATION

7F Towa Fudosan Shin Yokohama Bldg., 2-18-13, Shin Yokohama, Kohoku-ku,
Yokohama, Kanagawa, 222-0033, Japan.

<http://www.texio.co.jp/>
