

PROGRAMMING MANUAL

ELECTRONIC LOAD LSG SERIES

LSG-175 LSG-350 LSG-1050



■ **About a trademark, a registered trademark**

A company name and the brand name mentioned in this instruction manual are the trademark or the registered trademark of each company or group in each country and region.

■ **About this instruction manual**

When copying the part or all of contents of this instruction manual, seek the copyright holder.

In addition, the specifications of the product and the contents of this instruction manual are subject to change without notice for improvement. Please check to our website for the latest version.

■ **About Version of LSG Series**

This manual will correspond to the Ver 1.27 the firmware of LSG series. There is some difference from specifications of firmware Ver1.01. Please refer to the change history of the appendix.

CONTENTS

1. INTERFACE OVERVIEW	1
1-1. Front Panel Overview	1
1-2. Rear Panel Overview	1
2. INTERFACE Configure	2
2-1. Configuring the USB Interface	2
2-2. Configuring the RS-232C Interface	2
2-3. Configuring the GP-IB Interface	3
2-4. RS-232C/USB Remote Control Function Check	4
2-5. Using Realterm to Establish a Remote Connection ...	4
2-6. GP-IB Function Check	6
3. COMMAND OVERVIEW	8
3-1. Command Syntax	8
4. COMMAND DETAILS	11
4-1. Common Commands	11
4-1-1. *CLS	11
4-1-2. *ESE	11
4-1-3. *ESR	11
4-1-4. *IDN	12
4-1-5. *OPC	12
4-1-6. *RCL	12
4-1-7. *RST	13
4-1-8. *SAV	13
4-1-9. *SRE	13
4-1-10. *STB	14
4-1-11. *TRG	14
4-1-12. *TST	14
4-2. Input Commands	15
4-2-1. :ABORt	15
4-2-2. :INITiate:CONTInuous	15
4-2-3. :INITiate[:IMMediate]	15
4-2-4. :INPut	16
4-2-5. [:INPut]:SHORT	17
4-2-6. :INPut:MODE	17
4-2-7. :INPut[:STATe]:TRIGered	17
4-3. Measurement Commands	18
4-3-1. :MEASure:CURRent	18
4-3-2. :MEASure:ETIME	18
4-3-3. :MEASure:POWER	18
4-3-4. :MEASure:VOLTage	19

4-4. Configure Subsystem Commands	20
4-4-1. [:CONFigure]:OCP	20
4-4-2. [:CONFigure]:OPP	20
4-4-3. [:CONFigure]:UVP	21
4-4-4. [:CONFigure]:OVP	22
4-4-5. [:CONFigure]:SStart.....	22
4-4-6. [:CONFigure]:VON	23
4-4-7. [:CONFigure]:VDElay.....	23
4-4-8. :CONFigure:RESPonse	24
4-4-9. [:CONFigure]:CNTime.....	24
4-4-10. [:CONFigure]:COTime	24
4-4-11. [:CONFigure]:CRUnit	25
4-4-12. :CONFigure:DYNamic.....	25
4-4-13. :CONFigure:MEMory	26
4-4-14. :CONFigure:SHORT	26
4-4-15. [:CONFigure]:GNG:SPECTest.....	27
4-4-16. [:CONFigure]:GNG:DTIME.....	28
4-4-17. [:CONFigure]:GNG:Mode.....	28
4-4-18. [:CONFigure]:GNG[PASS].....	29
4-4-19. [:CONFigure]:GNG:H	29
4-4-20. [:CONFigure]:GNG:L.....	29
4-4-21. [:CONFigure]:GNG:C	30
4-5. Parallel Commands	31
4-5-1. [:CONFigure]:PARAllel.....	31
4-6. Step Commands	31
4-6-1. [:CONFigure]:STEP:CC	31
4-6-2. [:CONFigure]:STEP:CCH.....	32
4-6-3. [:CONFigure]:STEP:CCM	32
4-6-4. [:CONFigure]:STEP:CCL	33
4-6-5. [:CONFigure]:STEP:CR	33
4-6-6. [:CONFigure]:STEP:CRH.....	33
4-6-7. [:CONFigure]:STEP:CRM	34
4-6-8. [:CONFigure]:STEP:CRL	34
4-6-9. [:CONFigure]:STEP:CV	35
4-6-10. [:CONFigure]:STEP:CVH.....	35
4-6-11. [:CONFigure]:STEP:CVL	36
4-6-12. [:CONFigure]:STEP:CP	36
4-6-13. [:CONFigure]:STEP:CPH.....	37
4-6-14. [:CONFigure]:STEP:CPM	37
4-6-15. [:CONFigure]:STEP:CPL	38
4-7. External Control Commands	38
4-7-1. [:CONFigure]:EXTernal[:CONTRol].....	38
4-7-2. [:CONFigure]:EXTernal:LOAdonin	39
4-7-3. [:CONFigure]:EXTernal:SYNC	39
4-8. Mode Subsystem Commands	40
4-8-1. :MODE	40
4-8-2. [:MODE]:CRANge.....	40

4-8-3. [:MODE]:VRANge	41
4-8-4. [:MODE]:RESPonse.....	41
4-8-5. [:MODE]:DYNamic	41
4-9. Current Subsystem Commands	42
4-9-1. :CURRent[:VA].....	42
4-9-2. :CURRent[:VA]:TRIGgered	42
4-9-3. :CURRent:VB.....	43
4-9-4. :CURRent:SRATe	43
4-9-5. :CURRent:L1.....	44
4-9-6. :CURRent:L2.....	44
4-9-7. :CURRent:SET.....	45
4-9-8. :CURRent:LEVel.....	45
4-9-9. :CURRent:RISE	46
4-9-10. :CURRent:FALL	46
4-9-11. :CURRent:T1	47
4-9-12. :CURRent:T2	47
4-9-13. :CURRent:FREQUency	48
4-9-14. :CURRent:DUTY	48
4-10. Resistance Subsystem Commands	49
4-10-1. :RESistance[:VA]	49
4-10-2. :RESistance[:VA]:TRIGgered.....	50
4-10-3. :RESistance:VB	50
4-10-4. :RESistance:SRATe.....	50
4-10-5. :RESistance:L1	51
4-10-6. :RESistance:L2	51
4-10-7. :RESistance:SET	52
4-10-8. :RESistance:LEVel.....	52
4-10-9. :RESistance:RISE	53
4-10-10. :RESistance:FALL.....	53
4-10-11. :RESistance:T1	54
4-10-12. :RESistance:T2	54
4-10-13. :RESistance:FREQUency.....	55
4-10-14. :RESistance:DUTY	55
4-10-15. :CONDuctance[:VA]	56
4-10-16. :CONDuctance [:VA]:TRIGgered	56
4-10-17. :CONDuctance:VB	57
4-10-18. :CONDuctance:L1	57
4-10-19. :CONDuctance:L2.....	58
4-10-20. :CONDuctance:SET	58
4-11. Voltage Subsystem Commands	59
4-11-1. :VOLTage[:VA].....	59
4-11-2. :VOLTage:VB.....	60
4-12. Power Subsystem Commands	61
4-12-1. :POWer[:VA]	61
4-12-2. :POWer:VB	61
4-12-3. :POWer:L1	62
4-12-4. :POWer:L2	62

4-12-5. :POWer:SET	63
4-12-6. :POWer:LEVel.....	63
4-12-7. :POWer:T1	64
4-12-8. :POWer:T2	64
4-12-9. :POWer:FREQuency.....	65
4-12-10. :POWer:DUTY	65
4-13. Program Commands	66
4-13-1. : PROGram	66
4-13-2. [:PROGram]:CHAIIn	67
4-13-3. [:PROGram]:CHAIIn:P2P	68
4-13-4. [:PROGram]:CHAIIn[:RECall]:DEFault	68
4-13-5. [:PROGram]:CHAIIn:STARt	68
4-13-6. :PROGram:MEMory	69
4-13-7. :PROGram:OFFTime	69
4-13-8. :PROGram:ONTime	70
4-13-9. :PROGram:PFTIME.....	70
4-13-10. :PROGram[:RECall]:DEFault	71
4-13-11. :PROGram:RUN	71
4-13-12. :PROGram:SAVE	71
4-13-13. :PROGram:STARt.....	71
4-13-14. :PROGram:STATe	72
4-13-15. :PROGram:STEP	72
4-13-16. :PROGram:STIME.....	73
4-14. Normal sequence Commands	74
4-14-1. :NSEquence	74
4-14-2. :NSEquence:CHAIIn.....	75
4-14-3. :NSEquence[:DELet]:ALL.....	76
4-14-4. :NSEquence:EDIT	76
4-14-5. :NSEquence:LAST	77
4-14-6. :NSEquence:LLOAD	78
4-14-7. :NSEquence:LOOP	78
4-14-8. :NSEquence:MEMO	79
4-14-9. :NSEquence:MODE	79
4-14-10. :NSEquence:NUMBER	79
4-14-11. :NSEquence:RANGE.....	80
4-14-12. :NSEquence:SAVE	80
4-14-13. :NSEquence:STARt	81
4-14-14. :NSEquence:STATe.....	81
4-15. Fast sequence Commands	82
4-15-1. :PFSEquence	82
4-15-2. :FSEquence[:DELet]:ALL	83
4-15-3. :FSEquence:EDIT	83
4-15-4. :FSEquence[:EDIT]:FILL	84
4-15-5. :FSEquence:LAST	85
4-15-6. :FSEquence:LLOAD	85
4-15-7. :FSEquence:LOOP	86
4-15-8. :FSEquence:MEMO	86

4-15-9. :FSEquence:MODE.....	86
4-15-10. :FSEquence:RANGe	87
4-15-11. :FSEquence:RPTStep	88
4-15-12. :FSEquence:SAVE	88
4-15-13. :FSEquence:TBASe	88
4-15-14. :FSEquence:STATe	88
4-16. OCP Test Commands.....	89
4-16-1. :OCP:STATe	89
4-16-2. :OCP:EDIT[:CHANnel]	89
4-16-3. :OCP[:CHANnel]:NUMBer	90
4-16-4. :OCP[:CHANnel]:RANGe	90
4-16-5. :OCP[:CHANnel]:START.....	91
4-16-6. :OCP[:CHANnel]:END.....	91
4-16-7. :OCP[:CHANnel]:STEP:CURRent.....	91
4-16-8. :OCP[:CHANnel]:LAST	92
4-16-9. :OCP[:CHANnel]:STEP:TIME	92
4-16-10. :OCP[:CHANnel]:DELay	93
4-16-11. :OCP[:CHANnel]:TRIGger.....	93
4-16-12. :OCP:CHANnel:STATus	93
4-16-13. :OCP:RESult	94
4-16-14. :OCP:SAVE.....	94
4-16-15. :OCP:RUN	94
4-17. Utility Commands	94
4-17-1. :UTILity:ALARm	94
4-17-2. :UTILity:BRIGhtness	95
4-17-3. :UTILity:CONTRast	95
4-17-4. :UTILity:GNG	95
4-17-5. :UTILity:KNOB	96
4-17-6. :UTILity:LANGUage.....	96
4-17-7. :UTILity:LOAD.....	96
4-17-8. :UTILity:SPEAker	98
4-17-9. :UTILity:SYStem	99
4-17-10. :UTILity:TIME	99
4-17-11. :UTILity:UNReg.....	100
4-18. Interface Commands	100
4-18-1. :UTILity:BRATe	100
4-18-2. :UTILity:INTerface.....	101
4-18-3. :UTILity:PARity.....	101
4-18-4. :UTILity:SBIT.....	101
4-19. File Commands	102
4-19-1. :FACTory[:RECall]	102
4-19-2. :MEMory:RECall	102
4-19-3. :MEMory:SAVE	102
4-19-4. :PREset:RECall.....	103
4-19-5. :PREset:SAVE	103
4-19-6. :SETup:RECall.....	103
4-19-7. :SETup:SAVE	103

4-19-8. :USER[:DEFault]:RECall	103
4-19-9. :USER[:DEFault]:SAVE	104
4-20. SCPI Status Commands	104
4-20-1. :SYSTem:ERRor	104
4-20-2. :STATus:PRESet	104
4-21. Csummary Status Commands	105
4-21-1. :STATus:CSUMmary:CONDition	105
4-21-2. :STATus:CSUMmary:ENABle	105
4-21-3. :STATus:CSUMmary[:EVENT]	105
4-21-4. :STATus:CSUMmary:NTRansition	106
4-21-5. :STATus:CSUMmary:PTRansition	106
4-22. Operation Status Commands	106
4-22-1. :STATus:OPERation:CONDition	106
4-22-2. :STATus:OPERation:ENABle	107
4-22-3. :STATus:OPERation [:EVENT]	107
4-22-4. :STATus:OPERation:NTRansition	107
4-22-5. :STATus:OPERation:PTRansition	108
4-23. Questionable Status Commands	108
4-23-1. :STATus:QUESTionable:CONDition	108
4-23-2. :STATus:QUESTionable:ENABle	108
4-23-3. :STATus:QUESTionable [:EVENT]	109
4-23-4. :STATus:QUESTionable:NTRansition	109
4-23-5. :STATus:QUESTionable:PTRansition	109
5. Status Register Overview	111
5-1. Introduction to the Status Registers	111
5-2. Configuration in the Status register	112
5-3. Csummary Status Register Group	113
5-4. Operation Status Register Group	114
5-5. Questionable Status Register Group	115
5-6. Standard Event Status Register Group	116
5-7. Status Register Group	118
6. Appendix	120
6-1. ERROR MESSAGE	120
6-2. Change History	125

1.INTERFACE OVERVIEW

This manual describes how to use the LSG Series remote command functionality and lists the command details.

1-1.Front Panel Overview

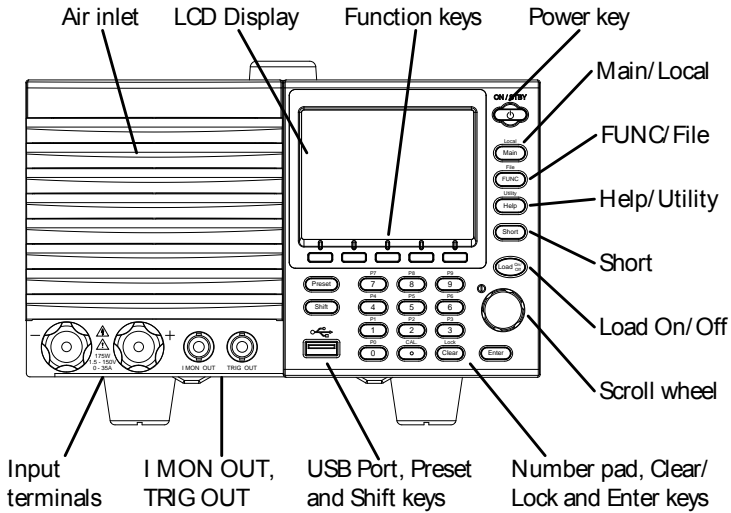

1-2.Rear Panel Overview

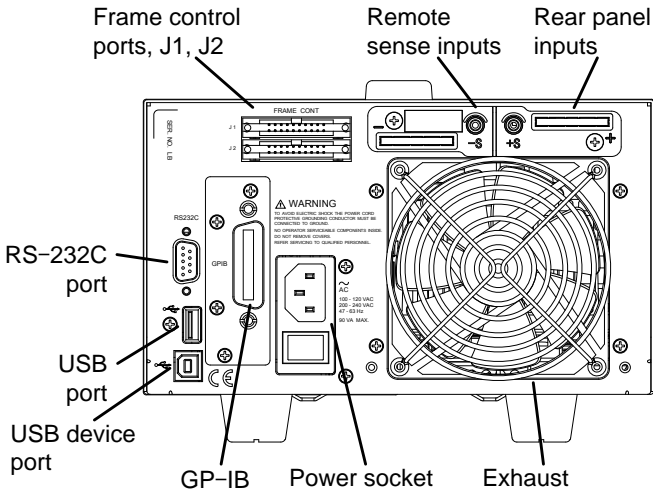

2.INTERFACE Configure

2-1.Configuring the USB Interface

USB	PC side connector	Type A, host
	LSG side connector	Rear panel Type B, device port
	Speed	2.0 (full speed)
	USB Class	USB CDC





Note

Before USB can be used for remote control, it is necessary to install the USB device driver, located on the accompanying User Manual CD.

Operation

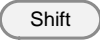
1. Connect the USB cable to the rear panel USB B port.

2. Press  +  > *Interface*[F3] and set the Interface setting to USB.
Please refer to the instruction manual for more information.

2-2.Configuring the RS-232C Interface

RS-232C	Connector	DB-9, Male
	Baud Rate	2400, 4800, 9600, 19200, 38400
	Stop Bit	1, 2
	Parity	None, Odd, Even

Operation

1. Connect an RS-232C cable from the PC to the rear panel RS-232C port.

2. Press  +  > *Interface*[F3] and set the *Interface* setting to RS232.
3. Set the *Baud Rate*, *Stop Bit* and *Parity* settings.

Pin Assignment

- | | | | | | |
|---|---|---|---|--------------------------|-----------------------|
| 1 | 2 | 3 | 4 | 5 | 2: RxD (Receive data) |
| 6 | 7 | 8 | 9 | 3: TxD (Transmit data) | |
| | | | | 5: GND | |
| | | | | 4,6,7,8,9: No connection | |

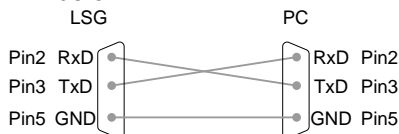

PC Connection

Use a null modem connection as shown in the diagram below.



2-3. Configuring the GP-IB Interface

To use GP-IB, the optional GP-IB port must be installed.

- Operation Ensure the LSG Series is off before proceeding.
1. Connect a GP-IB cable from a GP-IB controller to the GP-IB port on the LSG Series.
 2. Turn the LSG Series on.
 3. Press  +  > *Interface[F3]* and set the *Interface* setting to *GP-IB*.
 4. Set the GP-IB address.
GP-IB address 0~30

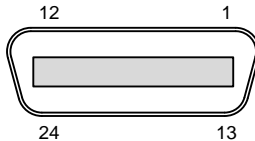

- GP-IB constraints
- *Maximum 15 devices altogether, 20m cable length, 2m between each device*
 - *Unique address assigned to each device*
 - *At least 2/3 of the devices turned On*
 - *No loop or parallel connection*

Pin Assignment



Pin	Signal	Pin	Signal
1~4	Data I/O 1~4	13~16	Data I/O 5~8
5	EOI	17	REN
6	DAV	18	Ground (DAV)
7	NRFD	19	Ground (NRFD)
8	NDAC	20	Ground (NDAC)
9	IFC	21	Ground (IFC)
10	SRQ	22	Ground (SRQ)
11	ATN	23	Ground (ATN)
12	SHIELD Ground	24	Single GND

2-4.RS-232C/USB Remote Control Function Check

Functionality check	Invoke a terminal application such as Realterm or Putty. For RS-232C, set the COM port, baud rate, stop bit, data bit and parity accordingly. To check the COM settings in Windows, see the Device Manager from ControlPanel.
 Note	For you are not familiar with using a terminal application to send/receive remote commands from the serial port or via a USB connection. Run this query command via the terminal after the instrument has been configured for RS-232/USB remote control. *idn? This should return the Manufacturer, Model number, Serial number, and Firmware version in the following format. <i>TEXIO,LSG SERIES,XXXXXXXXXXXX, V.X.X.X.X</i> Manufacturer: TEXIO Model number : LSG SERIES Serial number : XXXXXXXXXXXXX Firmware version : V.X.X.X
 Note	For further details, please see the programming manual, available on the TEXIO TECHNOLOGY web site www.texio.co.jp

2-5.Using Realterm to Establish a Remote Connection

Background	Realterm is a terminal program that can be used to communicate with a device attached to the serial port of a PC or via an emulated serial port via USB. The following instructions apply to version 1.99.0.27. Even though Realterm is used as an example to establish a remote connection, any terminal program can be used that has similar functionality.
 Note	Realterm can be downloaded on Sourceforge.net free of charge. For more information please see http://realterm.sourceforge.net/
Operation	<ol style="list-style-type: none">1. Download Realterm and install according to the instructions on the Realterm website.2. Connect the LSG Series via USB or via RS-232C3. If using RS-232C, make note of the configured baud rate, stop bits and parity.4. Go to the Windows device manager and find the COM port number for the connection. Double click the <i>Ports</i> icon to reveal the connected serial port devices and the COM port for the each connected device.

The baud rate, stop bit and parity settings can be viewed by right-clicking connected device and selecting the *Properties* option.

5. Start Realterm on the PC as an administrator.
Click:
Start menu>All Programs>RealTerm>realterm

Tip: to run as an administrator, you can right click the Realterm icon in the Windows Start menu and select the *Run as Administrator* option.

6. After Realterm has started, click on the *Port* tab.
Enter the *Baud*, *Parity*, *Data bits*, *Stop bits* and *Port* number configuration for the connection.
The *Hardware Flow Control*, *Software Flow Control* options can be left at the default settings.
Press *Open* to connect to the LSG Series.

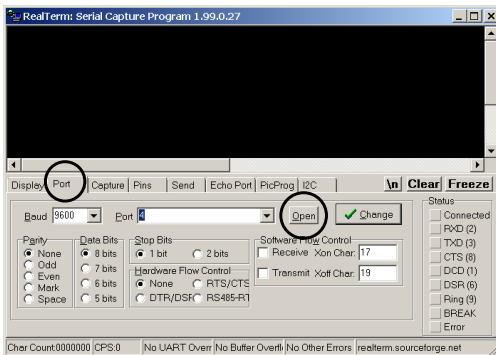

7. Click on the *Send* tab.
In the *EOL* configuration, check on the *+CR* and *+LF* check boxes.

Enter the query:

**idn?*

Click on *Send ASCII*.

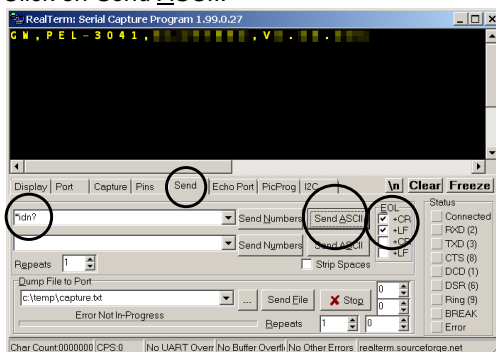

8. The terminal display will return the following:
TEXIO, LSG-XXXX, EXXXXXXXXX, VX.XX.XXX
(manufacturer, model, serial number, version)
9. If Realterm fails to connect to the LSG Series, please check all the cables and settings and try again.

2-6.GP-IB Function Check

Functionality check	Please use the National Instruments Measurement & Automation Controller software to confirm GP-IB functionality. See the National Instrument website, http://www.ni.com for details.
 Note	For further details, please see the programming manual, available on the TEXIO TECHNOLOGY web site www.texio.co.jp
Operation	<ol style="list-style-type: none"> 1. Start the NI Measurement and Automation Explorer (MAX) program. Using Windows, press: <i>Start>All Programs>National Instruments>Measurement & Automation</i>

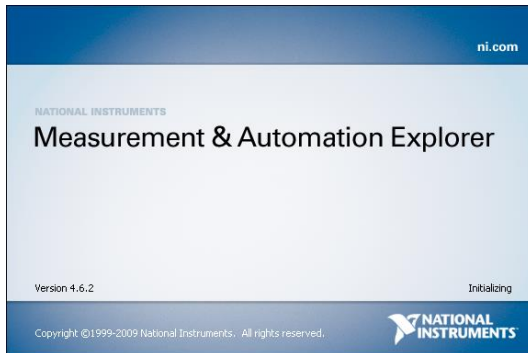

2. From the Configuration panel access;
My System>Devices and Interfaces>GPIB0
3. Press the *Scan for Instruments* button.
4. In the *Connected Instruments* panel the LSG Series should be detected as *Instrument 0* with the address the same as that configured on the LSG Series.
5. Double click the *Instrument 0* icon.

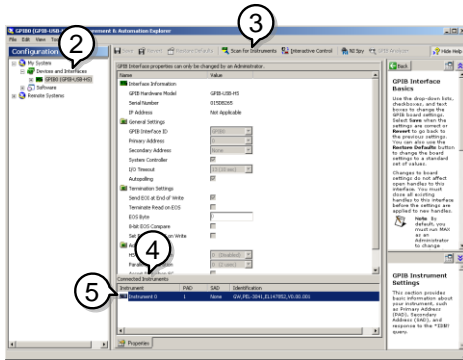

6. Click on *Communicate with Instrument*.
7. In the *NI-488.2 Communicator* window, ensure **IND?* is written in the *Send String* text box.
Click on the *Query* button to send the **IDN?* query to the instrument.
8. The *String Received* text box will display the query return: *TEXIO, LSG-XXXX,EXXXXXXXXXX, VX.XX.XXX* (manufacturer, model, serial number, version)

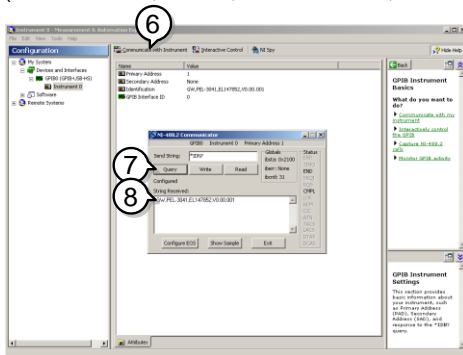

9. The function check is complete.

3.COMMAND OVERVIEW

The command syntax section shows you the basic syntax rules you have to apply when using commands.

3-1.Command Syntax

Compatible Standard	IEEE488.2 SCPI, 1999	Partial compatibility Partial compatibility
Command Structure	<p>SCPI (Standard Commands for Programmable Instruments) commands follow a tree-like structure, organized into nodes. Each level of the command tree is a node. Each keyword in a SCPI command represents each node in the command tree. Each keyword (node) of a SCPI command is separated by a colon (:).</p> <p>For example, the diagram below shows an SCPI sub-structure and a command example.</p>	

[:MODE]:CRANGe

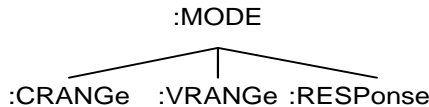

Command types	<p>There are a number of different instrument commands and queries. A command sends instructions or data to the unit and a query receives data or status information from the unit.</p> <p>Command types</p>	
	Simple	A single command with/without a parameter
	Example	:CONFigure:RESPonse MAX
	Query	A query is a simple or compound command followed by a question mark (?). A parameter (data) is returned.
	Example	:CONFigure:RESPonse?
	Compound	Two or more commands on the same command line. Compound commands are separated with either a semi-colon (;) or a semi-colon and a colon (;:). A semi-colon is used to join two related commands, with the caveat

	<p>that the last command must begin at the last node of the first command.</p> <p>A semi-colon and colon are used to combine two commands from different nodes.</p> <p>Example CONFigure:VON MAX::CONFigure:VDElay MIN</p>																		
Command Forms	<p>Commands and queries have two different forms, long and short. The command syntax is written with the short form of the command in capitals and the remainder (long form) in lower case.</p> <p>The commands can be written in capitals or lower-case, just so long as the short or long forms are complete. An incomplete command will not be recognized.</p> <p>Below are examples of correctly written commands.</p> <table border="1"> <thead> <tr> <th>Long form</th> <th>Short form:</th> </tr> </thead> <tbody> <tr> <td>:CURRENT:LEVEL?</td> <td>:CURR:LEV?</td> </tr> <tr> <td>:current:level?</td> <td>:curr:lev?</td> </tr> </tbody> </table>	Long form	Short form:	:CURRENT:LEVEL?	:CURR:LEV?	:current:level?	:curr:lev?												
Long form	Short form:																		
:CURRENT:LEVEL?	:CURR:LEV?																		
:current:level?	:curr:lev?																		
Square Brackets	<p>Commands that contain square brackets indicate that the contents are optional. The function of the command is the same with or without the square bracketed items, as shown below</p> <p>For example for the query: “[:CONFigure]:GNG [:PASS]?”</p> <p>Both “:CONFigure:GNG:PASS?” and “:GNG?” are both valid forms.</p>																		
Command Format	<p>:CURRent:Set 1.00A</p> <p>1. Command header 3. Parameter 1 2. Space 4. Unit or suffix.</p>																		
Common Input Parameters	<table border="1"> <thead> <tr> <th>Type</th> <th>Description</th> <th>Example</th> </tr> </thead> <tbody> <tr> <td><Boolean></td> <td>boolean logic</td> <td>0, 1</td> </tr> <tr> <td><NR1></td> <td>integers</td> <td>0, 1, 2, 3</td> </tr> <tr> <td><NR2></td> <td>decimal numbers</td> <td>0.1, 3.14, 8.5</td> </tr> <tr> <td><NR3></td> <td>floating point</td> <td>4.5e-1, 8.25e+1</td> </tr> <tr> <td><NRf></td> <td>any of NR1, 2, 3</td> <td>1, 1.5, 4.5e-1</td> </tr> </tbody> </table>	Type	Description	Example	<Boolean>	boolean logic	0, 1	<NR1>	integers	0, 1, 2, 3	<NR2>	decimal numbers	0.1, 3.14, 8.5	<NR3>	floating point	4.5e-1, 8.25e+1	<NRf>	any of NR1, 2, 3	1, 1.5, 4.5e-1
Type	Description	Example																	
<Boolean>	boolean logic	0, 1																	
<NR1>	integers	0, 1, 2, 3																	
<NR2>	decimal numbers	0.1, 3.14, 8.5																	
<NR3>	floating point	4.5e-1, 8.25e+1																	
<NRf>	any of NR1, 2, 3	1, 1.5, 4.5e-1																	

[MIN]
(Optional parameter) For commands, this will set the setting to the lowest value. This parameter can be used in place of any numerical parameter where indicated.

For queries, it will return the lowest possible value allowed for the particular setting.

[MAX]
(Optional parameter) For commands, this will set the setting to the highest value. This parameter can be used in place of any numerical parameter where indicated.

For queries, it will return the highest possible value allowed for the particular setting.

Unit Suffixes
(Optional parameters) Unit suffixes can be optionally used with most NRf type input parameters.

[A]	Amps	1.00A
[%]	Percentage	10%
[V]	Volts	5.00V
[W]	Watts	3.00W
[ms]	milliseconds	20ms
[mV]	Millivolts	150mV
[s]	Seconds	5s
[ohm]	Ohm	50ohm
[mS]	Reciprocal of 1k ohms	20mS
[MHO]	Reciprocal of one ohm	0.02MHO
[mA/uS]	Millamps/microsecond	100mA/uS
[Hz]	Hertz	6.0e+1Hz

Message Terminator	LF	Line feed code (0x0A)
--------------------	----	-----------------------

4.COMMAND DETAILS

4-1.Common Commands

4-1-1. *CLS

Set →

Description Clears all Event registers and queues.

Syntax *CLS

Example *CLS

Clears all Event registers and queues.

Set →

4-1-2. *ESE

→ Query

Description Queries or sets the Standard Event Status Enable register. The Standard Event Status Enable register determines which events can set the Event Summary bit (ESB) in the Status Byte Register. Any bits that are set to 1 enable the corresponding event. Each event is represented by a bit in the Standard Event Status Enable register.

Refer to the Standard Event Status register group for more information on bit.

Syntax *ESE <NRf>

Query Syntax *ESE?

Parameter <NR1> Sets the Standard Event Status Enable register.

Return parameter Return in "<NR1>" the set value of the Standard Event Status Enable register.

Example *ESE 8
Sets bit 3 of the ESE register.

Query example *ESE?
>12
Bits 2 and 3 are set in the Standard Event Status Enable register.

4-1-3. *ESR

→ Query

Description Reads the Standard Event Status register. This command will also clear the Standard Event Status register.

Refer to the Standard Event Status register group for more information on bit.

Query Syntax	*ESR?
Return parameter	Return in "<NR1>" the set value of the Standard Event Status register.
Query example	*ESR? >48 Bits 4 and 5 are set in the Standard Event register.

4-1-4. *IDN

→ Query

Description	Queries the manufacturer, model number, serial number, and firmware version of the instrument.
Query Syntax	*IDN?
Return parameter	<string> Returns the manufacture name. <string> Returns the model name. <NR1> Returns the serial number. <string> Returns the version of firmware.
Query example	* IDN? > TEXIO,LSG-175,12345678,V1.01.001 It is a response equipment manufacturer, model number, serial number, and firmware version.

Set →

4-1-5. *OPC

→ Query

Description	This command sets the OPC (Operation Command Bit) bit (bit 0) of the Standard Event Status Register after the instrument has completed all pending operations. The query will return the status of the OPC bit.
Syntax	*OPC
Query Syntax	*OPC?
Return parameter	1 Operation complete.
Example	*OPC
Query Example	*OPC? >1 Indicates that all pending operations are complete.

4-1-6. *RCL

Set →

Description	The Recall Instrument State command restores the instrument settings from a previously saved memory setting.
Syntax	*RCL <NR1>
Parameter	<NR1> Memory number 1 to 256

Example	*RCL 20 Recall setting memory 20.
Same function command	:MEMory:RECall

4-1-7. *RST



Description	Resets the unit. This is command forces the :ABORt, and *CLS.
Syntax	*RST
Example	*RST Resets the unit.

4-1-8. *SAV



Description	The Save Instrument State command saves the instrument settings to one of the memory setting slots.
Syntax	*SAV <NR1>
Parameter	<NR1> Memory number 1 to 256
Example	*SAV 20 Saves the current setting to memory 20.
Same function command	:MEMory:SAVE

4-1-9. *SRE

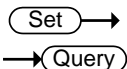

Description	Queries or sets the Service Request Enable register. The Service Request Enable register determines which events in the Status Byte register can set the Master Summary bit (MSB) in the Status Byte Register. Any bits that are set to 1 will cause the MSS bit to be set. Refer to the Status register group for more information on bit.
Syntax	*SRE <NRf>
Query Syntax	*SRE?
Parameter	<NR1> Sets the set value of the Service Request Enable register.
Return parameter	Return in "<NR1>" the set value of the Service Request Enable register.
Example	*SRE 8 Sets bit 3 of the Service Request Enable register.

Query example *SRE?
 >12
 Bits 2 and 3 are set in the Service Request Enable register.

4-1-10. *STB

→ Query

Description Reads the Status Byte register. This command will not clear the Status Byte register.
 If the Master Summary Status bit (MSS) is set, it indicates that there is a reason for a service request.
 Refer to the Status register group for more information on bit.

Query Syntax *STB?

Return parameter Return in "<NR1>" the value of the Status Byte register.

Query example *STB?

>36
 Bits 2 and 5 are set in the Status Byte register.

4-1-11. *TRG

Set →

Description This command is issue the enforcement trigger.

Syntax *TRG

Example *TRG

Issue the enforcement trigger.

Related Commands :INITiate:CONTInuous, :INITiate[:IMMEDIATE]

4-1-12. *TST

→ Query

Description This command is a standard SCPI self-test command. The LSG series does not perform any self-tests so will always return 0 (pass) for this command.

Query Syntax *TST?

Return parameter 0 Pass

Query example *TST?

>0

4-2.Trigger Commands

4-2-1. :ABORt

Set →

Description	Turns the load off. (and the loads of all connected slave devices.)
Syntax	:ABORt
Example	:ABOR Turns the load off.

Set →

4-2-2. :INITiate:CONTInuous

→ Query

Description	Query or setting for state of the continuous waiting for the trigger. Note: Release of the trigger wait state requires activation of the trigger.
Syntax	:INITiate:CONTInuous {<Boolean> OFF ON}
Query Syntax	:INITiate:CONTInuous?
Parameter	OFF or 0 Release the continuous waiting for the trigger. ON or 1 Sets to continuous waiting for the trigger.
Return parameter	Return in "<Boolean>" the set value of the continuous waiting for the trigger.
Example	:INIT:CONT ON Sets to continuous waiting for the trigger.
Query example	:INIT:CONT? >1 Setting in a continuous wait for trigger, and wait for the trigger.
Related Commands	*TRG, :INPut[:STATe]:TRIGgered, :CURRent[:VA]:TRIGgered, :RESistance[:VA]:TRIGgered

4-2-3. :INITiate[:IMMediate]

Set →

Description	Transition to waiting for a trigger. Release the trigger wait when the trigger is activated.
Syntax	:INITiate[:IMMediate]
Example	:INIT Transition to waiting for a trigger.
Related Commands	*TRG, :INPut[:STATe]:TRIGgered, :CURRent[:VA]:TRIGgered, :RESistance[:VA]:TRIGgered

Set →

→ Query

4-2-4. :TRIGger[:Delay]:Time

Description	The Trig In Delay setting determines how long to delay any action after a trigger is received.	
Syntax	:TRIGger[:Delay]:Time <NR2> MINimum MAXimum	
Query Syntax	:TRIGger[:Delay]:Time? [MINimum MAXimum]	
Parameter	<NR2>	0 ~ 0.005s (0 ~ 5000µs)
	MINimum	Minimum current limit value.
	MAXimum	Maximum current limit value.
Example	:TRIG:T MAX Set the trigger in delay to maximum.	
Query example	:TRIG:T? >0.0050000 The trigger in delay is 5ms.	

Set →

→ Query

4-2-5. :TRIGger[:PULSe]:WIDTh

Description	The Trigger Out Width setting sets the trigger output signal's pulse width.	
Syntax	:TRIGger[:PULSe]:WIDTh <NR2> MINimum MAXimum	
Query Syntax	:TRIGger[:PULSe]:WIDTh? [MINimum MAXimum]	
Parameter	<NR2>	0.0000025~0.005s (2.5µs ~ 5000µs)
	MINimum	Minimum current limit value.
	MAXimum	Maximum current limit value.
Example	:TRIG:WIDT MAX	
Query example	:TRIG:WIDT? >0.0050000 The pulse width is 5ms.	

4-3. Input Commands

Set →

→ Query

4-3-1. :INPut

Description	Query and setting for on and off load input.	
Syntax	:INPut {<Boolean> OFF ON}	
Query Syntax	:INPut?	
Parameter	OFF or 0	Sets the off the load input setting.
	ON or 1	Sets the on the load input setting.

Return parameter	Return in "<Boolean>" the set value of the load input.
Example	:INP ON Sets the on the load input setting.
Query example	:INP? > 1 Load input setting is on.

4-3-2. :INPut[:STATe]:TRIGgered

(Set) →

Description	Sets whether to turn on the load input when the trigger is activated.
Syntax	:INPut[:STATe]:TRIGgered {<Boolean> OFF ON}
Parameter	OFF or 0 Not change the load input in when the trigger active. ON or 1 Turn on the load input in when the trigger active.
Example	:INP:TRIG ON Turn on the load input in when the trigger active.
Related Commands	*TRG, :INITiate:CONTinuous, :INITiate[:IMMediate]

(Set) →

4-3-3. :INPut:SHORt

→ (Query)

Description	Query and setting for on and off load short-circuit.
Syntax	:INPut:SHORt {<Boolean> OFF ON}
Query Syntax	:INPut:SHORt?
Parameter	OFF or 0 Sets the off a short-circuit load. ON or 1 Sets the on a short-circuit load.
Return parameter	Return in "<Boolean>" the load short-circuit setting.
Example	:INP:SHOR ON Sets the on a short-circuit load.
Query example	:INP:SHOR? > 1 Load short setting is on.

(Set) →

4-3-4. :INPut:MODE

→ (Query)

Description	Query and setting for the operating mode of the load.
Syntax	:INPut:MODE { LOAD PROG NSEQ FSEQ }
Query Syntax	:INPut:MODE

Parameter	LOAD PROG NSEQ FSEQ	Sets the normal operation mode. Sets the program operation mode. Sets the normal sequence operation mode. Sets the fast sequence operation mode.
-----------	------------------------------	---

Example :INPut:MODE LOAD
Sets to normal operation mode.

Query example :INP:MODE?
>LOAD
Mode of operation is the normal operation mode.

4-4.Measurement Commands

4-4-1. :MEASure:CURRent → Query

Description	Query of current measurement.
Query Syntax	:MEASure:CURRent?
Return parameter	Return the current measurement (<NR2>). The unit is the [A].
Query example	:MEAS:CURR? >0.50000 Current measurement is 0.5A.

4-4-2. :MEASure:ETIME → Query

Description	Query of the elapsed time of the load-on.
Query Syntax	:MEASure:ETIME?
Return parameter	Return the elapsed time (<NR2>) of the load-on. The unit is the seconds.
Query example	:MEAS:ETIM? >10.0 The elapsed time of the load-on is 15 seconds.

4-4-3. :MEASure:POWer → Query

Description	Query of power measurement.
Query Syntax	:MEASure:POWer?
Return parameter	Return the current measurement (<NR2>). The unit is the [W].

Query example :MEAS:POW?
>15.00000
Power measurement is 15W.

4-4-4. :MEASure:VOLTage → Query

Description	Query of voltage measurement.
Query Syntax	:MEASure:VOLTage?
Return parameter	Return the current measurement (<NR2>). The unit is the [V].
Query example	:MEAS:VOLT? >5.00000 Voltage measurement is 5V.

4-4-5. :FETCh:CURRent → Query

Description	Query of current measurement.
Query Syntax	:FETCh:CURRent?
Return parameter	Return the current measurement (<NR2>). The unit is the [A].
Query example	:FETC:CURR? >0.50000 Current measurement is 0.5A.

4-4-6. :FETCh:POWer → Query

Description	Query of power measurement.
Query Syntax	:FETCh:POWer?
Return parameter	Return the current measurement (<NR2>). The unit is the [W].
Query example	:FETC:POW? >15.00000 Power measurement is 15W.

4-4-7. :FETCh:VOLTage → Query

Description	Query of voltage measurement.
Query Syntax	:FETCh:VOLTage?
Return parameter	Return the current measurement (<NR2>). The unit is the [V].

Query example :FETC:VOLT?
 >5.00000
 Voltage measurement is 5V.

4-5.Configure Subsystem Commands

Set →

4-5-1. [:CONFigure]:OCP

→ Query

Description	Query and setting for the OCP trip settings. The OCP limit can be set to a specific value or the trip setting can be set to either limit the current or to turn the load off.	
Syntax	[:CONFigure]:OCP {<NRf>[A] MINimum MAXimum LIMit LOFF}	
Query Syntax	[:CONFigure]:OCP?	
Parameter	<NRf>[A]	Current limit value.
	MINimum	Minimum current limit value.
	MAXimum	Maximum current limit value.
	LIMit	Limit the load.
	LOFF	Turn the load off .
Return parameter	Return the over-current limit value and the mode of operation, by the "{Load off LIMIT},<NR2>" string.	
Example1	:OCP LIM Sets the OCP setting to limit.	
Example2	:OCP 77.000 Sets the OCP value to 77A.	
Query example	:OCP? >LIMIT, 77.000 The OCP setting is LIMIT and the OCP value is 77A.	

Set →

4-5-2. [:CONFigure]:OPP

→ Query

Description	Query and setting for the OPP trip settings. The OPP limit can be set to a specific value or the trip setting can be set to either limit the power or to turn the load off.	
Syntax	[:CONFigure]:OPP {<NRf>[W] MINimum MAXimum LIMit LOFF}	
Query Syntax	[:CONFigure]:OPP?	
Parameter	<NRf>[W]	Power limit value.
	MINimum	Minimum power limit value.
	MAXimum	Maximum power limit value.
	LIMit	Limit the load
	LOFF	Turn the load off

Return parameter	Return the over-power limit value and the mode of operation, by the "{Load off LIMIT},<NR2>" string.
Example1	:OPP LIM Sets the OPP setting to limit.
Example2	:OPP 10.000 Sets the OPP value to 10W.
Query example	:OPP? >LIMIT, 10.000 The OPP setting is LIMIT and the OPP value is 10W.

Set →

→ Query

4-5-3. [:CONFigure]:UVP

Description	Query and setting for the UVP trip settings. The UVP can also be cleared with this command.
Syntax	[:CONFigure]:UVP { <NRf>[V] MINimum MAXimum}
Query Syntax	[:CONFigure]:UVP?
Parameter	<NRf>[V] Under voltage limit value. MINimum Minimum value. MAXimum Maximum value.
Return parameter	Return the set value of the UVP, by the "<NR2>" string.
Example	:UVP 10.00 Sets the UVP setting to 10V.
Query example	:UVP? >10.0000 The UVP setting is 10V.

Set →

→ Query

4-5-4. [:CONFigure]:UVP:TIME

Description	Sets or queries the UVP ring time setting
Syntax	[:CONFigure]:UVP:TIME<NR1>
Query Syntax	[:CONFigure]:UVP:TIME?
Parameter	<NR1>[s] Under voltage limit value.
Return parameter	Returns the UVP ring time (<NR1>)
Example	:UVP:TIME 5 Sets the UVP ring time to 5 seconds
Query example	:UVP:TIME? > 5 The UVP ring time is 5 seconds

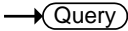
 →
 → 

4-5-5. [:CONFigure]:OVP

Description	Query and setting for the OVP trip settings. The OVP can also be cleared with this command.	
Syntax	[:CONFigure]:OVP { <NRf>[V] MINimum MAXimum }	
Query Syntax	[:CONFigure]:OVP?	
Parameter	<NRf>[V]	Over voltage limit value.
	MINimum	Minimum value.
	MAXimum	Maximum value. (OVP setting is OFF.)
Return parameter	Return the set value of the UVP, by the "{<NR2> OFF}" string. "OFF" is a function off.	
Example	:OVP 10.00 Sets the OVP setting to 10V.	
Query example	:OVP? >10.0000 The OVP setting is 10V.	

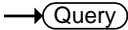
 →
 → 

4-5-6. [:CONFigure]:SStart

Description	Query and setting for the Soft Start time setting.	
Syntax	[:CONFigure]:SStart { <NRf>[S] OFF MINimum MAXimum }	
Query Syntax	[:CONFigure]:SStart?	
Parameter	<NRf>[S]	The soft start time in seconds.
	MINimum	Minimum time = 0 seconds
	MAXimum	Maximum time
	OFF	OFF = 0 seconds
Return parameter	Return the set value of the soft-start time, by the "{<NR2> OFF}" string. "OFF" is a function off.	
Example	:SST OFF Turns the soft start function off.	
Query example	:SST? >OFF The soft start function is off.	

Set →
 → Query

4-5-7. [:CONFigure]:VON

Description	Query and setting for the Von voltage settings.	
Syntax	[:CONFigure]:VON {<NRf>[V] MINimum MAXimum LON LOFF}	
Query Syntax	[:CONFigure]:VON?	
Parameter	<NRf>[V] MINimum MAXimum LON LOFF	The Von voltage level. Minimum Von voltage level. Maximum Von voltage level. Latch on. Latch off.
Return parameter	Return the Von value and the mode of operation, by the " Latch:{OFF ON},<NR2>" string.	
Example	:VON 10.0V Sets the Von voltage to 10.0 volts.	
Query example	:VON? >Latch OFF, 0.000 The Von voltage level is 10V.	

Set →
 → Query

4-5-8. [:CONFigure]:VDElay

Description	Query and setting for the Von Delay settings in seconds.	
Syntax	[:CONFigure]:VDElay {<NRf>[S] OFF MINimum MAXimum }	
Query Syntax	[:CONFigure]:VDElay?	
Parameter	<NRf>[S] OFF MINimum MAXimum	The delay time in seconds Disable the delay time Minimum delay time Maximum delay time
Return parameter	Return the set value of the delay time, by the "{<NR2> OFF}" string. "OFF" is a function off.	
Example1	:VDEL 2.5mS Sets the delay time to 2.5mS.	
Example2	:VDEL 0.0025S Sets the delay time to 2.5mS.	
Query example	:VDEL? >0.0025 The delay time is 2.5mS.	

Set →
 → Query

4-5-9. :CONFigure:RESPonse

Description	Query and setting for the response speed of the CC and CR mode.						
Syntax	:CONFigure:RESPonse{<NR2>[S] MINimum MAXimum}						
Query Syntax	:CONFigure:RESPonse?						
Parameter	<table border="0"> <tr> <td style="padding-right: 20px;"><NR2></td> <td>0.1, 0.2, 0.5, 1.0</td> </tr> <tr> <td>MINimum</td> <td>Minimum response speed</td> </tr> <tr> <td>MAXimum</td> <td>Maximum response speed</td> </tr> </table>	<NR2>	0.1, 0.2, 0.5, 1.0	MINimum	Minimum response speed	MAXimum	Maximum response speed
<NR2>	0.1, 0.2, 0.5, 1.0						
MINimum	Minimum response speed						
MAXimum	Maximum response speed						
Return parameter	Return the set value of the response speed, by the "<NR2>" string.						
Example	:CONF:RESP MAX Sets the response to the maximum of the CC and CR mode.						
Query example	:CONF:RESP? >1.0 Response speed of the CC and CR mode is 1.0.						

Set →
 → Query

4-5-10. [:CONFigure]:CNTTime

Description	Query and setting for the Count time timer function.				
Syntax	[:CONFigure]:CNTTime {OFF ON}				
Query Syntax	[:CONFigure]:CNTTime?				
Parameter	<table border="0"> <tr> <td style="padding-right: 20px;">OFF</td> <td>Turns the Count Time timer off.</td> </tr> <tr> <td>ON</td> <td>Turns the Count Time timer on</td> </tr> </table>	OFF	Turns the Count Time timer off.	ON	Turns the Count Time timer on
OFF	Turns the Count Time timer off.				
ON	Turns the Count Time timer on				
Example	:CNT ON Turns the Count Time timer on.				
Query example	:CNT? >ON Count Time is turned on.				

Set →
 → Query

4-5-11. [:CONFigure]:COTime

Description	Sets or queries the load cutoff time. A cutoff time of 0 seconds is the equivalent of disabling the cutoff time.						
Syntax	[:CONFigure]:COTime {<NRf>[S] OFF MINimum MAXimum }						
Query Syntax	[:CONFigure]:COTime?						
Parameter	<table border="0"> <tr> <td style="padding-right: 20px;"><NRf>[S]</td> <td>Cut off time in seconds (1~3599999)</td> </tr> <tr> <td>OFF</td> <td>Turns the cutoff time off.</td> </tr> <tr> <td>MINimum</td> <td>Sets the cutoff time to the maximum</td> </tr> </table>	<NRf>[S]	Cut off time in seconds (1~3599999)	OFF	Turns the cutoff time off.	MINimum	Sets the cutoff time to the maximum
<NRf>[S]	Cut off time in seconds (1~3599999)						
OFF	Turns the cutoff time off.						
MINimum	Sets the cutoff time to the maximum						

	MAXimum	Sets the cutoff time to the minimum
Return parameter	Return the set value of the Cut-off time, by the "{<NR1> OFF}" string. "OFF" is a function off.	
Example	:COT MAX Sets the cutoff time to the maximum.	
Query example	:COT? >500 The cutoff time is set to 500 seconds.	

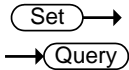

4-5-12. [:CONFigure]:CRUnit

Description	Query and setting for the CR mode setting units.	
Syntax	[:CONFigure]:CRUnit {OHM MHO}	
Query Syntax	[:CONFigure]:CRUnit?	
Parameter	OHM	Set the "Ω" to unit of the display.
	MHO	Set the "mS" to unit of the display. (Millisiemens)
Example	:CRU OHM Sets the CR mode units to ohms.	
Query example	:CRU? >OHM The CR mode units are ohms.	

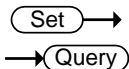

4-5-13. :CONFigure:DYNAMIC

Description	Query and setting for the setting conditions for dynamic mode. Setting conditions can select the duty cycle or the timer, the percentage or the value. Please refer to the Instruction Manual for details.	
Syntax	:CONFigure:DYNAMIC { VALue PERCent TIME FDUTy }	
Query Syntax	:CONFigure:DYNAMIC?	
Parameter	VALue	Set the units to Value.
	PERCent	Set the units to Percent.
	TIME	Use timers for timing.
	FDUTy	Use duty cycle for timing.
Return parameter	Return the unit and the timing mode, by the "{ Value Percent},{T1/T2 Fre./Duty }" string.	
Example	:CONF:DYN VAL Sets the dynamic mode units to value.	

Query example :CONF:DYN?
 >Value,T1/T2
 The dynamic mode becomes a value setup and a timer setup.

Set →

4-5-14. :CONFigure:MEMory

→ Query

Description	This command configures the how the files are recalled <i>in local mode</i> (using the front panel interface). By default when you try to recall a file or setting from memory, a message will appear asking you to press the Enter key to confirm each time you wish to recall. This command enables (SAFety) or disables this feature (DIRect).
Syntax	:CONFigure:MEMory {SAFety DIRect}
Query Syntax	:CONFigure:MEMory?
Parameter	SAFety Safety setting. DIRect Directly recall the chosen file.
Return parameter	Return the presence or absence of confirmation of recall, by the "{ Safety Direct }" string.
Example	:CONF:MEM SAF Enables the safety setting.
Query example	:CONF:MEM? >Safety The safety setting is enabled.

Set →

4-5-15. :CONFigure:SHORt

→ Query

Description	Query and setting for the short key behavior.
Syntax	:CONFigure:SHORt { TOGGle HOLD}
Query Syntax	:CONFigure:SHORt?
Parameter	HOLD Sets the button configuration to hold TOGGle Sets the button configuration to toggle
Return parameter	Return the Short Key Action, by the "{Toggle Hold}" string.
Example	:CONF:SHOR TOGG Sets the Short key configuration to toggle.
Query example	:CONF:SHOR? >Toggle The Short key is configured to toggle.

Set →
 → Query

4-5-16. :CONFigure:SHORT:SAFety

Description	Query and setting for safety short.
Syntax	:CONFigure:SHORT:SAFety { OFF ON }
Query Syntax	:CONFigure:SHORT:SAFety?
Parameter	OFF Safety off ON Safety on : the load can only be shorted when the load is already on.
Return parameter	Return the Short safety function status.
Example	:CONF:SHOR:SAF OFF Turns short safety on.
Query example	:CONF:SHOR:SAF? >OFF Indicates that Short safety is off

Set →
 → Query

4-5-17. :CONFigure:SHORT:FUNCTION

Description	Query and setting for safety function.
Syntax	CONFigure:SHORT:FUNCTION {<bool> OFF ON}
Query Syntax	:CONFigure:SHORT:FUNCTION?
Parameter	OFF Short function is disabled. ON Short function is enabled.
Return parameter	Return the Short function status.
Example	:CONF:SHOR:FUNC OFF Disable short function.
Query example	:CONF:SHOR:FUNC? >OFF Short function is disabled.

Set →
 → Query

4-5-18. [:CONFigure]:GNG:SPECTest

Description	Query and setting for the Go-NoGo testing.
Syntax	[:CONFigure]:GNG:SPECTest { OFF ON }
Query Syntax	[:CONFigure]:GNG:SPECTest?
Parameter	OFF SPEC test = OFF ON SPEC test = ON
Example	:GNG:SPECT ON Turns Go-NoGo testing on.

Query example :GNG:SPECT?
 >OFF
 Indicates that Go-NoGo testing is off.

Set →
 → Query

4-5-19. [:CONFigure]:GNG:DTIME

Description	Query and setting for the Go-NoGo delay time.	
Syntax	[:CONFigure]:GNG:DTIME {<NRf>[S] MINimum MAXimum }	
Query Syntax	[:CONFigure]:GNG:DTIME?	
Parameter	<NRf>[S]	Sets the Go-NoGo delay time in seconds (0.0~1.0) with 0.1 second resolution.
	MINimum	Minimum delay time
	MAXimum	Maximum delay time
Return parameter	Returns the delay time in seconds, by the "<NR2>" string.	
Example	:GNG:DTIM 0.5 Sets the delay time to 0.5 seconds.	
Query example	:GNG:DTIM? >0.5 The delay time is 0.5 seconds.	

Set →
 → Query

4-5-20. [:CONFigure]:GNG:Mode

Description	Query and setting for the entry mode for the Go-NoGo settings. The entry mode determines whether the Go-NoGo limits are set as values or as a percentage value from a center reference value.	
Syntax	[:CONFigure]:GNG:Mode {PERCent VALue}	
Query Syntax	[:CONFigure]:GNG:Mode?	
Parameter	PERCent	Sets the entry mode to %.
	VALue	Sets the entry mode to value
Return parameter	Returns the Setting value of Go-NoGo input mode, by the "{Percent Value}" string.	
Example	:GNG:M PERC Sets the entry mode to %.	
Query example	:GNG:M? >Percent The entry mode is %.	
Related Commands	[:CONFigure]:GNG:H [:CONFigure]:GNG:L	

4-5-21. [:CONFigure]:GNG[:PASS]

→ Query

Description	Queries the Go-NoGo test result(s). This command can be used for all test modes (CC, CV, CR, CP).
Query Syntax	[:CONFigure]:GNG[:PASS]?
Return parameter	NG No Good (Fail) GO Good (Pass)
Query example	:GNG? >GO Returns the Go-NoGo test result.

Set →

4-5-22. [:CONFigure]:GNG:H

→ Query

Description	Query and setting for the high voltage/current limit value. If the entry mode is set to value, the high voltage/current limit value units are in volts/amps. If the entry mode is set to percent, the high voltage/current limit value units are in percent.
Syntax	[:CONFigure]:GNG:H <NRf>
Query Syntax	[:CONFigure]:GNG:H?
Parameter	<NRf> Sets the high voltage/current limit value in volts/amps or in percent.
Return parameter	Returns the voltage/current upper limit value, by the "{<NR2>}" string.
Example	:GNG:H 100.0 Sets the high voltage limit value to 100%.
Query example	:GNG:H? >100.0 Returns the high voltage limit value as 100%.
Related Commands	[:CONFigure]:GNG:Mode [:CONFigure]:GNG:L

Set →

4-5-23. [:CONFigure]:GNG:L

→ Query

Description	Query and setting for the low voltage/current limit value. If the entry mode is set to value, the low voltage/current limit value units are in volts/amps. If the entry mode is set to percent, the low voltage/current limit value units are in percent.
Syntax	[:CONFigure]:GNG:L <NRf>

Query Syntax	[:CONFigure]:GNG:L?	
Parameter	<NRf>	Sets the low voltage/current limit value in volts/amps or in percent.
Return parameter	Returns the voltage/current lower limit value, by the "{<NR2>}" string.	
Example	:GNG:L 10.0 Sets the low voltage limit value to 10%.	
Query example	:GNG:L? >10.0 Returns the low voltage limit value as 10%.	
Related Commands	[:CONFigure]:GNG:Mode [:CONFigure]:GNG:H	

Set →

→ Query

4-5-24. [:CONFigure]:GNG:C

Description	Query and setting for the center voltage/current limit value. The center voltage limit value is used as the center reference value when the entry mode is set to percent.	
Syntax	[:CONFigure]:GNG:C <NRf>	
Query Syntax	[:CONFigure]:GNG:C?	
Parameter	<NRf>	Sets the center voltage/current limit value in volts/amps.
Return parameter	Returns the Center value of voltage/current, by the "{<NR2>}" string.	
Example	:GNG:C 10.0 Sets the center voltage/current limit value to 10V or A.	
Query example	:GNG:C? >10.0 Returns the center voltage/current limit value of 10V or A.	
Related Commands	[:CONFigure]:GNG:Mode	

4-6.Parallel Commands

Set →

4-6-1. [:CONFigure]:PARAllel

→ Query

Description	Configures the unit for parallel operation, or queries its state. This command configures the unit as a Master or Slave, and configures how many slave units are connected if the unit is configured as a master.	
Syntax	[:CONFigure]:PARAllel { Master Slave OFF P2 P3 P4 P5 B1 B2 B3 B4 }	
Query Syntax	[:CONFigure]:PARAllel?	
Parameter	P2,P3,P4 or P5 B1,B2,B3 or B4 OFF Master Slave	Number of connected slaves Number of connected Booster. Turn parallel mode off Sets the unit to Master Sets the unit to Slave
Return parameter	Return the connections number and mode(master / slave). Response of master mode is the " Mode:Master,{Number:OFF Parallel Number:{2 3 4 5} Booster Number: {1 2 3 4} }". Response of Slave mode is the ""Mode:Slave".	
Example 1	:PAR M Sets the unit to Master.	
Example 2	:PAR B2 Configures the unit for use with 2 booster units.	
Query example	:PAR? >Mode:Master, Number:OFF The unit is set to Master and there are no connected slaves.	

4-7.Step Commands

4-7-1. [:CONFigure]:STEP:CC

→ Query

Description	Queries the step resolution for each CC Mode range.
Query Syntax	[:CONFigure]:STEP:CC?
Return parameter	Returns the step resolution for each CC Mode range, by the "CCH:<NR2>, CCM:<NR2>, CCL:<NR2>" string.
Query example	:STEP:CC? >CCH:0.002, CCM:0.0002, CCL:0.0002 Returns the CC mode step resolution for each range.

Set →

→ Query

4-7-2. [:CONFigure]:STEP:CCH

Description	Query and settings for the step resolution for CC High Range. Note: The step resolution setting will be automatically rounded to the closest multiple of the base resolution.
Syntax	[:CONFigure]:STEP:CCH { <NRf>[A] MINimum MAXimum }
Query Syntax	[:CONFigure]:STEP:CCH?
Parameter	<NRf>[A] Step resolution. MINimum Minimum step resolution MAXimum Maximum step resolution
Return parameter	Returns the range and the step resolution, by the "CCH:<NR2>" string.
Example	:STEP:CCH 0.002A Sets the step resolution to 0.002A.
Query example	:STEP:CCH? >CCH:0.002 Returns the step resolution (0.002A).

Set →

→ Query

4-7-3. [:CONFigure]:STEP:CCM

Description	Query and settings for the step resolution for CC medium Range. Note: The step resolution setting will be automatically rounded to the closest multiple of the base resolution.
Syntax	[:CONFigure]:STEP:CCM {<NRf>[A] MINimum MAXimum }
Query Syntax	[:CONFigure]:STEP:CCM?
Parameter	<NRf>[A] Step resolution. MINimum Minimum step resolution MAXimum Maximum step resolution
Return parameter	Returns the range and the step resolution, by the "CCM:<NR2>" string.
Example	:STEP:CCM 0.0002A Sets the step resolution to 0.0002A.
Query example	:STEP:CCM? >CCM:0.0002 Returns the step resolution (0.0002A).

Set →
 → Query

4-7-4. [:CONFigure]:STEP:CCL

Description	Query and settings for the step resolution for CC low Range. Note: The step resolution setting will be automatically rounded to the closest multiple of the base resolution.						
Syntax	[:CONFigure]:STEP:CCL {<NRf>[A] MINimum MAXimum }						
Query Syntax	[:CONFigure]:STEP:CCL?						
Parameter	<table border="0"> <tr> <td style="padding-right: 10px;"><NRf>[A]</td> <td>Step resolution.</td> </tr> <tr> <td>MINimum</td> <td>Minimum step resolution</td> </tr> <tr> <td>MAXimum</td> <td>Maximum step resolution</td> </tr> </table>	<NRf>[A]	Step resolution.	MINimum	Minimum step resolution	MAXimum	Maximum step resolution
<NRf>[A]	Step resolution.						
MINimum	Minimum step resolution						
MAXimum	Maximum step resolution						
Return parameter	Returns the range and the step resolution, by the "CCL:<NR2>" string.						
Example	:STEP:CCL 0.00002A Sets the step resolution to .00002A.						
Query example	:STEP:CCL? > CCL:0.00002 Returns the step resolution (0.00002A).						

4-7-5. [:CONFigure]:STEP:CR

→ Query

Description	Queries the step resolution for each CR Mode range.
Query Syntax	[:CONFigure]:STEP:CR?
Return parameter	Returns the step resolution for each CR Mode range, by the " CRH:<NR2>, CRM:<NR2>, CRL:<NR2>" string.
Query example	:STEP:CR? >CRH:0.8, CRM:0.08, CRL:0.008 Returns the CR mode step resolution for each range.

Set →
 → Query

4-7-6. [:CONFigure]:STEP:CRH

Description	Query and settings for the step resolution for CR High Range. Note: The step resolution setting will be automatically rounded to the closest multiple of the base resolution.
Syntax	[:CONFigure]:STEP:CRH {<NRf>[mho] MINimum MAXimum }
Query Syntax	[:CONFigure]:STEP:CRH?

Parameter	<NRf>[mho] MINimum MAXimum	Step resolution. Minimum step resolution Maximum step resolution
Return parameter	Returns the range and the step resolution, by the "CRH:<NR2>" string.	
Example	:STEP:CRH 0.8 Sets the step resolution to 0.8U.	
Query example	:STEP:CRH? >CRH:0.8 Returns the step resolution (0.8U).	

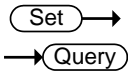

4-7-7. [:CONFigure]:STEP:CRM

Description	Query and settings for the step resolution for CR Medium Range. Note: The step resolution setting will be automatically rounded to the closest multiple of the base resolution.	
Syntax	[:CONFigure]:STEP:CRM {<NRf>[mho] MINimum MAXimum }	
Query Syntax	[:CONFigure]:STEP:CRM?	
Parameter	<NRf>[mho] MINimum MAXimum	Step resolution. Minimum step resolution Maximum step resolution
Return parameter	Returns the range and the step resolution, by the "CRM:<NR2>" string.	
Example	:STEP:CRM 0.08 Sets the step resolution to 0.08U.	
Query example	:STEP:CRM? >CRM:0.08 Returns the step resolution (0.08U).	

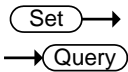

4-7-8. [:CONFigure]:STEP:CRL

Description	Query and settings for the step resolution for CR Low Range. Note: The step resolution setting will be automatically rounded to the closest multiple of the base resolution.	
Syntax	[:CONFigure]:STEP:CRL {<NRf>[mho] MINimum MAXimum }	
Query Syntax	[:CONFigure]:STEP:CRL?	

Parameter	<NRf>[mho] MINimum MAXimum	Step resolution. Minimum step resolution Maximum step resolution
Return parameter	Returns the range and the step resolution, by the "CRL:<NR2>" string.	
Example	:STEP:CRL 0.008 Sets the step resolution to 0.008 \bar{U} .	
Query example	:STEP:CRL? >CRL:0.008 Returns the step resolution (0.08 \bar{U}).	

4-7-9. [:CONFigure]:STEP:CV

→ Query

Description	Queries the step resolution for each CV Mode range.	
Query Syntax	[:CONFigure]:STEP:CV?	
Return parameter	Returns the step resolution for each CV Mode range, by the "CVH:<NR2>, CVL:<NR2>" string.	
Query example	:STEP:CV? >CVH:0.01, CVL:0.001 Returns the CV mode step resolution for each range.	

Set →

4-7-10. [:CONFigure]:STEP:CVH

→ Query

Description	Query and settings for the step resolution for CV High Range. Note: The step resolution setting will be automatically rounded to the closest multiple of the base resolution.	
Syntax	[:CONFigure]:STEP:CVH {<NRf>[V] MINimum MAXimum }	
Query Syntax	[:CONFigure]:STEP:CVH?	
Parameter	<NRf>[V] MINimum MAXimum	Step resolution. Minimum step resolution Maximum step resolution
Return parameter	Returns the range and the step resolution, by the "CVH:<NR2>" string.	
Example	:STEP:CVH 0.01V Sets the step resolution to 0.01V.	
Query example	:STEP:CVH? > CVH:0.01 Returns the step resolution (0.01V).	

Set →
 → Query

4-7-11. [:CONFigure]:STEP:CVL

Description	Query and settings for the step resolution for CV Low Range. Note: The step resolution setting will be automatically rounded to the closest multiple of the base resolution.						
Syntax	[:CONFigure]:STEP:CVL {<NRf>[V] MINimum MAXimum }						
Query Syntax	[:CONFigure]:STEP:CVL?						
Parameter	<table style="border: none;"> <tr> <td style="padding-right: 10px;"><NRf>[V]</td> <td>Step resolution.</td> </tr> <tr> <td>MINimum</td> <td>Minimum step resolution</td> </tr> <tr> <td>MAXimum</td> <td>Maximum step resolution</td> </tr> </table>	<NRf>[V]	Step resolution.	MINimum	Minimum step resolution	MAXimum	Maximum step resolution
<NRf>[V]	Step resolution.						
MINimum	Minimum step resolution						
MAXimum	Maximum step resolution						
Return parameter	Returns the range and the step resolution, by the "CVL:<NR2>" string.						
Example	:STEP:CVL 0.001V Sets the step resolution to 0.001V.						
Query example	:STEP:CVL? > CVL:0.001 Returns the step resolution (0.001V).						

4-7-12. [:CONFigure]:STEP:CP

→ Query

Description	Queries the step resolution for each CP Mode range.
Query Syntax	[:CONFigure]:STEP:CP?
Return parameter	Returns the step resolution for each CP Mode range, by the "CPH:<NR2>, CPM:<NR2>, CPL:<NR2>" string.
Query example	:STEP:CP? > CPH:0.01, CPM:0.001, CPL:0.0001 Returns the CP mode step resolution for each range.



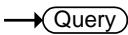

4-7-13. [:CONFigure]:STEP:CPH

Description	<p>Query and settings for the step resolution for CP High Range.</p> <p>Note: The step resolution setting will be automatically rounded to the closest multiple of the base resolution.</p>						
Syntax	[:CONFigure]:STEP:CPH {<NRf>[W] MINimum MAXimum }						
Query Syntax	[:CONFigure]:STEP:CPH?						
Parameter	<table border="0"> <tr> <td style="padding-right: 20px;"><NRf>[W]</td> <td>Step resolution.</td> </tr> <tr> <td>MINimum</td> <td>Minimum step resolution</td> </tr> <tr> <td>MAXimum</td> <td>Maximum step resolution</td> </tr> </table>	<NRf>[W]	Step resolution.	MINimum	Minimum step resolution	MAXimum	Maximum step resolution
<NRf>[W]	Step resolution.						
MINimum	Minimum step resolution						
MAXimum	Maximum step resolution						
Return parameter	Returns the range and the step resolution, by the "CPH:<NR2>" string.						
Example	<pre>:STEP:CPH 0.01</pre> <p>Sets the step resolution to 0.01W.</p>						
Query example	<pre>:STEP:CPH?</pre> <pre>>CPH:0.01</pre> <p>Returns the step resolution (0.01W).</p>						



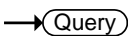

4-7-14. [:CONFigure]:STEP:CPM

Description	<p>Query and settings for the step resolution for CP Medium Range.</p> <p>Note: The step resolution setting will be automatically rounded to the closest multiple of the base resolution.</p>						
Syntax	[:CONFigure]:STEP:CPM {<NRf>[W] MINimum MAXimum }						
Query Syntax	[:CONFigure]:STEP:CPM?						
Parameter	<table border="0"> <tr> <td style="padding-right: 20px;"><NRf>[W]</td> <td>Step resolution.</td> </tr> <tr> <td>MINimum</td> <td>Minimum step resolution</td> </tr> <tr> <td>MAXimum</td> <td>Maximum step resolution</td> </tr> </table>	<NRf>[W]	Step resolution.	MINimum	Minimum step resolution	MAXimum	Maximum step resolution
<NRf>[W]	Step resolution.						
MINimum	Minimum step resolution						
MAXimum	Maximum step resolution						
Return parameter	Returns the range and the step resolution, by the "CPM:<NR2>" string.						
Example	<pre>:STEP:CPM 0.001</pre> <p>Sets the step resolution to 0.001W.</p>						
Query example	<pre>:STEP:CPM?</pre> <pre>>CPM:0.001</pre> <p>Returns the step resolution (0.001W).</p>						

Set →
 → Query

4-7-15. [:CONFigure]:STEP:CPL

Description	Query and settings for the step resolution for CP Low Range. Note: The step resolution setting will be automatically rounded to the closest multiple of the base resolution.						
Syntax	[:CONFigure]:STEP:CPL {<NRf>[W] MINimum MAXimum }						
Query Syntax	[:CONFigure]:STEP:CPL?						
Parameter	<table border="0" style="width: 100%;"> <tr> <td style="width: 30%;"><NRf>[W]</td> <td>Step resolution.</td> </tr> <tr> <td>MINimum</td> <td>Minimum step resolution</td> </tr> <tr> <td>MAXimum</td> <td>Maximum step resolution</td> </tr> </table>	<NRf>[W]	Step resolution.	MINimum	Minimum step resolution	MAXimum	Maximum step resolution
<NRf>[W]	Step resolution.						
MINimum	Minimum step resolution						
MAXimum	Maximum step resolution						
Return parameter	Returns the range and the step resolution, by the "CPL:<NR2>" string.						
Example	:STEP:CPL 0.0001 Sets the step resolution to 0.0001W.						
Query example	:STEP:CPL? >CPM:0.0001 Returns the step resolution (0.0001W).						

4-8.External Control Commands

Set →
 → Query

4-8-1. [:CONFigure]:EXTernal[:CONTrol]

Description	Query and settings for mode of the external control.								
Syntax	[:CONFi gure]:EXTernal[:CONTrol] { OFF VOLTage RESistance RINV }								
Query Syntax	[:CONFi gure]:EXTernal[:CONTrol] ?								
Parameter	<table border="0" style="width: 100%;"> <tr> <td style="width: 30%;">OFF</td> <td>Disables external control</td> </tr> <tr> <td>VOLTage</td> <td>Sets the unit to external voltage control</td> </tr> <tr> <td>RESistance</td> <td>Sets the unit to external resistance control</td> </tr> <tr> <td>RINV</td> <td>Sets the unit to external resistance (inverted) control</td> </tr> </table>	OFF	Disables external control	VOLTage	Sets the unit to external voltage control	RESistance	Sets the unit to external resistance control	RINV	Sets the unit to external resistance (inverted) control
OFF	Disables external control								
VOLTage	Sets the unit to external voltage control								
RESistance	Sets the unit to external resistance control								
RINV	Sets the unit to external resistance (inverted) control								
Return parameter	Returns mode of the external control, by the "Control:{OFF Volt Res Rinverse}" string.								
Example	:EXT OFF Turns external control off.								

Query example :EXT?
 >Control:OFF
 External control is setting is off.

Set →

→ Query

4-8-2. [:CONFigure]:EXTErnal:LOAdonin

Description	Query and settings for the external switch. External switch(LoadOn IN) is whether or not turned on the load setting of at the time of the open(HIGH) or closed(LOW).
Syntax	[:CONFigure]:EXTErnal:LOAdonin {OFF High Low}
Query Syntax	[:CONFigure]:EXTErnal:LOAdonin?
Parameter	OFF LoadOn IN = off HIGH LoadOn IN = open LOW LoadOn IN = closed
Return Parameter	Returns the setting value of external switch, by the "LoadOn In:{OFF High Low}" string.
Example	:EXT:LOA OFF Turns The LoadOn off.
Query example	: EXT:LOA? >LoadOn In:OFF The LoadOn In setting is off.
Related Commands	[:CONFigure]:EXTErnal:SYNC

Set →

→ Query

4-8-3. [:CONFigure]:EXTErnal:SYNC

Description	Query and settings for the synchronous mode of external trigger.
Syntax	[:CONFigure]:EXTErnal:SYNC {OFF ON }
Query Syntax	[:CONFigure]:EXTErnal:SYNC?
Parameter	OFF Turns external sync off. ON Turns external sync on.
Example	:EXT:SYNC OFF Turns Sync-mode off.
Query example	:EXT:SYNC? >OFF Sync-mode I is off.
Related Commands	[:CONFigure]:EXTErnal:LOAdonin

4-9.Mode Subsystem Commands

Set →
 → Query

4-9-1. :MODE

Description	Query and settings for the operating mode.	
Syntax	:MODE {CC CR CV CP CCCV CRCV CPCV}	
Query Syntax	:MODE?	
Parameter	CC	CC mode
	CR	CR mode
	CV	CV mode
	CP	CP mode
	CCCV	CC + CV mode
	CRCV	CR + CV mode
	CPCV	CP + CV mode
Example	:MODE CC Sets the mode to CC mode.	
Query example	:MODE? >CC Returns the operating mode (CC mode).	

Set →
 → Query

4-9-2. [:MODE]:CRANge

Description	Query and settings for the current range of all the operating mode.	
Syntax	[:MODE]:CRANge {HIGH MIDDLE LOW}	
Query Syntax	[:MODE]:CRANge?	
Parameter	HIGH	High range
	MIDDLE	Middle range
	LOW	Low range
Return parameter	Returns the setting of Setting of the current range, by the "{High Mid Low}" string.	
Example	:CRAN LOW Sets the current range to Low.	
Query example	:CRAN? >Low The current range is set to Low.	

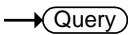
 →
 → 

4-9-3. [:MODE]:VRANge

Description	Query and settings for the voltage range of all the operating mode.
Syntax	[:MODE]:VRANge { HIGH LOW }
Query Syntax	[:MODE]:VRANge?
Parameter	HIGH High range LOW Low range
Return parameter	Returns the setting of Setting of the voltage range, by the "{High Low}" string.
Example	:VRAN LOW Sets the voltage range to Low.
Query example	:VRAN? >Low The voltage range is set to Low.

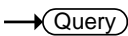
 →
 → 

4-9-4. [:MODE]:RESPonse

Description	Query and settings for The response speed of the CV mode. The default is fast response.
Syntax	[:MODE]:RESPonse { FAST SLOW }
Query Syntax	[:MODE]:RESPonse?
Parameter	FAST Fast response SLOW Slow response
Example	:RESP FAST Sets the CV response to fast.
Query example	:RESP? >FAST The speed response of CV mode is set to fast.

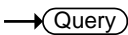
 →
 → 

4-9-5. [:MODE]:DYNAmic

Description	Query and settings for the Switching mode.
Syntax	[:MODE]:DYNAmic { DYNAmic STATic }
Query Syntax	[:MODE]:DYNAmic?
Parameter	DYNAmic Set to Dynamic mode STATic Set to Static mode
Return parameter	Returns the Setting of Switching mode, by the "{Dynamic Static}" string.

Example	:DYN DYN Set the switching mode to dynamic
Query example	:DYN? >Dynamic The switching mode is set to dynamic mode.

4-10.Current Subsystem Commands

Set →

4-10-1. :CURRent[:VA]

→ Query

Description	Query and settings for the "A Value" current of the CC mode. This command is applicable to static mode only. Note: A different current value can be set for each current range (High/Mid/Low). Note: The [:VA] node can only be omitted when in static mode.
Syntax	:CURRent[:VA] {<NRf>[A] MINimum MAXimum }
Query Syntax	:CURRent[:VA]?
Parameter	<NRf>[A] "A Value" current value MINimum Minimum current level MAXimum Maximum current level
Return parameter	Return the current value of "A Value", by the "<NR2>" string.
Example	:CURR MIN Sets the current value to the minimum.
Query example	:CURR? >1.0 Current setting of "A Value" is set to 1A.

4-10-2. :CURRent[:VA]:TRIGgered

Set →

Description	Set the current value when the trigger is activated.
Syntax	:CURRent[:VA]:TRIGgered {<NR2>[A] MINimum MAXimum }
Parameter	<NRf>[A] "A Value" current value MINimum Minimum current level MAXimum Maximum current level
Example	:CURR:TRIG MIN Set the minimum current value when the trigger is activated.

Related Commands *TRG, :INITiate:CONTinuous, :INITiate[:IMMediate]

Set →

4-10-3. :CURRent:VB

→ Query

Description Query and settings for the "B Value" current of the CC mode. This command is applicable to static mode only. Note: A different current value can be set for each current range (High/Mid/Low).

Syntax :CURRent:VB {<NRf>[A] | MINimum | MAXimum }

Query Syntax :CURRent:VB?

Parameter	<NRf>[A]	"B Value" current value
	MINimum	Minimum current level
	MAXimum	Maximum current level

Return parameter Return the Current value of "B Value", by the "<NR2>" string.

Example :CURR:VB MIN
Sets the current value to the minimum.

Query example :CURR:VB?
>1.0
Current setting of "B Value" is set to 1A.

Set →

4-10-4. :CURRent:SRATe

→ Query

Description Query and settings for the current slew rate of CC static mode.

Syntax :CURRent:SRATe {<NRf> | MINimum | MAXimum }

Query Syntax :CURRent:SRATe?

Parameter	<NRf>	Sets the slew rate in mA/uS
	MINimum	Set to the lowest slew rate
	MAXimum	Set to the highest slew rate

Return parameter Return the slew rate, by the "<NR2>" string.

Example :CURR:SRAT MIN
Sets the slew rate to the minimum.

Query example :CURR:SRAT?
>5.0
The slew rate is set to 5.0mA/uS.

Set →
 → Query

4-10-5. :CURRENT:L1

Description	<p>Query and settings for the “Level1” current of the CC mode. This command applies in dynamic value mode only.</p> <p>Note: A different current value can be set for each range (High/Mid/Low).</p>						
Syntax	:CURRENT:L1 {<NRf>[A] MINimum MAXimum }						
Query Syntax	:CURRENT:L1?						
Parameter	<table border="0"> <tr> <td style="padding-right: 20px;"><NRf>[A]</td> <td>“Level1” current value</td> </tr> <tr> <td>MINimum</td> <td>Minimum current level</td> </tr> <tr> <td>MAXimum</td> <td>Maximum current level</td> </tr> </table>	<NRf>[A]	“Level1” current value	MINimum	Minimum current level	MAXimum	Maximum current level
<NRf>[A]	“Level1” current value						
MINimum	Minimum current level						
MAXimum	Maximum current level						
Return parameter	Return the current value of "Level1", by the "<NR2>" string.						
Example	:CURR:L1 MIN Sets the current value to the minimum.						
Query example	:CURR:L1? >1.0 Current setting of " Level1" is set to 1A.						

Set →
 → Query

4-10-6. :CURRENT:L2

Description	<p>Query and settings for the “Level2” current of the CC mode. This command applies in dynamic value mode only.</p> <p>Note: A different current value can be set for each range (High/Mid/Low).</p>						
Syntax	:CURRENT:L2 {<NRf>[A] MINimum MAXimum }						
Query Syntax	:CURRENT:L2?						
Parameter	<table border="0"> <tr> <td style="padding-right: 20px;"><NRf>[A]</td> <td>“Level2” current value</td> </tr> <tr> <td>MINimum</td> <td>Minimum current level</td> </tr> <tr> <td>MAXimum</td> <td>Maximum current level</td> </tr> </table>	<NRf>[A]	“Level2” current value	MINimum	Minimum current level	MAXimum	Maximum current level
<NRf>[A]	“Level2” current value						
MINimum	Minimum current level						
MAXimum	Maximum current level						
Return parameter	Return the current value of "Level2", by the "<NR2>" string.						
Example	:CURR:L2 MIN Sets the current value to the minimum.						
Query example	:CURR:L2? >1.0 Current setting of " Level2" is set to 1A.						

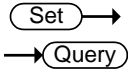

4-10-7. :CURRent:SET

Description	Query and settings for the current when CC dynamic mode is set to %. This command applies in dynamic Percent mode only.	
Syntax	:CURRent:SET{<NRf>[A] MINimum MAXimum }	
Query Syntax	:CURRent:SET?	
Parameter	<NRf>[A]	The current value at the time of "Level=100%"
	MINimum	Minimum current value
	MAXimum	Maximum current value
Return parameter	Return the current value of "Level = 100%", by the "<NR2>" string.	
Example	:CURR:SET MIN Sets the minimum current value of "Level = 100%".	
Query example	:CURR:SET? >1.0 Current value of "Level = 100%" is set to 1A.	
Related Commands	:CURRent:LEVel	

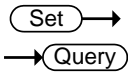

4-10-8. :CURRent:LEVel

Description	Query and settings for the % Level(Percentage of the set current value) when CC dynamic mode is set to %. This command applies in dynamic Percent mode only.	
Syntax	:CURRent:LEVel {<NRf> MINimum MAXimum }	
Query Syntax	:CURRent:LEVel?	
Parameter	<NRf>	% of "SET" current level (unit is %)
	MINimum	Minimum % of "SET" current level
	MAXimum	Maximum % of "SET" current level
Return parameter	Return the current of "% Level", by the "<NR2>" string.	
Example	:CURR:LEV MIN Sets the % level current value to the minimum.	
Query example	:CURR:LEV? >50 Percentage of the set current value is set to 50%.	
Related Commands	:CURRent:SET	

Set →
 → Query

4-10-9. :CURRent:RISE

Description	Query and settings for the rise of the current slew rate of the CC dynamic mode.	
Syntax	:CURRent:RISE {<NRf> MINimum MAXimum }	
Query Syntax	:CURRent:RISE?	
Parameter	<NRf>	Rising current slew rate (unit is mA/uS)
	MINimum	Minimum slew rate
	MAXimum	Maximum slew rate
Return parameter	Return the rise of the current slew rate, by the "<NR2>" string.	
Example	:CURR:RISE MIN Sets the rising slew rate to the minimum.	
Query example	:CURR:RISE? >5000 Returns the rising slew rate as 5000mA/uS.	
Related Commands	:CURRent:FALL	

Set →
 → Query

4-10-10. :CURRent:FALL

Description	Query and settings for the falling of the current slew rate of the CC dynamic mode.	
Syntax	:CURRent:FALL {<NRf> MINimum MAXimum }	
Query Syntax	:CURRent:FALL?	
Parameter	<NRf>	Falling current slew rate (unit is mA/uS)
	MINimum	Minimum slew rate
	MAXimum	Maximum slew rate
Return parameter	Return the falling of the current slew rate, by the "<NR2>" string.	
Example	:CURR:FALL MIN Sets the falling slew rate to the minimum.	
Query example	:CURR:FALL? >5000 Returns the falling slew rate as 5000mA/uS.	
Related Commands	:CURRent:RISE	

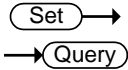

4-10-11. :CURRent:T1

Description	Query and settings for the timer T1 of CC dynamic mode. This command applies in dynamic timer mode.	
Syntax	:CURRent:T1 {<NRf>[S] MINimum MAXimum }	
Query Syntax	:CURRent:T1?	
Parameter	<NRf>[S] MINimum MAXimum	T1 timer setting. (unit is seconds) Minimum time Maximum time
Return parameter	Return the setting of the timer T1, by the "<NR2>" string.	
Example	:CURR:T1 0.2 Sets the setting of the timer T1.	
Query example	:CURR:T1? >0.2 Return the setting of the timer T1.	
Related Commands	:CURRent:T2	

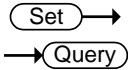

4-10-12. :CURRent:T2

Description	Query and settings for the timer T2 of CC dynamic mode. This command applies in dynamic timer mode.	
Syntax	:CURRent:T2 {<NRf>[S] MINimum MAXimum }	
Query Syntax	:CURRent:T2?	
Parameter	<NRf>[S] MINimum MAXimum	T2 timer setting. (unit is seconds) Minimum time Maximum time
Return parameter	Return the setting of the timer T2, by the "<NR2>" string.	
Example	:CURR:T2 0.2 Sets the setting of the timer T2.	
Query example	:CURR:T2? >0.2 Returns the setting of the timer T2.	
Related Commands	:CURRent:T1	

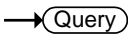
4-10-13. :CURRent:FREQUENCY

Description	Query and settings for switching frequency value of the CC dynamic mode. This command applies in dynamic duty cycle mode.	
Syntax	:CURRent:FREQUENCY {<NRf> MINimum MAXimum }	
Query Syntax	:CURRent:FREQUENCY?	
Parameter	<NRf>	Sets the switching frequency.(unit is Hz)
	MINimum	Minimum frequency
	MAXimum	Maximum frequency
Return parameter	Return the switching frequency, by the "<NR2>" string.	
Example	:CURR:FREQ 60 Sets frequency to 60Hz.	
Query example	:CURR:FREQ? >60 Returns the switching frequency as 60Hz.	
Related Commands	:CURRent:Duty	

4-10-14. :CURRent:DUTY

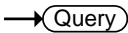
Description	Query and settings for the duty cycle positive for the switching frequency of the CC dynamic mode. This command applies in dynamic duty cycle mode.	
Syntax	:CURRent:DUTY {<NRf> MINimum MAXimum }	
Query Syntax	:CURRent:DUTY?	
Parameter	<NRf>	Sets the duty cycle as a percentage.
	MINimum	Minimum duty cycle
	MAXimum	Maximum duty cycle
Return parameter	Return the duty cycle of positive, by the "<NR2>" string.	
Example	:CURR:DUTY 50 Sets the duty cycle 50%.	
Query example	:CURR:DUTY? >50 Returns the duty cycle as 50%.	
Related Commands	:CURRent:FREQUENCY	

4-10-15. :CURRent:RECall

Description	Sets or queries whether A Value or B Value is the currently active value in CC static mode.	
Syntax	: CURRent:RECall {A 0 B 1}	
Query Syntax	: CURRent:RECall?	
Parameter	A 0	Select A value
	B 1	Select B value
Return parameter	0	Selected A Value
	1	Selected B Value
Example	:CURR:REC 1 Selected B Value	
Query example	:CURR:REC? >0 Selected A Value	

4-11. Resistance Subsystem Commands

4-11-1. :RESistance[:VA]

Description	Query and settings for the "A Value" resistance of the CR mode. This command is applicable to static modes. Note: A different value can be set for each current range (High/Mid/Low). Note: The optional command node [:VA] can only be omitted when in static mode.	
Syntax	:RESistance[:VA] {<NRf>[ohm] MINimum MAXimum }	
Query Syntax	:RESistance[:VA]?	
Parameter	<NRf>[ohm]	"A Value" resistance value
	MINimum	Minimum resistance level
	MAXimum	Maximum resistance level
Return parameter	Return the resistance value of "A Value", by the "<NR2>" string.	
Example	:RES:VA MIN Sets the resistance value to the minimum.	
Query example	:RES:VA? >9.840 Return the resistance value of "A Value".	

4-11-2. :RESistance[:VA]:TRIGgered

Set →

Description	Set the resistance value when the trigger is activated.	
Syntax	:RESistance[:VA]:TRIGgered {<NRf>[ohm] MINimum MAXimum }	
Parameter	<NRf>[ohm] MINimum MAXimum	"A Value" resistance value Minimum resistance level Maximum resistance level
Example	:RES:TRIG MIN Set the minimum resistance value when the trigger is activated.	
Related Commands	*TRG, :INITiate:CONTinuous, :INITiate[:IMMEDIATE]	

4-11-3. :RESistance:VB

Set →
→ Query

Description	Query and settings for the "B Value" resistance of the CR mode. This command is applicable to static modes. Note: A different value can be set for each current range (High/Mid/Low).	
Syntax	:RESistance:VB {<NRf>[ohm] MINimum MAXimum }	
Query Syntax	:RESistance:VB?	
Parameter	<NRf>[ohm] MINimum MAXimum	"B Value" resistance value Minimum resistance level Maximum resistance level
Return parameter	Return the resistance value of "B Value", by the "<NR2>" string.	
Example	:RES:VB MIN Sets the resistance value to the minimum.	
Query example	:RES:VB? >9.840 Return the resistance value of "B Value".	

Set →
→ Query

4-11-4. :RESistance:SRATe

Description	Query and settings for the conductance slew rate of CR static mode.	
Syntax	:RESistance:SRATe {<NRf> MINimum MAXimum }	
Query Syntax	:RESistance:SRATe?	

Parameter	<NRf> MINimum MAXimum	Sets the conductance slew rate in mA/uS Set to the lowest slew rate Set to the highest slew rate
Return parameter	Return the conductance slew rate, by the "<NR2>" string.	
Example	:RES:SRAT MIN Sets the slew rate to the minimum.	
Query example	:RES:SRAT? >5.0000 Return the conductance slew rate.	

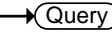
 →
 → 

4-11-5. :RESistance:L1

Description	Query and settings for the "Level1" resistance of the CR mode. This command applies in dynamic value mode. Note: A different value can be set for each current range (High/Mid/Low).	
Syntax	:RESistance:L1 {<NRf>[ohm] MINimum MAXimum }	
Query Syntax	:RESistance:L1?	
Parameter	<NRf>[ohm] MINimum MAXimum	"level1" resistance value Minimum resistance level Maximum resistance level
Return parameter	Return the resistance value of "Level1", by the "<NR2>" string.	
Example	:RES:L1 MIN Sets the resistance value to the minimum.	
Query example	:RES:L1? >9.840 Return the resistance value of "Level1".	

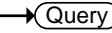
 →
 → 

4-11-6. :RESistance:L2

Description	Query and settings for the "Level2" resistance of the CR mode. This command applies in dynamic value mode. Note: A different value can be set for each current range (High/Mid/Low).	
Syntax	:RESistance:L2 {<NRf>[ohm] MINimum MAXimum }	
Query Syntax	:RESistance:L2?	
Parameter	<NRf>[ohm] MINimum MAXimum	"level2" resistance value Minimum resistance level Maximum resistance level

Return parameter	Return the resistance value of "Level2", by the "<NR2>" string.
Example	:RES:L2 MIN Sets the resistance value to the minimum.
Query example	:RES:L2? >9.840 Return the resistance value of "Level2".

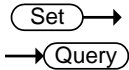

4-11-7. :RESistance:SET

Description	Query and settings for the resistance when CC dynamic mode is set to %. This command applies in dynamic Percent mode.
Syntax	:RESistance:SET {<NRf>[ohm] MINimum MAXimum }
Query Syntax	:RESistance:SET?
Parameter	<NRf>[ohm] "The resistance value at the time of "Level=100%" MINimum Minimum resistance value MAXimum Maximum resistance value
Return parameter	Return the resistance value of "Level = 100%", by the "<NR2>" string.
Example	:RES:SET MIN Sets the minimum resistance value of "Level = 100%".
Query example	:RES:SET? >9.840 Return the resistance value of "Level = 100%".

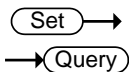

4-11-8. :RESistance:LEVel

Description	Sets or queries the CR mode % level (percentage of the Set conductance value) when the dynamic mode units are set to Percent. This command applies in dynamic Percent mode.
Syntax	:RESistance:LEVel {<NRf> MINimum MAXimum }
Query Syntax	:RESistance:LEVel?
Parameter	<NRf> % of "SET" Millisiemens level (unit is %) MINimum Minimum % of "SET" conductance level MAXimum Maximum % of "SET" conductance level

Return parameter	Return the Millisiemens of "% Level", by the "<NR2>" string.
Example	:RES:LEV MIN Sets the % level Millisiemens value to the minimum.
Query example	:RES:LEV? >50 Return the Millisiemens of "% Level".
Related Commands	:RESistance:SET

Set →

→ Query

4-11-9. :RESistance:RISE

Description	Query and settings for the rise of the conductance slew rate of the CR dynamic mode.						
Syntax	:RESistance:RISE {<NRf> MINimum MAXimum }						
Query Syntax	:RESistance:RISE?						
Parameter	<table border="1"> <tr> <td><NRf></td> <td>Rising conductance slew rate (unit is mA/uS)</td> </tr> <tr> <td>MINimum</td> <td>Minimum slew rate</td> </tr> <tr> <td>MAXimum</td> <td>Maximum slew rate</td> </tr> </table>	<NRf>	Rising conductance slew rate (unit is mA/uS)	MINimum	Minimum slew rate	MAXimum	Maximum slew rate
<NRf>	Rising conductance slew rate (unit is mA/uS)						
MINimum	Minimum slew rate						
MAXimum	Maximum slew rate						
Return parameter	Return the rise of the conductance slew rate, by the "<NR2>" string.						
Example	:RES:RISE MIN Sets the rising slew rate to the minimum.						
Query example	:RES:RISE? >50.000 Return the rise of the conductance slew rate.						
Related Commands	:RESistance:FALL						

Set →

→ Query

4-11-10. :RESistance:FALL

Description	Query and settings for the falling of the conductance slew rate of the CR dynamic mode.						
Syntax	:RESistance:FALL {<NRf> MINimum MAXimum }						
Query Syntax	:RESistance:FALL?						
Parameter	<table border="1"> <tr> <td><NRf></td> <td>Falling conductance slew rate (unit is mA/uS)</td> </tr> <tr> <td>MINimum</td> <td>Minimum slew rate</td> </tr> <tr> <td>MAXimum</td> <td>Maximum slew rate</td> </tr> </table>	<NRf>	Falling conductance slew rate (unit is mA/uS)	MINimum	Minimum slew rate	MAXimum	Maximum slew rate
<NRf>	Falling conductance slew rate (unit is mA/uS)						
MINimum	Minimum slew rate						
MAXimum	Maximum slew rate						
Return parameter	Return the falling of the conductance slew rate, by the "<NR2>" string.						

Example	:RES:FALL MIN Sets the falling slew rate to the minimum.
Query example	:RES:FALL? >50.000 Return the falling of the conductance slew rate.
Related Commands	:RESistance:RISE

Set →

→ Query

4-11-11. :RESistance:T1

Description	Query and settings for the timer T1 of CR dynamic mode. This command applies in dynamic timer mode.						
Syntax	:RESistance:T1 {<NRf>[S] MINimum MAXimum }						
Query Syntax	:RESistance:T1?						
Parameter	<table border="1"> <tr> <td><NRf>[S]</td> <td>T1 timer setting. (unit is seconds)</td> </tr> <tr> <td>MINimum</td> <td>Minimum time</td> </tr> <tr> <td>MAXimum</td> <td>Maximum time</td> </tr> </table>	<NRf>[S]	T1 timer setting. (unit is seconds)	MINimum	Minimum time	MAXimum	Maximum time
<NRf>[S]	T1 timer setting. (unit is seconds)						
MINimum	Minimum time						
MAXimum	Maximum time						
Return parameter	Return the setting of the timer T1, by the "<NR2>" string.						
Example	:RES:T1 0.2 Sets the setting of the timer T1.						
Query example	: RES:T1? >0.2 Return the setting of the timer T1.						
Related Commands	:RESistance:T2						

Set →

→ Query

4-11-12. :RESistance:T2

Description	Query and settings for the timer T2 of CR dynamic mode. This command applies in dynamic timer mode.						
Syntax	:RESistance:T2 {<NRf>[S] MINimum MAXimum }						
Query Syntax	:RESistance:T2?						
Parameter	<table border="1"> <tr> <td><NRf>[S]</td> <td>T2 timer setting. (unit is seconds)</td> </tr> <tr> <td>MINimum</td> <td>Minimum time</td> </tr> <tr> <td>MAXimum</td> <td>Maximum time</td> </tr> </table>	<NRf>[S]	T2 timer setting. (unit is seconds)	MINimum	Minimum time	MAXimum	Maximum time
<NRf>[S]	T2 timer setting. (unit is seconds)						
MINimum	Minimum time						
MAXimum	Maximum time						
Return parameter	Return the setting of the timer T2, by the "<NR2>" string.						
Example	:RES:T2 0.2 Sets the setting of the timer T2.						

Query example :RES:T2?
>0.2
Return the setting of the timer T2.

Related Commands :RESistance:T1

Set →

4-11-13. :RESistance:FREQUENCY

→ Query

Description Query and settings for switching frequency value of the CR dynamic mode. This command applies in dynamic duty cycle mode.

Syntax :RESistance:FREQUENCY {<NRf> | MINimum | MAXimum }

Query Syntax :RESistance:FREQUENCY?

Parameter	<NRf>	Sets the switching frequency. (unit is hertz)
	MINimum	Minimum frequency
	MAXimum	Maximum frequency

Return parameter Return the switching frequency, by the "<NR2>" string.

Example :RES:FREQ 60
Sets frequency to 60Hz.

Query example :RES:FREQ?
>60
Returns the switching frequency as 60Hz.

Related Commands :RESistance:DUTY

Set →

4-11-14. :RESistance:DUTY

→ Query

Description Query and settings for the duty cycle positive for the switching frequency of the CR dynamic mode. This command applies in dynamic duty cycle mode.

Syntax :RESistance:DUTY {<NRf> | MINimum | MAXimum }

Query Syntax :RESistance:DUTY?

Parameter	<NRf>	Sets the duty as a percentage.
	MINimum	Minimum duty
	MAXimum	Maximum duty

Return parameter Return the duty cycle of positive, by the "<NR2>" string.

Example :RES:DUTY 50
Sets the duty cycle 50%.

Query example :RES:DUTY?
>50
Returns the duty cycle as 50%.

Related Commands :RESistance:FREQuency

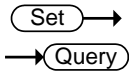

4-11-15. :CONDuctance[:VA]

Description Query and settings for the "A Value" CONDuctance of the CR mode. This command is applicable to static modes.
Note: A different value can be set for each current range (High/Mid/Low).
Note: The optional command node [:VA] can only be omitted when in static mode.

Syntax :CONDuctance [:VA] {<NRf>[mho] | MINimum | MAXimum }

Query Syntax :RESistance[:VA]?

Parameter	<NRf>[mho]	"A Value" Millisiemens value
	MINimum	Minimum conductance level
	MAXimum	Maximum conductance level

Return parameter Return the Millisiemens value of "A Value", by the "<NR2>" string.

Example :COND:VA MIN
Sets the Millisiemens value to the minimum.

Query example :COND:VA?
>9.840
Return the Millisiemens value of "A Value".

4-11-16. :CONDuctance [:VA]:TRIGgered 

Description Set the Conductance value when the trigger is activated.

Syntax :CONDuctance [:VA]:TRIGgered {<NRf>[mho] | MINimum | MAXimum }

Parameter	<NRf>[mho]	"A Value" Millisiemens value
	MINimum	Minimum conductance level
	MAXimum	Maximum conductance level

Example :COND:TRIG MIN
Set the minimum millisiemens value when the trigger is activated.

Related Commands *TRG, :INITiate:CONTinuous, :INITiate[:IMMediate]

Set →
 → Query

4-11-17. :CONDuctance:VB

Description	Query and settings for the "B Value" conductance of the CR mode. This command is applicable to static modes. Note: A different value can be set for each current range (High/Mid/Low).						
Syntax	:CONDuctance:VB {<NRf>[mho] MINimum MAXimum }						
Query Syntax	:CONDuctance:VB?						
Parameter	<table border="0" style="width: 100%;"> <tr> <td style="width: 30%;"><NRf>[mho]</td> <td>"B Value" Millisiemens value</td> </tr> <tr> <td>MINimum</td> <td>Minimum conductance level</td> </tr> <tr> <td>MAXimum</td> <td>Maximum conductance level</td> </tr> </table>	<NRf>[mho]	"B Value" Millisiemens value	MINimum	Minimum conductance level	MAXimum	Maximum conductance level
<NRf>[mho]	"B Value" Millisiemens value						
MINimum	Minimum conductance level						
MAXimum	Maximum conductance level						
Return parameter	Return the Millisiemens value of "B Value", by the "<NR2>" string.						
Example	:COND:VB MIN Sets the Millisiemens value to the minimum.						
Query example	:COND:VB? >9.840 Return the Millisiemens value of "B Value".						

Set →
 → Query

4-11-18. :CONDuctance:L1

Description	Query and settings for the "Level1" conductance of the CR mode. This command applies in dynamic value mode. Note: A different value can be set for each current range (High/Mid/Low).						
Syntax	:CONDuctance:L1 {<NRf>[mho] MINimum MAXimum }						
Query Syntax	:CONDuctance:L1?						
Parameter	<table border="0" style="width: 100%;"> <tr> <td style="width: 30%;"><NRf>[mho]</td> <td>"level1" Millisiemens value</td> </tr> <tr> <td>MINimum</td> <td>Minimum conductance level</td> </tr> <tr> <td>MAXimum</td> <td>Maximum conductance level</td> </tr> </table>	<NRf>[mho]	"level1" Millisiemens value	MINimum	Minimum conductance level	MAXimum	Maximum conductance level
<NRf>[mho]	"level1" Millisiemens value						
MINimum	Minimum conductance level						
MAXimum	Maximum conductance level						
Return parameter	Return the Millisiemens value of "Level1", by the "<NR2>" string.						
Example	:COND:L1 MIN Sets the Millisiemens value to the minimum.						
Query example	:COND:L1? >9.840 Return the Millisiemens value of "Level1".						

Set →
 → Query

4-11-19. :CONDuctance:L2

Description	Query and settings for the "Level2" conductance of the CR mode. This command applies in dynamic value mode. Note: A different value can be set for each current range (High/Mid/Low).						
Syntax	:CONDuctance:L2 {<NRf>[mho] MINimum MAXimum }						
Query Syntax	:CONDuctance:L2?						
Parameter	<table border="0"> <tr> <td style="padding-right: 20px;"><NRf>[mho]</td> <td>"level2" Millisiemens value</td> </tr> <tr> <td>MINimum</td> <td>Minimum conductance level</td> </tr> <tr> <td>MAXimum</td> <td>Maximum conductance level</td> </tr> </table>	<NRf>[mho]	"level2" Millisiemens value	MINimum	Minimum conductance level	MAXimum	Maximum conductance level
<NRf>[mho]	"level2" Millisiemens value						
MINimum	Minimum conductance level						
MAXimum	Maximum conductance level						
Return parameter	Return the Millisiemens value of "Level2", by the "<NR2>" string.						
Example	:COND:L2 MIN Sets the Millisiemens value to the minimum.						
Query example	:COND:L2? >9.840 Return the Millisiemens value of "Level2".						

Set →
 → Query

4-11-20. :CONDuctance:SET

Description	Query and settings for the conductance when CC dynamic mode is set to %. This command applies in dynamic Percent mode.						
Syntax	:CONDuctance:SET {<NRf>[mho] MINimum MAXimum }						
Query Syntax	:CONDuctance:SET?						
Parameter	<table border="0"> <tr> <td style="padding-right: 20px;"><NRf>[mho]</td> <td>"The Millisiemens value at the time of "Level=100%"</td> </tr> <tr> <td>MINimum</td> <td>Minimum Millisiemens value</td> </tr> <tr> <td>MAXimum</td> <td>Maximum Millisiemens value</td> </tr> </table>	<NRf>[mho]	"The Millisiemens value at the time of "Level=100%"	MINimum	Minimum Millisiemens value	MAXimum	Maximum Millisiemens value
<NRf>[mho]	"The Millisiemens value at the time of "Level=100%"						
MINimum	Minimum Millisiemens value						
MAXimum	Maximum Millisiemens value						
Return parameter	Return the Millisiemens value of "Level = 100%", by the "<NR2>" string.						
Example	:COND:SET MIN Sets the minimum Millisiemens value of "Level = 100%".						
Query example	:COND:SET? >9.840 Return the Millisiemens value of "Level = 100%".						

4-11-21. :CONDuctance:RECall

Description	Sets or queries whether A Value or B Value is the currently active value in CR static mode when the units are set to Siemens.	
Syntax	: CONDuctance:RECall {A 0 B 1}	
Query Syntax	: CONDuctance:RECall?	
Parameter	A 0	Select A value
	B 1	Select B value
Return parameter	0	Selected A Value
	1	Selected B Value
Example	:COND:REC 1 Selected B Value	
Query example	:COND:REC? >0 Selected A Value	

4-11-22. :RESistance:RECall

Description	Sets or queries whether A Value or B Value is the currently active value in CR static mode.	
Syntax	: RESistance:RECall {A 0 B 1}	
Query Syntax	: RESistance:RECall?	
Parameter	A 0	Select A value
	B 1	Select B value
Return parameter	0	Selected A Value
	1	Selected B value
Example	:RESI:REC 1 Selected B Value	
Query example	:RESI:REC? >0 Selected A Value	

4-12. Voltage Subsystem Commands

4-12-1. :VOLTage[:VA]

Description	Sets or queries the CV mode “A Value” voltage or the +CV voltage value. Note: The same value applies for each current range (High/Mid/Low).
-------------	---

Note: The optional command node [:VA] can only be omitted when in static mode.

Syntax	:VOLTage[:VA] {<NRf>[V] MINimum MAXimum }	
Query Syntax	:VOLTage[:VA]?	
Parameter	<NRf>[V]	"A Value" voltage value
	MINimum	Minimum voltage level
	MAXimum	Maximum voltage level
Return parameter	Return the voltage value of "A Value", by the "<NR2>" string.	
Example	:VOLT:VA MIN Sets the voltage value to the minimum.	
Query example	:VOLT:VA? >1.00 Voltage setting of " A Value " is set to 1V.	

Set →

→ Query

4-12-2. :VOLTage:VB

Description	Sets or queries the CV mode "B Value". Note: The same value applies for each current range (High/Mid/Low).	
Syntax	:VOLTage:VB {<NRf>[V] MINimum MAXimum }	
Query Syntax	:VOLTage:VB?	
Parameter	<NRf>[V]	"B Value" voltage value
	MINimum	Minimum voltage level
	MAXimum	Maximum voltage level
Return parameter	Return the voltage value of "B Value", by the "<NR2>" string.	
Example	:VOLT:VB MIN Sets the voltage value to the minimum.	
Query example	:VOLT:VB? >1.00 Voltage setting of " B Value " is set to 1V.	

Set →

→ Query

4-12-3. :VOLTage:RECall

Description	Sets or queries whether A Value or B Value is the currently active value in CV mode.	
Syntax	: VOLTage:RECall {A 0 B 1}	
Query Syntax	: VOLTage:RECall?	
Parameter	A 0	Select A value
	B 1	Select B value

Return parameter	0 1	Selected A Value Selected B Value
Example	:VOLT:REC 1 Selected B Value	
Query example	:VOLT:REC? >0 Selected A Value	

4-13. Power Subsystem Commands

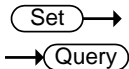

4-13-1. :POWER[:VA]

Description	Query and settings for the “A Value” power of the CP mode. This command is applicable to static mode only. Note: A different current value can be set for each current range (High/Mid/Low). Note: The [:VA] node can only be omitted when in static mode.	
Syntax	:POWER[:VA] {<NRf>[W] MINimum MAXimum }	
Query Syntax	:POWER[:VA]?	
Parameter	<NRf>[W] MINimum MAXimum	“A Value” power value Minimum power level Maximum power level
Return parameter	Return the power value of "A Value", by the "<NR2>" string.	
Example	:POW:VA MIN Sets the power value to the minimum.	
Query example	:POW:VA? >10 Power setting of "A Value" is set to 10W.	

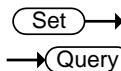

4-13-2. :POWER:VB

Description	Query and settings for the “B Value” power of the CP mode. This command is applicable to static mode only. Note: A different current value can be set for each current range (High/Mid/Low).	
Syntax	:POWER:VB {<NRf>[W] MINimum MAXimum }	
Query Syntax	:POWER:VB?	
Parameter	<NRf>[W] MINimum	“B Value” power value Minimum power level

	MAXimum Maximum power level
Return parameter	Return the power value of "B Value", by the "<NR2>" string.
Example	:POW:VB MIN Sets the power value to the minimum.
Query example	:POW:VB? >10 Power setting of "B Value" is set to 10W.

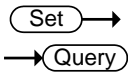

4-13-3. :POWER:L1

Description	Query and settings for the "Level1" power of the CP mode. This command applies in dynamic value mode only. Note: A different "Level1" value can be set for different current ranges.
Syntax	:POWER:L1 {<NRf>[W] MINimum MAXimum }
Query Syntax	:POWER:L1?
Parameter	<NRf>[W] "Level1" power value MINimum Minimum power level MAXimum Maximum power level
Return parameter	Return the power value of "Level1", by the "<NR2>" string.
Example	:POW:L1 MIN Sets the power value to the minimum.
Query example	:POW:L1? >10 Power setting of "Level1" is set to 10W.

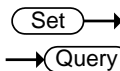

4-13-4. :POWER:L2

Description	Query and settings for the "Level2" power of the CP mode. This command applies in dynamic value mode only. Note: A different "Level2" value can be set to different current ranges.
Syntax	:POWER:L2 {<NRf>[W] MINimum MAXimum }
Query Syntax	:POWER:L2?
Parameter	<NRf>[W] "Level2" power value MINimum Minimum power level MAXimum Maximum power level

Return parameter	Return the power value of "Level2", by the "<NR2>" string.
Example	:POW:L2 MIN Sets the power value to the minimum.
Query example	:POW:L2? >10 Power setting of "Level2" is set to 10W.

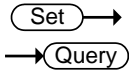

4-13-5. :POWER:SET

Description	Query and settings for the power when CP dynamic mode is set to %. This command applies in dynamic Percent mode only.
Syntax	:POWER:SET {<NRf>[W] MINimum MAXimum }
Query Syntax	:POWER:SET?
Parameter	<NRf>[W] The power value at the time of "Level=100%" MINimum Minimum power value MAXimum Maximum power value
Return parameter	Return the power value of "Level = 100%", by the "<NR2>" string.
Example	:POW:SET MIN Sets the minimum power value of "Level = 100%".
Query example	:POW:SET? >10 power value of "Level = 100%" is set to 10W.
Related Commands	:POWER:LEVel

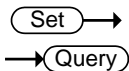

4-13-6. :POWER:LEVel

Description	Query and settings for the % Level(Percentage of the set power value) when CP dynamic mode is set to %. This command applies in dynamic Percent mode only.
Syntax	:POWER:LEVel {<NRf> MINimum MAXimum }
Query Syntax	:POWER:LEVel?
Parameter	<NRf> % of "SET" power level (unit is %) MINimum Minimum % power level MAXimum Maximum % power level
Return parameter	Return the power of "% Level", by the "<NR2>" string.

Example	:POW:LEVel MIN Sets the % level power value to the minimum.
Query example	:POW:LEVel? >50 Percentage of the set power value is set to 50%.
Related Commands	:POWer:Set

Set →

→ Query

4-13-7. :POWer:T1

Description	Query and settings for the timer T1 of CP dynamic mode. This command applies in dynamic timer mode.						
Syntax	:POWer:T1 {<NRf>[S] MINimum MAXimum }						
Query Syntax	:POWer:T1?						
Parameter	<table border="1"> <tr> <td><NRf>[S]</td> <td>T1 timer setting. (unit is seconds)</td> </tr> <tr> <td>MINimum</td> <td>Minimum time</td> </tr> <tr> <td>MAXimum</td> <td>Maximum time</td> </tr> </table>	<NRf>[S]	T1 timer setting. (unit is seconds)	MINimum	Minimum time	MAXimum	Maximum time
<NRf>[S]	T1 timer setting. (unit is seconds)						
MINimum	Minimum time						
MAXimum	Maximum time						
Return parameter	Return the setting of the timer T2, by the "<NR2>" string.						
Example	:POW:T1 0.2 Sets the setting of the timer T1.						
Query example	:POW:T1? >0.2 Return the setting of the timer T1.						
Related Commands	:POWer:T2						

Set →

→ Query

4-13-8. :POWer:T2

Description	Query and settings for the timer T2 of CP dynamic mode. This command applies in dynamic timer mode.						
Syntax	:POWer:T2 {<NRf>[S] MINimum MAXimum }						
Query Syntax	:POWer:T2?						
Parameter	<table border="1"> <tr> <td><NRf>[S]</td> <td>T2 timer setting. (unit is seconds)</td> </tr> <tr> <td>MINimum</td> <td>Minimum time</td> </tr> <tr> <td>MAXimum</td> <td>Maximum time</td> </tr> </table>	<NRf>[S]	T2 timer setting. (unit is seconds)	MINimum	Minimum time	MAXimum	Maximum time
<NRf>[S]	T2 timer setting. (unit is seconds)						
MINimum	Minimum time						
MAXimum	Maximum time						
Return parameter	Return the setting of the timer T2, by the "<NR2>" string.						
Example	:POW:T2 0.2 Sets the setting of the timer T2.						

Query example :POW:T2?
>0.2
Returns the setting of the timer T2.

Related :POWER:T1
Commands

Set →

→ Query

4-13-9. :POWER:FREQUENCY

Description Query and settings for switching frequency value of the CP dynamic mode. This command applies in dynamic duty cycle mode.

Syntax :POWER:FREQUENCY {<NRf> | MINimum | MAXimum }

Query Syntax :POWER: FREQUENCY?

Parameter	<NRf>	Sets the switching frequency. (unit is hertz).
	MINimum	Minimum frequency
	MAXimum	Maximum frequency

Return parameter Return the switching frequency, by the "<NR2>" string.

Example :POW: FREQ 60
Sets the frequency to 60Hz.

Query example :POW: FREQ?
>60
Returns the switching frequency as 60Hz.

Related :POWER: DUTY
Commands

Set →

→ Query

4-13-10. :POWER:DUTY

Description Query and settings for the duty cycle positive for the switching frequency of the CP dynamic mode. This command applies in dynamic duty cycle mode.

Syntax :POWER:DUTY {<NRf> | MINimum | MAXimum }

Query Syntax :POWER:DUTY?

Parameter	<NRf>	Sets the duty cycle as a percentage.
	MINimum	Minimum duty
	MAXimum	Maximum duty

Return parameter Return the duty cycle of positive, by the "<NR2>" string.

Example :POW:DUTY 50
Sets the duty cycle 50%.

Query example :POW:DUTY?
>50
Returns the duty cycle as 50%.

Related :POWER:FREquency
Commands

Set →

→ Query

4-13-11. :POWer:RECall

Description Sets or queries whether A Value or B Value is the currently active value in CP static mode.

Syntax : POWer:RECall {A|0|B|1}

Query Syntax : POWer:RECall?

Parameter	A 0	Select A value
	B 1	Select B value

Return parameter	0	Selected A Value
	1	Selected B Value

Example :POW:REC 1
Selected B Value

Query example :POW:REC?
>0
Selected A Value

4-14.Program Commands

Set →

→ Query

4-14-1. : PROGram

Description Query and setting for all parameters to specified step of the program mode.

Syntax :PROGram (1),(2),(3),(4),(5),(6),(7),(8)

Query Syntax :PROGram?

Parameter	(1) <NR1>	Program number
	(2) <NR1>	Step number
	(3) <NR1>	Internal memory number
	(4) <ASCII string>	Processing settings AUTO: Run processing MANUAL : Wait for the start-up process SKIP : Proceed to the next step
	(5) <NRf>	On-time (unit is seconds)
	(6) <NRf>	Off-time (unit is seconds)



	(7) <NRf>	Delay time of the P/F (unit is seconds)
	(8) <NRf>	Short time (unit is seconds)
Return parameter	(1) <ASCII string> (2) <ASCII string> (3) <ASCII string> (4) <ASCII string> (5) <ASCII string> (6) <ASCII string> (7) <ASCII string> (8) <ASCII string> (9) <ASCII string>	Return the program mode.{ON OFF} Program number Step number Internal memory number Processing is returned by Auto/Manual/Skip. On-time (unit is seconds) Off-time (unit is seconds) Delay time of the P/F (unit is seconds) Short time (unit is seconds)
Example	:PROG 2,3,1,AUTO,40.1,0,0,0 Set all the parameters to specified program step.	
Query example	:PROG ? >Program:OFF; Start:1, Step:1, Memory:1, Run:Skip, On-Time:0.1, Off-Time:0.0, P/F-Time:0.0, Short-Time:0.0 Return the parameters of the program step that is selected after the state of the program mode.	

(Set) →

→ (Query)

4-14-2. [:PROG] :CHAI

Description	Query and settings for all chain of the program chain	
Syntax	[:PROG] :CHAI (1),(2),(3),(4),(5),(6),(7),(8),(9),(10),(11),(12),(13),(14),(15),(16)	
Query Syntax	[:PROG] :CHAI?	
Parameter	(1)~(16) <NR1>	Is a program number to be chain. "OFF" sets off the chain.
Return parameter	<ASCII string>	Return the setting value of all program chain. "Off" is the end of the chain.
Example	:CHA OFF,1,2,3,4,5,6,7,8,9,10,11,12,13,14,15 Program 1 sets off the chain. Program 2-16 sets chain configuration.	
Query example	:CHA? >P1->Off;P2->P1;P3->P2;P4->P3;P5->P4;P6->P5;P7->P6;P8->P7;P9->P8;P10->P9;P11->P10;P12->P11;P13->P12;P14->P13;P15->P14;P16->P15 Return the setting value of all program chain.	

 →
 → 

4-14-3. [:PROGRAM]:CHAI:n:P2P

Description	Query and setting for the chain of the specified program
Syntax	[:PROGRAM]:CHAI:n:P2P (1),(2)
Query Syntax	[:PROGRAM]:CHAI:n:P2P?
Parameter	(1) <NR1> The program number you want to change. (2) {<NR1> OFF} It is a program number to be chain. "OFF" sets off the chain.
Return parameter	<ASCII string> Return the setting value of all program chain. "Off" is the end of the chain.
Example	:CHA:P2P 4,3 Program 4 will chain set in the program 3.
Query example	:CHA:P2P? >P1->Off;P2->P1;P3->P2;P4->P3;P5->P4;P6->P5;P7->P6;P8->P7;P9->P8;P10->P9;P11->P10;P12->P11;P13->P12;P14->P13;P15->P14;P16->P15 Return the setting value of all program chain.

4-14-4. [:PROGRAM]:CHAI:n:RECall]:DEFault

 →

Description	Sets off all the program chain
Syntax	[:PROGRAM]:CHAI:n:RECall]:DEFault
Example	:CHA:DEF Sets off all the program chain.

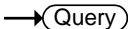
 →
 → 

4-14-5. [:PROGRAM]:CHAI:n:STARt

Description	Query and settings for the start program number of the program chain.
Syntax	[:PROGRAM]:CHAI:n:STARt <NR1>
Query Syntax	[:PROGRAM]:CHAI:n:STARt?
Parameter	<NR1> Start program number.
Return parameter	Return the start program number, by the "P<NR1>" string.
Example	:CHA:STAR 1 Sets to number 1 start program.

Query example :CHA:STAR?
 >P1
 Return the start program number.

Set →

→ Query

4-14-6. :PROG:MEMory

Description Query and settings for memory number of selected program steps.

Syntax :PROG:MEMory <NR1>

Query Syntax :PROG:MEMory?

Parameter <NR1> Sets the memory number.

Return parameter Return the memory number of selected, by the "Memory:M<NR1>" string.

Example :PROG:MEM 1
 Sets to 1 of memory number.

Query example :PROG:MEM?
 >Memory:M 1
 Return the memory number of selected.

Set →

→ Query

4-14-7. :PROG:OFFTime

Description Query and settings for Off time of selected program steps.

Syntax :PROG:OFFTime {<NRf> | OFF}

Query Syntax :PROG:OFFTime?

Parameter <NRf> Off time (unit is seconds)
 Setting of 0 is off Setting function.
 OFF Setting off function

Return parameter Return the Off time of selected program steps, by the "Off-Time:<NR2>" string.
 "Off-Time:0.0" is a function off.

Example :PROG:PFT 1
 Sets to 1 second Off time.

Query example :PROG:OFFT?
 >Off-Time:1.0
 Return the Off time.

Related Commands :PROG:PFTTime

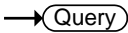
 →
 → 

4-14-8. :PROG:ONTime

Description	Query and settings for On time of selected program steps.
Syntax	:PROG:ONTime <NRf>
Query Syntax	:PROG:ONTime?
Parameter	<NRf> On time (unit is seconds)
Return parameter	Return the On time of selected program steps, by the "On-Time:<NR2>" string.
Example	:PROG:ONT 1 Sets to 1 second On time.
Query example	:PROG:ONT? >On-Time:0.1 Return in seconds On time.
Related Commands	:PROG:PFTIME :PROG:STIME

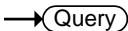
 →
 → 

4-14-9. :PROG:PFTIME

Description	Query and setting for the judgment delay time and the pass / fail judgment (Go-NoGo Test) of the program selected step.
Syntax	:PROG:PFTIME {<NRf> OFF}
Query Syntax	:PROG:PFTIME?
Parameter	<NRf> Set in seconds the decision delay time. 0 setting is off a judgment function. OFF Sets off Judgment function
Return parameter	Return the judgment delay time, by the "P/F-Time:<NR2>" string. "P/F-Time:0.0" is a function off.
Example	:PROG:PFT 1 Delay time of the judgment sets 1 second.
Query example	:PROG:PFT >P/F-Time:1.0 Return the judgment delay time.
Related Commands	:PROG:OFFTIME :PROG:ONTIME

4-14-10. :PROG_{ram}[:RECall]:DEFault

Set →

Description	Setting the initial value to all the steps of the program that is selected.
Syntax	:PROG _{ram} [:RECall]:DEFault
Example	:PROG:DEF Setting the initial value to all the steps of the program that is selected.

4-14-11. :PROG_{ram}:RUN

Set →
→ Query

Description	Query and settings for execution process of selected program steps.
Syntax	:PROG _{ram} :RUN { AUTO MANual SKIP}
Query Syntax	:PROG _{ram} :RUN?
Parameter	AUTO Sets to auto-run processing. MANual Sets to wait run. SKIP Sets to the next processing steps.
Return parameter	Return the execution process, by the "Run:{Auto Manual Skip}" string.
Example	:PROG:RUN AUTO Sets to auto-run processing.
Query example	:PROG:RUN? >Run:Auto Return the execution process.

4-14-12. :PROG_{ram}:SAVE

Set →

Description	Save program.
Syntax	:PROG:SAVE
Example	:PROG:SAVE Save program.

4-14-13. :PROG_{ram}:START

Set →
→ Query

Description	Query and setting for select program number.
Syntax	:PROG _{ram} :START <NR1>
Query Syntax	:PROG _{ram} :START?
Parameter	<NR1> Program number to select.
Return parameter	Return the Program number in selected, by the "Start:<NR1>" string.

Example	:ROG:STAR 1 Sets to 1 of program number.
Query example	:PROG:STAR? >Start:1 Return The program number chosen.

Set →

→ Query

4-14-14. :PROG:STATe

Description	Query and settings for the operation and selection of program mode.										
Syntax	:PROG:STATe {OFF ON PAUSE CONTINUE NEXT}										
Query Syntax	:PROG:STATe?										
Parameter	<table border="0"> <tr> <td>OFF</td> <td>Sets in the Off of the program mode.</td> </tr> <tr> <td>ON</td> <td>Sets in the On of the program mode.</td> </tr> <tr> <td>PAUSE</td> <td>Interruption of during program execution.</td> </tr> <tr> <td>CONTINUE</td> <td>Cancellation of the program pause.</td> </tr> <tr> <td>NEXT</td> <td>Cancellation of the program manual stop.</td> </tr> </table>	OFF	Sets in the Off of the program mode.	ON	Sets in the On of the program mode.	PAUSE	Interruption of during program execution.	CONTINUE	Cancellation of the program pause.	NEXT	Cancellation of the program manual stop.
OFF	Sets in the Off of the program mode.										
ON	Sets in the On of the program mode.										
PAUSE	Interruption of during program execution.										
CONTINUE	Cancellation of the program pause.										
NEXT	Cancellation of the program manual stop.										
Return parameter	<p>Return the status of the program mode.</p> <p>Return the on status of program mode, by the "ON,{STOP RUN PAUSE}" string. ("STOP": stopped, "RUN": running, "PAUSE": Suspended)</p> <p>Return the off status of program mode, by the "OFF" string.</p>										
Example	:PROG:STAT ON Sets in the On of the program mode.										
Query example	:PROG:STAT? >ON,STOP Return the status of the program mode.										

Set →

→ Query

4-14-15. :PROG:STEP

Description	Query and setting for the step number of the program to select.
Syntax	:PROG:STEP <NR1>
Query Syntax	: PROG:STEP?
Parameter	<NR1> Step number to select.
Return parameter	Return the step number of the program, by the "Step:<NR1>" string.
Example	:PROG:STEP 1 Sets to 1 of step number.

Query example :PROG:STEP?
 >Step:1
 Return the step number of the program.

Set →

→ Query

4-14-16. :PROG:STIME

Description	Query and setting for time of load short of selected program step.	
Syntax	:PROG:STIME <NR1>	
Query Syntax	:PROG:STIME?	
Parameter	<NRf>	Sets in time seconds of load short. 0 setting is the off feature of load short.
	OFF	Sets the off feature of load short.
Return parameter	Return the setting time of load short feature, by the "Short-Time:<NR2>" string.	
Example	:PROG:STIM 1 Sets to 1 second of load short feature.	
Query example	:PROG:STIM? >Short-Time:0.0 Return the setting time of load short feature.	
Related Commands	:PROG:ONTime	

Set →

→ Query

4-14-17. :FUNCtion[:COMPLete][:RING]:TIME

Description		
Syntax	:FUNCtion[:COMPLete][:RING]:TIME<NR1> MINimum MAXimum INFINit	
Query Syntax	:FUNCtion[:COMPLete][:RING]:TIME? [MINimum MAXimum]	
Parameter	<NR1>	Set to Ring time.[s]
	MINimum	Minimum Ring time
	MAXimum	Maximum Ring time
	INFINity	Continue
Return parameter	<NR1>	Ringing time[s]
	INFINity	Continue
	OFF	None
Example	:FUNC:TIME 5 Set ring times to 5sec.	

Query example :FUNC:TIME?
 >5
 Ring time is 5sec

4-15.Normal sequence Commands

Set →

4-15-1. :NSEquence

→ Query

Description	Query and settings for all parameters to specified sequence number of the normal sequence.	
	Note:Can not change the range and mode of the load when there is a step data.	
Syntax	:NSEquence (1),(2),(3),(4),(5),(6),(7),(8),(9)	
Query Syntax	:NSEquence?	
Parameter	(1) <NR1> (2) <NR1> (3) <ASCII string> (4) <ASCII string> (5) <ASCII string> (6) <ASCII string> (7) <ASCII string> (8) <NRf> (9) <ASCII string>	Sets the start sequence number. Sets the sequence number. Sets the note of up to 12 characters. Enclose the string in double coat. Sets the load mode. {CC CR CV CP} Sets the load range. {IHVH IMVH ILVH IHVL IMVL ILVL} Sets the loop count of the sequence. <NR1> 0 is infinite times. 1~9999. INFinity Sets the load condition setting after the end. {ON OFF} Sets the load value after the end. (Load condition is enabled by ON.) Sets the chain of the next sequence. <NR1> Sequence number OFF No chain
Return parameter	(1) <ASCII string> (2) <ASCII string> (3) <ASCII string> (4) <ASCII string> (5) <ASCII string>	Return whether it is in normal sequence mode. {ON OFF} Return the start sequence number setting. Return the sequence number setting. Return the contents of the memo. Return the load mode setting. {CC CR CV CP}

(6) <ASCII string>	Return the load range setting. {IHVH IMVH ILVH IHVL IMVL ILVL}
(7) <ASCII string>	Return the loop count of the sequence. (Infinite times is the string "Infinity".)
(8) <ASCII string>	Return the load condition mode after the end. {ON OFF}
(9) <ASCII string>	Return the load setting after the end.
(10) <ASCII string>	Return the chain setting of the next sequence. (No-chain is a string "OFF".)

Example :NSEQ 1,1,"ABC",CC,ILVL,5,ON,1.5000,OFF
Sets a parameter to a specified sequence number and the start number of sequence.

Query example :NSEQ?
>NSeq:ON; Start:1, Seq No:1, Memo:ABC, Mode:CC, Range:ILVL, Loop:5, Last Load:ON, Last:1.5000, Chain:Off
Return the parameters of the program step that is selected after the state of the normal sequence mode.

Set →

→ Query

4-15-2. :NSEquence:CHAI

Description	Query and settings for the chain of normal sequence that is selected.
Syntax	:NSEquence:CHAI {<NR1> OFF}
Query Syntax	:NSEquence:CHAI?
Parameter	<NR1> Sets normal sequence number chain. 0 is end the chain. OFF chain is end.
Return parameter	Return the chain of Normal sequence number, by the "Chain: {<NR1> Off}" string. "Off" is the end of the chain.
Example	:NSEQ:CHA 1 Sets 1 to program chain.
Query example	:NSEQ:CHA? >Chain:1 Return the setting value of the program chain.

4-15-3. :NSEquence[:DEL]:ALL

Set →

Description	Delete all the steps of the normal sequence that is selected.
Syntax	:NSEquence[:DEL]:ALL
Example	:NSEQ:ALL Delete all the steps of the normal sequence that is selected.

Set →

4-15-4. :NSEquence:EDIT

→ Query

Description	Query and settings for step data of normal sequence.	
Syntax	:NSEquence:EDIT (1),(2),(3),(4),(5),(6),(7),(8),(9),(10),(11)	
Query Syntax	:NSEquence:EDIT?	
Parameter	(1) <NR1> (2) <NR1> (3) <NRf> (4) <NR1> (5) <NR1> (6) <NR1> (7) <NR1> (8) <ASCII string> (9) <ASCII string> (10) <ASCII string> (11) <ASCII string>	Is the step number you want to edit. The total number of steps. Sets a load value of operation mode. Sets hours. Sets minute. Sets seconds. Sets milliseconds. Output setting of the load. {ON OFF} Lamp operation setting. {ON OFF} Trigger Output setting. {ON OFF} Setting the pause. {ON OFF}
Return parameter	(1) <ASCII string> (2) <ASCII string> (3) <ASCII string> (4) <ASCII string> (5) <ASCII string> (6) <ASCII string> (7) <ASCII string>	Return the Edit step / step total. Return the setting value of the load of the operating mode. Return the set time. Return the setting of the output load. Return the setting of the lamp operation. Return the setting of TRIG OUT. Return the setting of pause.
Example	:NSEQ:EDIT 1,2,1,1,2,3,4,OFF,OFF,OFF,OFF Sets the data of normal step sequence program.	

Query example :NSEQ:EDIT?
 >Step:1/1, Value:0, Time:0H:0M:0S:1mS, LOAD:OFF,
 TRIG OUT:OFF, RAMP:OFF, PAUSE:OFF
 Return the data of normal step sequence program that
 is selected.

→ Set →

4-15-5. :NSEquence:EDIT:POINT

→ Query

Description Query and settings for current edit step number of
 the normal sequence.

Syntax :NSEquence:EDIT:POINT {<NR1>}

Query Syntax :NSEquence:EDIT:POINT?

Parameter <NR1> The step number you want to edit.
 1~1000

Example :NSEquence:EDIT:POINT 10
 Set step number for edit to 10.

4-15-6. :NSEquence:EDIT:END

→ Query

Description Query for last step number of the normal sequence.

Query Syntax :NSEquence:EDIT:END?

Parameter <NR1> 1~1000

Query example :NSEquence:EDIT:END?
 > 20
 The last number of normal sequence step is 20.

→ Set →

4-15-7. :NSEquence:LAST

→ Query

Description Query and settings for load value after the end of the
 normal sequence.

Syntax :NSEquence:LAST <NRf>

Query Syntax :NSEquence:LAST?

Parameter <NRf> Sets load value after the end of step.

Return parameter Return load value of after the step the end, by the
 "Last:<NR2>" string.

Example :NSEQ:LAST 1
 Sets load value of after the step the end.

Query example :NSEQ:LAST?
 >Last:1.00
 Return load value of after the step the end.

Related Commands :NSEquence:LLOAD

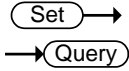

4-15-8. :NSEquence:LLOAD

Description Query and settings for output setting after the end of the normal sequence.

Syntax :NSEquence:LLOAD {ON | OFF}

Query Syntax :NSEquence:LLOAD?

Parameter ON Turn on the output setting of the load after the end of step.
 OFF Turn off the output setting of the load after the end of step.

Return parameter Return the output setting of the load after the end of the step , by the "Last Load:{ON | OFF}" string.

Example :NSEQ:LLOAD ON
 Sets the output setting of the load after the end of the step.

Query example :NSEQ:LLOAD?
 >Last Load:OFF
 Return the output setting of the load after the end of the step.

Related Commands :NSEquence:LAST

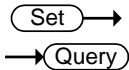

4-15-9. :NSEquence:LOOP

Description Query and setting for number of loops of normal sequence.

Syntax :NSEquence:LOOP {<NR1> | INFinity }

Query Syntax :NSEquence:LOOP?

Parameter <NR1> Loop count setting. (1~9999)
 INFinity Infinite number of times.

Return parameter Return the number of loops of normal sequence, by the "Loop:{<NR1> | Infinity}" string.

Example :NSEQ:LOOP 1
 Sets 1 to loop count of normal sequence.

Query example :NSEQ:LOOP?
 >Loop:Infinity
 Return the loop number of normal sequence.

Set →
 → Query

4-15-10. :NSEquence:MEMO

Description	Query and setting for the memo of normal sequence that is selected.
Syntax	:NSEquence:MEMO <ASCII string>
Query Syntax	:NSEquence:MEMO?
Parameter	<ASCII string> Set the characters up to 12 characters. Enclose the string in double coat.
Return parameter	Return the memo of normal sequence that is selected, by the "Memo:<ASCII string>" string.
Example	:NSEQ:MEMO "ABCD" Sets the memo of step.
Query example	:NSEQ:MEMO? >Memo:ABCD Return the memo of step.

Set →
 → Query

4-15-11. :NSEquence:MODE

Description	Query and setting for the operating mode of the normal sequence program that is selected.
Syntax	:NSEquence:MODE {CC CR CV CP}
Query Syntax	:NSEquence:MODE?
Parameter	CC Sets to constant current mode. CR Sets to constant resistance mode. CV Sets to constant voltage mode. CP Sets to constant power mode.
Return parameter	Return the operating mode of the normal sequence program that is selected, by the "Mode:{CC CR CV CP}" string.
Example	:NSEQ:MODE CC Sets the operating mode of the normal sequence.
Query example	:NSEQ:MODE? >Mode:CC Return the operating mode of the normal sequence.

Set →
 → Query

4-15-12. :NSEquence:NUMBER

Description	Query and setting for the sequence number of the normal sequence.
Syntax	:NSEquence:NUMBER <NR1>
Query Syntax	:NSEquence:NUMBER?

Parameter	<NR1>	Sets the sequence number.
Return parameter	Return the sequence number of the normal sequence by the "Seq No:<NR1>" string.	
Example	:NSEQ:NUMB 1	Sets to 1 of normal sequence number.
Query example	:NSEQ:NUMB? >Seq No:1	Return a sequence number that is selected.

(Set) →

4-15-13. :NSEquence:RANGe

→ (Query)

Description	Query and setting for the operating range of the normal sequence that is selected.	
Syntax	:NSEquence:RANGe { IHVH IMVH ILVH IHVL IMVL ILVL }	
Query Syntax	:NSEquence:RANGe?	
Parameter	IHVH	Sets High current range and High voltage range.
	IMVH	Sets Middle current range and High voltage range.
	ILVH	Sets Low current range and High voltage range.
	IHVL	Sets High current range and Low voltage range.
	IMVL	Sets Middle current range and Low voltage range.
	ILVL	Sets Low current range Low voltage range.
Return parameter	Return the operating range of the normal sequence that is selected, by the "Range:{IHVH IMVH ILVH IHVL IMVL ILVL}" string.	
Example	:NSEQ:RANG IHVL	Sets operating of High current range and Low voltage range.
Query example	:NSEQ:RANG? > Range:IHVL	Return the operating range of settings.

4-15-14. :NSEquence:SAVE

(Set) →

Description	Save program of normal sequence.
Syntax	:NSEquence:SAVE

Example :NSEQ:SAVE
Save program of normal sequence.

Set →

4-15-15. :NSEquence:START

→ Query

Description Query and setting for the start sequence number of the normal sequence.

Syntax :NSEquence:START <NR1>

Query Syntax :NSEquence:START?

Parameter <NR1> Sets the start sequence number.

Return parameter Return the start sequence number of the normal sequence, by the "Start:<NR1>" string.

Example :NSEQ:STAR 1
Sets the start sequence number of the normal sequence.

Query example :NSEQ:STAR?
>Start:1
Return the start sequence number of normal sequence.

Set →

4-15-16. :NSEquence:STATE

→ Query

Description Query and settings for the operation and selection of the normal sequence mode.

Syntax :NSEquence:STATE {OFF|ON|PAUSE|CONTINUE|EXT}

Query Syntax :NSEquence:STATE?

Parameter OFF Sets in the Off of the normal sequence mode.
ON Sets in the On of the normal sequence mode.
PAUSE Interruption of during program execution.
CONTINUE Cancellation of the normal sequence pause.
NEXT Cancellation of the normal sequence manual stop.

Return parameter Return the status of the normal sequence mode. Return the on status of the normal sequence mode, by the "ON,{STOP | RUN | PAUSE}" string. ("STOP": stopped, "RUN": running, "PAUSE": Suspended) Return the off status of the normal sequence mode, by the "OFF" string.

Example :PROG:STAT ON
Sets in the On of the normal sequence mode.

Query example :PROG:STAT?
 >ON,STOP
 Return the status of the normal sequence mode.

4-16.Fast sequence Commands

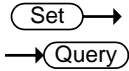

4-16-1. :FSEquence

Description	Query and settings for all parameters of the fast sequence.	
Syntax	:FSEquence (1),(2),(3),(4),(5),(6),(7)	
Query Syntax	:FSEquence?	
Parameter	(1) <ASCII string>	Sets the note of up to 12 characters. Enclose the string in double coat.
	(2) <ASCII string>	Sets the load mode. {CC CR}
	(3) <ASCII string>	Sets the load range. {IHVH IMVH ILVH IHVL IMVL ILVL}
	(4) <ASCII string>	Sets the loop count of the sequence. <NR1> 0 is infinite times. 1~9999. INFINITY
	(5) <NRf>	Sets the time base. (unit is seconds)
	(6) <ASCII string>	Sets the load condition setting after the end. {ON OFF}
	(7) <NRf>	Sets the load value after the end. (Load condition is enabled by ON.)
	(8) <NR1>	Sets the step number setting of the loop last.
Return parameter	(1) <ASCII string>	Return whether it is in fast sequence mode. {ON OFF}
	(2) <ASCII string>	Return the contents of the memo.
	(3) <ASCII string>	Return the load mode setting. {CC CR }
	(4) <ASCII string>	Return the load range setting.{IHVH IMVH ILVH IHVL IMVL ILVL}
	(5) <ASCII string>	Return the loop count of the sequence. (Infinite times is the string "Infinity".)
	(6) <ASCII string>	Return the time base. (unit is miri seconds)
	(7) <ASCII string>	Return the load condition mode after the end. {ON OFF}

- (8) <ASCII string> Return the load setting after the end.
- (9) <ASCII string> Return the step number of the last loop.

Example	:FSEQ "ABC",CC,IHVL,1,0.025,OFF,1.0,1 Sets the parameters to the timing of the fast sequence mode.
Query example	:FSEQ? > FSeq:OFF; Memo:ABC, Mode:CC, Range:IHVL, Loop:1, Time Base:25.000, Last Load:OFF, Last:1.00, RPTSTEP:1 Return the contents of the timing after the state of fast sequence mode.

4-16-2. :FSEquence[:DELet]:ALL (Set) →

Description	Delete all programs of the fast sequence.
Syntax	:FSEquence[:DELet]:ALL
Example	:FSEQ:ALL Delete all programs of the fast sequence.

4-16-3. :FSEquence:EDIT → (Query)

Description	Query and setting for data of fast sequence.
Syntax	:FSEquence:EDIT (1),(2),(3),(4)
Query Syntax	:FSEquence:EDIT?
Parameter	(1) <NR1> Editing step. (2) <NR1> Step total number. (3) <NRf> Sets the load value of the operation mode. (4) <ASCII string> Sets the TRIG OUT. {ON OFF}
Return parameter	(1) <ASCII string> Return the total of an edit step and a step. (2) <ASCII string> Return the load setting value of the operation mode. (3) <ASCII string> Return the TRIG OUT.
Example	:FSEQ:EDIT 2,6,1,ON Sets the data of the fast sequence.
Query example	:FSEQ:EDIT? > Step:0001/0003; Value:0.00, TRIG OUT:OFF Return the data of the fast sequence.

Set →
 → Query

4-16-4. :FSEquence:EDIT:POINT

Description	Query and settings for current edit step number of the fast sequence.	
Syntax	:FSEquence:EDIT:POINT {<NR1>}	
Query Syntax	:FSEquence:EDIT:POINT?	
Parameter	<NR1>	The step number you want to edit. 1~1000
Example	:FSEquence:EDIT:POINT 10 Set step number for edit to 10.	

4-16-5. :FSEquence:EDIT:END

→ Query

Description	Query for last step number of the fast sequence.	
Query Syntax	:FSEquence:EDIT:END?	
Parameter	<NR1>	1~1000
Query example	:FSEquence:EDIT:END? > 20 The last number of fast sequence step is 20.	

Set →
 → Query

4-16-6. :FSEquence[:EDIT]:FILL

Description	Query and setting for FILL of fast sequence.	
Syntax	:FSEquence[:EDIT]:FILL (1),(2),(3),(4)	
Query Syntax	:FSEquence[:EDIT]:FILL?	
Parameter	(1) <NRf>	Sets the start load value of the operating mode.
	(2) <NRf>	Sets the end load value of the operating mode.
	(3) <NR1>	Sets the step number of start.
	(4) <NR1>	Sets the step number of end.
Return parameter	(1)<ASCII string>	Return the start load value of the operating mode.
	(2)<ASCII string>	Return the end load value of the operating mode.
	(3)<ASCII string>	Return the step number of start.
	(4)<ASCII string>	Return the step number of end.

Example	:FSEQ:FILL 0,5,1,6 Sets the terms of the FILL to Fast sequence program.
Query example	:FSEQ:FILL? >Start Value:0.00, End Value:5.00, Start Step:1, End Step:6 Return the setting value of FILL of fast sequence.

(Set) →

→ (Query)

4-16-7. :FSEquence:LAST

Description	Query and setting for the load value after the end of Fast sequence.
Syntax	:FSEquence:LAST <NRf>
Query Syntax	:FSEquence:LAST?
Parameter	<NRf> Sets the load setting value of after the end of step. (It is enabled by load conditions ON.)
Return parameter	Return the load setting value of after the end of step, by the "Last:<NR2>" string.
Example	:FSEQ:LAST1 Sets the load setting value of after the end of step.
Query example	:FSEQ:LAST? >Last:0.070000 Return the load setting value of after the end of step.
Related Commands	:FSEquence:LLOAD

(Set) →

→ (Query)

4-16-8. :FSEquence:LLOAD

Description	Query and setting for enabled-disabled of load setting of after the end of Fast sequence.
Syntax	:FSEquence:LLOAD {ON OFF}
Query Syntax	:FSEquence:LLOAD?
Parameter	ON Enable the load setting of step after the end. OFF Disable the load setting of step after the end.
Return parameter	Return enable-disable of load setting of step after the end , by the "Last Load:{ON OFF}" string.
Example	:FSEQ:LLOAD ON Enable the load setting of step after the end.

Query example :FSEQ:LLOAD?
 >Last Load:OFF
 Return enable-disable of load setting of step after the end.

Related :FSEquence:LAST
 Commands

Set →

4-16-9. :FSEquence:LOOP

→ Query

Description Query and setting for number of loops of fast sequence.

Syntax :FSEquence:LOOP {<NR1> | INFINITY }

Query Syntax :FSEquence:LOOP?

Parameter <NR1> Loop count setting. (1~9999)
 INFINITY Infinite number of times.

Return parameter Return the number of loops of fast sequence, by the "Loop:{<NR1> | Infinity}" string.

Example :FSEQ:LOOP 1
 Sets 1 to loop count of fast sequence.

Query example :FSEQ:LOOP?
 >Loop:Infinity
 Return the loop number of fast sequence.

Set →

4-16-10. :FSEquence:MEMO

→ Query

Description Query and setting for the memo of fast sequence.

Syntax :FSEquence:MEMO <ASCII string>

Query Syntax :FSEquence:MEMO?

Parameter <ASCII string> Set the characters up to 12 characters.
 Enclose the string in double coat.

Return parameter Return the memo of fast sequence, by the "Memo:<ASCII string>" string.

Example :FSEQ:MEMO "ABC"
 Sets the memo of fast sequence.

Query example :FSEQ:MEMO?
 >Memo: ABCD
 Return the memo of fast sequence.

Set →

4-16-11. :FSEquence:MODE

→ Query

Description Query and setting for the operating mode of fast sequence.

Syntax :FSEquence:MODE {CC | CR}

Query Syntax	:FSEquence:MODE?
Parameter	CC Sets to constant current mode. CR Sets to constant resistance mode.
Return parameter	Return the operating mode of fast sequence, by the "Mode:{CC CR}" string.
Example	:FSEQ:MODE CC Sets the operating mode of the fast sequence.
Query example	:FSEQ:MODE? >Mode:CC Return the operating mode of the fast sequence.

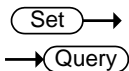

4-16-12. :FSEquence:RANGe

Description	Query and setting for the operating range of the fast sequence that is selected.
Syntax	:FSEquence:RANGe { IHVH IMVH ILVH IHVL IMVL ILVL}
Query Syntax	:FSEquence:RANGe?
Parameter	IHVH Sets High current range and High voltage range. IMVH Sets Middle current range and High voltage range. ILVH Sets Low current range and High voltage range. IHVL Sets High current range and Low voltage range. IMVL Sets Middle current range and Low voltage range. ILVL Sets Low current range Low voltage range.
Return parameter	Return the operating range of the fast sequence that is selected, by the "Range:{IHVH IMVH ILVH IHVL IMVL ILVL}" string.
Example	:FSEQ:RANG IHVL Sets operating of High current range and Low voltage range.
Query example	:FSEQ:RANG? >Range:IHVH Return the operating range of settings.

Set →
 → Query

4-16-13. :FSEquence:RPTStep

Description	Query and setting for step number of the loop end of the fast sequence.
Syntax	:FSEquence:RPTStep <NR1>
Query Syntax	:FSEquence:RPTStep?
Parameter	<NR1> Sets the step number of the last loop.
Return parameter	Return the step number of the loop end of the fast sequence, by the "RPTSTEP:<NR1>" string.
Example	:FSEQ:RPTS 1 Sets the step number of the last loop.
Query example	:FSEQ:RPTS? >RPTSTEP:1 Return the step number of the last loop.

4-16-14. :FSEquence:SAVE

Set →

Description	Save program of fast sequence.
Syntax	:FSEquence:SAVE
Example	:FSEQ:SAVE Save program of fast sequence.

Set →
 → Query

4-16-15. :FSEquence:TBASe

Description	Query and setting for the time-based of fast sequence.
Syntax	:FSEquence:TBASe <NRf>
Query Syntax	:FSEquence:TBASe?
Parameter	<NRf> Sets the time-base. (Unit is second.)
Return parameter	Return the time-based of fast sequence, by the "Time Base:<NR2>" string.
Example	:FSEQ:TBAS 0.6 Sets the 0.6 seconds to the time-base of fast sequence.
Query example	:FSEQ:TBAS? >Time Base:0.60000 Return the time-base.

Set →
 → Query

4-16-16. :FSEquence:STATE

Description	Query and settings for the operation and selection of the fast sequence mode.
Syntax	:FSEquence:STATE {OFF ON}

Query Syntax	:FSEquence:STATe?
Parameter	OFF Sets in the Off of the fast sequence mode. ON Sets in the On of the fast sequence mode.
Return parameter	Return the on status of the fast sequence mode, by the "ON,{STOP RUN }" string. ("STOP": stopped, "RUN": running) Return the off status of the normal sequence mode, by the "OFF" string.
Example	:FSEQ:STAT ON Sets in the On of the fast sequence mode.
Query example	:FSEQ:STAT? >ON,STOP Return the status of the fast sequence mode.

4-17.OCP Test Commands

To execute / stop the test, use: INPUT command.

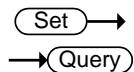

4-17-1. :OCP:STATe

Description	Sets or returns the state of the OCP function.	
Syntax	:OCP:STATe {<bool> OFF ON}	
Query Syntax	:OCP:STATe?	
Parameter	ON / 1 OFF / 0	Turns the OCP function on Turns the OCP function off
Return Parameter [^]	ON OFF	OCP function is on. OCP function is off.
Return	Return the OCP function state.	
example	:OCP:STATe ON Turns the OCP function on.	
Query example	:OCP:STATe? OFF Indicates that the OCP function is turned off	

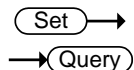

4-17-2. :OCP:EDIT[:CHANnel]

Description	
Syntax	:OCP:EDIT[:CHANnel]{<NR1>,LOW MIDDLE HIGH,<NR2>,<NR2>,<NR2>,<NR2>,<NR2>,<NR2>}

Parameter	<NR1> LOW MIDDLE HIGH	Memory Number Current Range
	<NR2>	Start Current value
	<NR2>	Stop Current Value
	<NR2>	Current Step Value
	<NR2>	Time Step Value
	<NR2>	Delay Time Value
	<NR2>	Trigger Voltage
	<NR2>	steady state current after test has finished
example	:OCP:EDIT 1, LOW, 0.5, 5.0, 0.1, 0.25, 0, 5.0, 1.0	
Query Syntax	:OCP:EDIT?	
Return Parameter	<string>	Temp:<Seq_1~Seq_12>,Range:<High Middle Low>, Start C:<NR2>, End C:<NR2>, Step C:<NR2>,Step T:<NR2>, Delay:<NR2>, TrigV :<NR2>, Last C:<NR2>

Query example :OCP:EDIT?
Temp:Seq_1, Range:High, Start C:0.36749, EndC:0.36750, Step C:0.00001, Step T:5.00, Delay:0.00,TrigV:0.01, Last C:0.00000

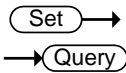

4-17-3. :OCP[:CHANnel]:NUMBER

Description	Sets or queries the OCP memory number	
Syntax	:OCP[:CHANnel]:NUMBER <NR1>	
Query Syntax	:OCP[:CHANnel]:NUMBER?	
Parameter	<NR1>	Sets the OCP memory number
Return	Returns the OCP memory number	
example	:OCP:NUMB 1 Sets the OCP number is 1.	

Query example :OCP:NUMB?
1
The OCP number is 1.

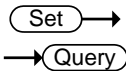

4-17-4. :OCP[:CHANnel]:RANGe

Description	Sets or queries the channel range.	
Syntax	:OCP[:CHANnel]:RANGe {LOW MIDDLE HIGH}	
Query Syntax	:OCP[:CHANnel]:RANGe?	
Parameter	LOW	CC Mode Low range.
	MIDDLE	CC Mode Middle range.

	HIGH	CC Mode High range.
Return	Return the OCPtest current range.	
example	:OCP:RANG LOW Set CC Mode Low range.	
Query example	:OCP:RANG? Low The range is CC Mode Low range.	

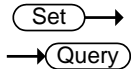

4-17-5. :OCP[:CHANnel]:START

Description	Sets or queries the starting current value.	
Syntax	:OCP[:CHANnel]:START {<NR2>}	
Query Syntax	:OCP[:CHANnel]:START?	
Parameter	<NR2>	The START current value in Amps.
Return	Return the START current value in Amps.	
example	:OCP:STAR 2 Set the start current to 2A.	
Query example	:OCP:STAR? 0.1000 Returns the starting current as 0.1A.	

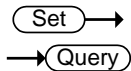

4-17-6. :OCP[:CHANnel]:END

Description	Sets the ending current value for the test. The value must be higher than the DUT OCP value.	
Syntax	:OCP[:CHANnel]:END {<NR2>}	
Query Syntax	:OCP[:CHANnel]:END?	
Parameter	<NR2>	The END current value in Amps.
Return	Return the END current value in Amps.	
example	:OCP:END 2 Set the END current to 2A.	
Query example	:OCP:END? 0.1000 Returns the END current as 0.1A.	

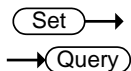

4-17-7. :OCP[:CHANnel]:STEP:CURRent

Description	Sets the current step resolution for the OCP Test Automation.	
-------------	---	--

Syntax	:OCP[:CHANnel]: STEP:CURRent {<NR2>}
Query Syntax	:OCP[:CHANnel]: STEP:CURRent?
Parameter	<NR2> The current value in Amps.
Return	Returns the current step resolution in Amps.
example	:OCP:STEP:CURR 0.1 Set the step resolution as 0.1A.

Query example :OCP:STEP:CURR?
0.1000
Returns the step resolution as 0.1A.

Set →

→ Query

4-17-8. :OCP[:CHANnel]:LAST

Description	Sets or queries the current value for after the DUT OCP protection has been activated.
Syntax	:OCP[:CHANnel]:LAST {<NR2>}
Query Syntax	:OCP[:CHANnel]:LAST?
Parameter	<NR2> The current value in Amps.
Return	Returns the current value in Amps.
example	:OCP:LAST 2 Set the current value to the maximum value.

Query example :OCP:LAST?
0.1000
Returns the current value.

Set →

→ Query

4-17-9. :OCP[:CHANnel]:STEP:TIME

Description	Queries or sets how long the step times are for the OCP Test Automation function.
Syntax	:OCP[:CHANnel]:STEP:TIME {<NR2>}
Query Syntax	:OCP[:CHANnel]:STEP:TIME?
Parameter	<NR2> The step time in seconds.
Return	Return the step time in seconds.
example	:OCP:STEP:TIME 2 Set the step time to 2second.

Query example :OCP:STEP:TIME?
0.10
Returns the step time.

4-17-10. :OCP[:CHANnel]:DElay

Set →
→ Query

Description	Queries or sets the test delay time for the OCP Test Automation function.
Syntax	:OCP[:CHANnel]:DElay {<NR2>}
Query Syntax	:OCP[:CHANnel]:DElay:TIME?
Parameter	<NR2> The delay time in seconds
Return	Return the delay time in seconds
example	:OCP:DElay 2 Set the delay time to 2s.
Query example	:OCP:DElay? 0.10 Returns the delay time in seconds

Set →
→ Query

4-17-11. :OCP[:CHANnel]:TRIGger

Description	Queries or sets the voltage trigger for when the power supply OCP has been triggered.
Syntax	:OCP[:CHANnel]:TRIGger {<NR2>}
Query Syntax	:OCP[:CHANnel]:TRIGger?
Parameter	<NR2> The trigger voltage level.
Return	Return the trigger voltage level.
example	:OCP:TRIG 2 Set the trigger voltage level to 2V.
Query example	:OCP:TRIG? 2.0 Returns the trigger level.

4-17-12. :OCP:CHANnel:STATus

→ Query

Description	Queries the status of the OCP Test Automation function.
Query Syntax	:OCP:CHANnel:STATus?
Return	0 Test ended
Parameter	1 OCP test active
Query example	:OCP:CHAN:STAT? 0 The test has ended.

4-17-13. :OCP:RESult

→ Query

Description	Returns the OCP Test Automation results.
Query Syntax	:OCP:RESult?
Return Parameter	<NR2>,<NR2> Returns the OCP current, voltage.
Query example	:OCP:RES? 3.6750,0.10 OCP Current:3.675A, OCPVoltage:0.10V

4-17-14. :OCP:SAVE

Set →

Description	Saves the current COP Test Automation parameters.
Syntax	:OCP:SAVE

4-17-15. :OCP:RUN

Set →

Description	Turns the load on for the OCP Test Automation function. Same as :INPUT ON command.
Syntax	:OCP:RUN

4-18.Utility Commands

Set →

4-18-1. :UTILity:ALARm

→ Query

Description	Query and setting for the speaker sound of the alarm the time.
Syntax	:UTILity:ALARm {< Boolean > ON OFF}
Query Syntax	:UTILity:ALARm?
Parameter	ON or 1 Sets ON of the speaker sound of the alarm the time. OFF or 0 Sets OFF of the speaker sound of the alarm the time.
Return parameter	Return the speaker sound of the alarm the time, by the "{On Off}" string.
Example	:UTIL:ALAR ON Sets the speaker sound of the alarm the time.
Query example	:UTIL:ALAR? >On Return the speaker sound of the alarm the time.

Set →
 → Query

4-18-2. :UTILity:BRiGhtness

Description	Query and setting for brightness of the LCD display.
Syntax	:UTILity:BRiGhtness <NR1>
Query Syntax	:UTILity:BRiGhtness?
Parameter	<NR1> Sets brightness of the LCD display.
Example	:UTIL:BRI 70 Sets the 70 at brightness of the LCD display.
Query example	:UTIL:BRI? >70 Return brightness of the LCD display.

Set →
 → Query

4-18-3. :UTILity:CONTRast

Description	Query and setting for the contrast of the LCD display.
Syntax	:UTILity:CONTRast <NR1>
Query Syntax	:UTILity:CONTRast?
Parameter	<NR1> Sets contrast of the LCD display.
Example	:UTIL:CONT 8 Sets the 8 at contrast of the LCD display.
Query example	:UTIL:CONT? >8 Return contrast of the LCD display.

Set →
 → Query

4-18-4. :UTILity:GNG

Description	Query and setting for the speaker sound of the "Go-NoGo" judgment time.
Syntax	:UTILity:GNG {< Boolean > ON OFF}
Query Syntax	:UTILity:GNG?
Parameter	ON or 1 Sets ON of the speaker sound of the "Go-NoGo" judgment time. OFF or 0 Sets OFF of the speaker sound of the "Go-NoGo" judgment time.
Return parameter	Return the speaker sound of the "Go-NoGo" judgment time, by the "{On Off}" string.
Example	:UTIL:GNG ON Sets the speaker sound of the "Go-NoGo" judgment time.

Query example :UTIL:GNG?
 >On
 Return the setting of the speaker sound of the "Go-NoGo" judgment time.

Set →

4-18-5. :UTILity:KNOB

→ Query

Description	Query and setting for operational setting of the knob.
Syntax	:UTILity:KNOB { UPdated OLD }
Query Syntax	:UTILity:KNOB?

Parameter	UPdated	Sets real-time updates.
	OLD	Sets update at the settlement after Enter.

Return parameter	Return the operational settings of the knob, by the "{Updated Old}" string.
------------------	---

Example	:UTIL:KNOB UPD Sets the operation of the knob.
---------	---

Query example	:UTIL:KNOB? >Updated Return the operational settings of the knob.
---------------	---

Set →

4-18-6. :UTILity:LANGuage

→ Query

Description	Query and setting for the language of the operation panel. Note:Language is English only.
-------------	---

Syntax	:UTILity:LANGuage ENGLISH
--------	---------------------------

Query Syntax	:UTILity:LANGuage?
--------------	--------------------

Parameter	ENGLISH	Sets to english language.
-----------	---------	---------------------------

Return parameter	Return the language of the operation panel, by the "English" string.
------------------	--

Example	:UTIL:LANG ENGL Sets to english language.
---------	--

Query example	:UTIL:LANG? >English Return the language.
---------------	---

Set →

4-18-7. :UTILity:LOAD

→ Query

Description	Query and setting for the load operating mode or load operation at power on.
-------------	--

Syntax	:UTILity:LOAD {ON OFF LOAD PROG NSEQ FSEQ}
Query Syntax	:UTILity:LOAD?
Parameter	ON Sets on the load operating. OFF Sets off the load operating. LOAD Sets to normal operation mode. PROG Sets to program operation mode. NSEQ Sets to normal sequence mode. FSEQ Sets to fast sequence mode mode.
Return parameter	<ASCII string> Return the load operation. {On Off} Return the load operating mode or load operation at power on, by the "Load:{On Off}, Load On:{Load Prog NSeq FSeq}" string.
Example 1	:UTIL:LOAD ON Sets on the load operating at power on.
Example 2	:UTIL:LOAD PROG Sets to program operation mode at power on.
Query example	:UTIL:LOAD? >Load:Off, Load On:Prog Return the load operating mode and load operation at power on.

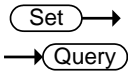

4-18-8. :UTILity:LOAD:MODE

Description	Query and setting for the Load off when operating mode is changed.
Syntax	:UTILity:LOAD:MODE {< Boolean > ON OFF}
Query Syntax	:UTILity:LOAD:MODE?
Parameter	ON or 1 Sets on the Load off when operating mode is changed. OFF or 0 Sets off the Load off when operating mode is changed.
Return parameter	Return the setting value of the Load off when operating mode is changed, by the "{On Off}" string.
Example	:UTIL:LOAD:MODE ON Sets on the Load off when operating mode is changed.
Query example	:UTIL:LOAD:MODE? >On Return the setting value of the Load off when operating mode is changed.

Set →
 → Query

4-18-9. :UTILity:LOAD:RANGe

Description	Query and setting for the Load off when range mode is changed.	
Syntax	:UTILity:LOAD:RANGe {< Boolean > ON OFF}	
Query Syntax	:UTILity:LOAD:RANGe?	
Parameter	ON or 1	Sets on the Load off when range is changed.
	OFF or 0	Sets off the Load off when range is changed.
Return parameter	Return the setting value of the Load off when range is changed, by the "{On Off}" string.	
Example	:UTIL:LOAD:RANG ON Sets on the Load off when range is changed.	
Query example	:UTIL:LOAD:RANG? >On Return the setting value of the Load off when range is changed.	

4-18-10. :UTILity:REMOte

Set →

Description	Setting for the REMOTE mode(Keylocked)	
Syntax	:UTILity:REMOte {< Boolean > ON OFF}	
Parameter	ON or 1	Sets to the remote moe.
	OFF or 0	Sets to the local mode.
Example	:UTIL:REM OFF Sets to local mode.	

4-18-11. :UTILity:REMOte:MODE

Set →

Description	Setting Reflesh time for display.	
Syntax	:UTILity:REMOte:MODE {< Boolean > FAST NORMAL}	
Parameter	FAST or 1	Set to fast response mode.
	NORMal or 0	Set to normal response mode
Example	:UTIL:REM:MODE NORMAL Sets on the normal display.	

Set →
 → Query

4-18-12. :UTILity:SPEAKER

Description	Query and setting for the speakers sound during scrolling and key input.	
Syntax	:UTILity:SPEAKER {< Boolean > ON OFF}	
Query Syntax	:UTILity: SPEAKER?	

Parameter	ON or 1 OFF or 0	Sets on the speakers sound during scrolling and key input. Sets off the speakers sound during scrolling and key input.
Return parameter	Return the setting value of speaker sound during scrolling and key input, by the "{On Off}" string.	
Example	:UTIL:SPEA ON Sets on the speakers sound during scrolling and key input.	
Query example	:UTIL:SPEA? >On Return the setting value of speaker sound during scrolling and key input.	

4-18-13. :UTILity:SYStem

→ Query

Description	Query for model number, serial number, and firmware version.	
Query Syntax	:UTILity:SYStem?	
Return parameter	<ASCII string> <NR1> <ASCII string>	Return the model name. Return the serial number. Return the firmware version.
Query example	:UTIL:SYS? >LSG-175,12345678,V1.01.001 Return the model number, serial number, and firmware version.	

Set →

4-18-14. :UTILity:TIMe

→ Query

Description	Query and setting for the date and time.	
Syntax	:UTILity:TIMe (1),(2),(3),(4),(5)	
Query Syntax	:UTILity:TIMe?	
Parameter	(1) <NR1> (2) <NR1> (3) <NR1> (4) <NR1> (5) <NR1>	Sets the month. Sets the day. Sets the year. Sets the hour. Sets the minutes.
Return parameter	(1) <NR1> (2) <NR1> (3) <NR1> (4) <NR1> (5) <NR1>	Return the month. Return the day. Return the year. Return the hour. Return the minutes.

Example	:UTIL:TIM 9,1,2013,10,11 Sets the date and time.
Query example	:UTIL:TIM? >Month:9, Day:1, Year:2013, Hour:10, Minute:11 Return the date and time.

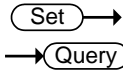

4-18-15. :UTILity:UNReg

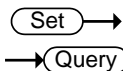

Description	Query and setting for the speaker sound of Anne-regulation.
Syntax	:UTILity:UNReg {< Boolean > ON OFF}
Query Syntax	:UTILity:UNReg?
Parameter	ON or 1 Sets on the speaker sound of Anne-regulation. OFF or 0 Sets off the speaker sound of Anne-regulation.
Return parameter	Return the setting value of speaker sound of Anne-regulation, by the "{On Off}" string.
Example	:UTIL:UNR ON Sets on the speaker sound of Anne-regulation.
Query example	:UTIL:UNR? >On Return the setting value of speaker sound of Anne-regulation.

4-19.Interface Commands



4-19-1. :UTILity:BRATe

Description	Query and setting for the baud rate of RS-232C. Note: Command is only valid for interface setting of RS-232C
Syntax	:UTILity:BRATe {2400 4800 9600 19200 38400}
Query Syntax	:UTILity:BRATe?
Parameter	<NR1> Sets the baud rate.
Return parameter	<NR1> Return the baud rate.
Example	:UTIL:BRAT 38400 Sets the baud rate.
Query example	:UTIL:BRAT? >38400 Return the baud rate.

 →
 → 

4-19-2. :UTILity:INTERface

Description	Query and setting for the interface. Note: Command is only valid for RS-232Control and USB.
Syntax	:UTILity:INTERface {USB RS232}
Query Syntax	:UTILity:INTERface?
Parameter	Sets after the transmission, but require power cycle to enable the feature. USB Sets the USB interface. RS232 Sets the RS-232C interface.
Example	:UTIL:INT RS232 Sets the RS-232C interface.
Query example	:UTIL:INT? >RS232 Return the interface setting value.

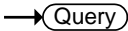
 →
 → 

4-19-3. :UTILity:PARity

Description	Query and setting for the parity bit of RS-232C interface. Note: Command is only valid for interface setting of RS-232C
Syntax	:UTILity:PARity { NONE ODD EVEN}
Query Syntax	:UTILity:PARity?
Parameter	NONE Sets no parity. ODD Sets the odd parity. EVEN Sets the even parity.
Return parameter	Return the parity bit of RS-232C interface, by the "{None Odd Even}" string.
Example	:UTIL:PAR NONE Sets no parity.
Query example	:UTIL:PAR? >None Return the setting of parity.

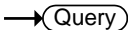
 →
 → 

4-19-4. :UTILity:SBIT

Description	Query and setting for the stop bit of the RS-232C interface. Note: Command is only valid for interface setting of RS232C
Syntax	:UTILity:SBIT {1 2}
Query Syntax	:UTILity:SBIT?

Parameter	<NR1>	Sets the stop bit.
Example	:UTIL:SBIT 1	Sets the stop bit.
Query example	:UTIL:SBIT? >1	Return the stop bit.

4-20.File Commands

4-20-1. :FACTory[:RECall]

Set →

Description	Sets factory defaults. Note) Interface will switch to as follows. Interface:RS-232C, Baud rate:38400, Stop bit:1, parity :None	
Syntax	:FACTory[:RECall]	
Example	:FACT	Sets factory defaults.

4-20-2. :MEMory:RECall

Set →

Description	Recall settings from the internal memory.	
Syntax	:MEMory:RECall <NR1>	
Parameter	<NR1>	Specify the internal memory number. (1 to 256)
Example	:MEM:REC 20	Recall setting internal memory 20.
Same function command	*RCL	

4-20-3. :MEMory:SAVE

Set →

Description	Save in the internal memory of the specified.	
Syntax	:MEMory:SAVE < NR1>	
Parameter	<NR1>	Specify the internal memory number. (1 to 256)
Example	:MEM:SAVE 20	Saves the current setting to internal memory 20.
Same function command	*SAV	

4-20-4. :PREset:RECall

Set →

Description	Recall settings from the preset memory.	
Syntax	:PREset:RECall <NR1>	
Parameter	<NR1>	Specify the preset memory number. (0 to 9)
Example	:PRE:REC 1 Recall setting preset memory 1.	

4-20-5. :PREset:SAVE

Set →

Description	Save to the preset memory of the specified.	
Syntax	:PREset:SAVE < NR1>	
Parameter	<NR1>	Specify the preset memory number. (0 to 9)
Example	:PRE:SAVE 1 Saves the setting value to preset memory 1.	

4-20-6. :SETup:RECall

Set →

Description	Recall settings from the setup data.	
Syntax	:SETup:RECall <NR1>	
Parameter	<NR1>	Specify the setup data number. (1 to 100)
Example	:SET:REC 1 Recall setting setup data 1.	

4-20-7. :SETup:SAVE

Set →

Description	Save to the setup data of the specified.	
Syntax	:SETup:SAVE < NR1>	
Parameter	<NR1>	Specify the setup data number. (1 to 100)
Example	:SET:SAVE 1 Saves the setting value to setup data 1.	

4-20-8. :USER[:DEFault]:RECall

Set →

Description	Recall the default settings for the user.	
Syntax	:USER[:DEFault]:RECall	

Example :USER:REC
Recall the default settings for the user.

4-20-9. :USER[:DEFault]:SAVE

Set →

Description Save to the default settings for the user.
Syntax :USER[:DEFault]:SAVE
Example :USER:SAVE
Save as user default settings the current settings value.

4-21. SCPI Status Commands

4-21-1. :SYSTem:ERRor

→ Query

Description Queries the error queue. The last error message is return. A maximum of 32 errors are stored in the error queue.
Query Syntax :SYSTem:ERRor?
Return parameter Returns the error queue, by the "<NR1>,<string>" string.
Query example :SYST:ERR?
>-113, "Undefined header"

4-21-2. :STATus:PRESet

Set →

Description Is the setting of the initial value for the Csummary status and the Questionable status and the Operation status. PTR (positive transition) filter is set, enable register and (negative transition) NTR filter is reset.

Initial value of Register / Filter	Setting
Csummary status enable	0x0000
Csummary status PTR (positive transition)	0x7FFF
Csummary status NTR (negative transition)	0x0000
Operation status enable	0x0000
Operation status PTR (positive transition)	0x7FFF
Operation status NTR (negative transition)	0x0000
Questionable status enable	0x0000
Questionable status PTR (positive transition)	0x7FFF
Questionable status NTR (negative transition)	0x0000

Syntax :STATus:PRESet

Example	:STAT:PRES It set the initial value for the Csummary status and the Questionable status and the Operation status.
---------	--

4-22.Csummary Status Commands

4-22-1. :STATus:CSUMmary:CONDition → Query

Description	Query the Condition register of Csummary.
Query Syntax	:STATus:CSUMmary:CONDition?
Return parameter	Return the Condition register of Csummary, by the "<NR1>" string.
Query example	:STAT:CSUM:COND? >1 Return the Condition register of Csummary.

Set →

4-22-2. :STATus:CSUMmary:ENABLE → Query

Description	Query and setting for the Event Enable register of Csummary.
Syntax	:STATus:CSUMmary:ENABLE <NR1>
Query Syntax	:STATus:CSUMmary:ENABLE?
Parameter	<NR1> Sets the Event Enable register of Csummary.
Example	:STAT:CSUM:ENAB 1 Sets the Event Enable register of Csummary.
Query example	:STAT:CSUM:ENAB? >1 Return the Event Enable register of Csummary.

4-22-3. :STATus:CSUMmary[:EVENT] → Query

Description	Query and setting for the Event register of Csummary.
Query Syntax	:STATus:CSUMmary[:EVENT]?
Return parameter	Return the Event register of Csummary, by the "<NR1>" string.
Query example	:STAT:CSUM? >1 Return the Event register of Csummary.

Set →
 → Query

4-22-4. :STATus:CSUMmary:NTRansition

Description	Query and setting for detection bit of Csummary status of changes of from positive to negative.
Syntax	:STATus:CSUMmary:NTRansition <NR1>
Query Syntax	:STATus:CSUMmary:NTRansition?
Parameter	<NR1> Sets the detection bit of Csummary status of changes from positive to negative.
Example	:STAT:CSUM:NTR 1 Sets the detection bit of Csummary status of changes from positive to negative.
Query example	:STAT:CSUM:NTR? >1 Return the detection bit of Csummary status of changes from positive to negative.

Set →
 → Query

4-22-5. :STATus:CSUMmary:PTRansition

Description	Query and setting for detection bit of Csummary status of changes of from negative to positive.
Syntax	:STATus:CSUMmary:PTRansition <NR1>
Query Syntax	:STATus:CSUMmary:PTRansition?
Parameter	<NR1> Sets the detection bit of Csummary status of changes from negative to positive.
Example	:STAT:CSUM:PTR 1 Sets the detection bit of Csummary status of changes from negative to positive.
Query example	:STAT:CSUM:PTR? >1 Return the detection bit of Csummary status of changes from negative to positive.

4-23. Operation Status Commands

4-23-1. :STATus:OPERation:CONDition

→ Query

Description	Query the Condition register of Operation.
Query Syntax	:STATus:OPERation:CONDition?

Return parameter	Return the Condition register of Operation, by the "<NR1>" string.
Query example	:STAT:OPER:COND? >1 Return the Condition register of Operation.

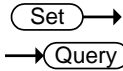

4-23-2. :STATus:OPERation:ENABLE

Description	Query and setting for the Event Enable register of Operation.
Syntax	:STATus:OPERation:ENABLE <NR1>
Query Syntax	:STATus:OPERation:ENABLE?
Parameter	<NR1> Sets the Event Enable register of Operation.
Example	:STAT:OPER:ENAB 1 Sets the Event Enable register of Operation.
Query example	:STAT:OPER:ENAB? >1 Return the Event Enable register of Operation.

4-23-3. :STATus:OPERation [:EVENT]

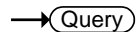

Description	Query and setting for the Event register of Operation.
Query Syntax	:STATus:OPERation[:EVENT]?
Return parameter	Return the Event register of Operation, by the "<NR1>" string.
Query example	:STAT:OPER? >1 Return the Event register of Operation.

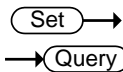

4-23-4. :STATus:OPERation:NTRansition

Description	Query and setting for detection bit of Operation status of changes of from positive to negative.
Syntax	:STATus OPERation:NTRansition <NR1>
Query Syntax	:STATus:OPERation:NTRansition?
Parameter	<NR1> Sets the detection bit of Operation status of changes from positive to negative.
Example	:STAT:OPER:NTR 1 Sets the detection bit of Operation status of changes from positive to negative.

Query example :STAT:OPER:NTR?
 >1
 Return the detection bit of Operation status of changes from positive to negative.

Set →

4-23-5. :STATus:OPERation:PTRansition

→ Query

Description Query and setting for detection bit of Operation status of changes of from negative to positive.

Syntax :STATus:OPERation:PTRansition <NR1>

Query Syntax :STATus OPERation:PTRansition?

Parameter <NR1> Sets the detection bit of Operation status of changes from negative to positive.

Example :STAT:OPER:PTR 1
 Sets the detection bit of Operation status of changes from negative to positive.

Query example :STAT:OPER:PTR?
 >1
 Return the detection bit of Operation status of changes from negative to positive.

4-24. Questionable Status Commands

4-24-1. :STATus:QUEStionable:CONDition

→ Query

Description Query the Condition register of Questionable.

Query Syntax :STATus:QUEStionable:CONDition?

Return Return the Condition register of Questionable, by the parameter "<NR1>" string.

Query example :STAT: QUES:COND?
 >1
 Return the Condition register of Questionable.

Set →

4-24-2. :STATus:QUEStionable:ENABLE

→ Query

Description Query and setting for the Event Enable register of Questionable.

Syntax :STATus:QUEStionable:ENABLE <NR1>

Query Syntax :STATus:QUEStionable:ENABLE?

Parameter <NR1> Sets the Event Enable register of Questionable.

Example :STAT:QUES:ENAB 1
 Sets the Event Enable register of Questionable.

Query example :STAT:QUES:ENAB?
 >1
 Return the Event Enable register of Questionable.

4-24-3. :STATus:QUESTionable [:EVENT] → Query

Description	Query and setting for the Event register of Questionable.
Query Syntax	:STATus:QUESTionable[:EVENT]?
Return parameter	Return the Event register of Questionable, by the "<NR1>" string.
Query example	:STAT:QUES? >1 Return the Event register of Questionable.

Set →

4-24-4. :STATus:QUESTionable:NTRansition → Query

Description	Query and setting for detection bit of Questionable status of changes of from positive to negative.
Syntax	:STATus:QUESTionable:NTRansition <NR1>
Query Syntax	:STATus:QUESTionable:NTRansition?
Parameter	<NR1> Sets the detection bit of Questionable status of changes from positive to negative.
Example	:STAT:QUES:NTR 1 Sets the detection bit of Questionable status of changes from positive to negative.
Query example	:STAT:QUES:NTR? >1 Return the detection bit of Questionable status of changes from positive to negative.

Set →

4-24-5. :STATus:QUESTionable:PTRansition → Query

Description	Query and setting for detection bit of Questionable status of changes of from negative to positive.
Syntax	:STATus:QUESTionable:PTRansition <NR1>
Query Syntax	:STATus:QUESTionable:PTRansition?
Parameter	<NR1> Sets the detection bit of Questionable status of changes from negative to positive.

Example	:STAT:QUES:PTR 1 Sets the detection bit of Questionable status of changes from negative to positive.
Query example	:STAT:QUES:PTR? >1 Return the detection bit of Questionable status of changes from negative to positive.

5. Status Register Overview

This chapter explains in detail how the Status registers are used and how to configure them.

It will also be able to create an effective program by understand the Status register.

5-1. Introduction to the Status Registers

Overview The status registers are used to know the status of this unit. It is maintain the status of the protection conditions, operation conditions and unit errors.

The LSG Series have a number of register groups.

- Csummary Status Register Group
- Operation Status Register Group
- Questionable Status Register Group
- Standard Event Status Register Group
- Status Register Group

5-2. Configuration in the Status register

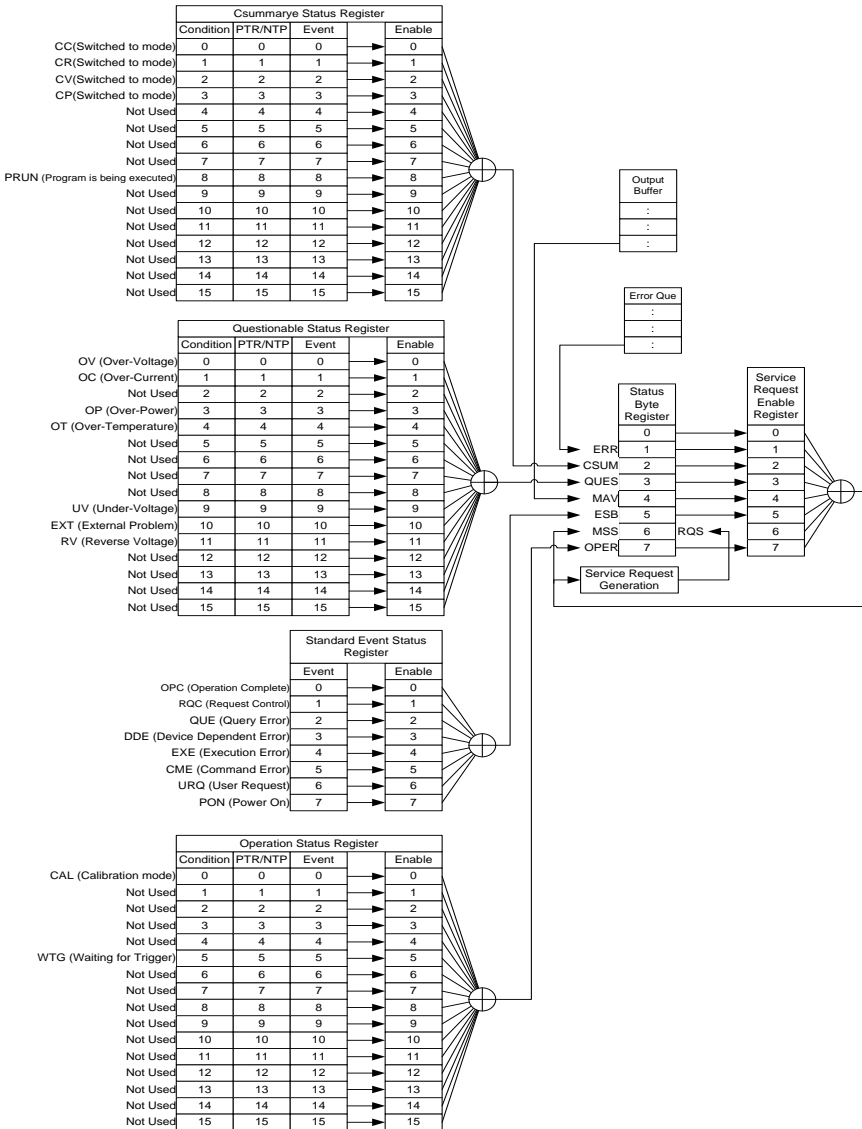

5-3.Csummary Status Register Group

Overview Csummary Status register group, you can check the operating status of the load mode and sequence or program mode.

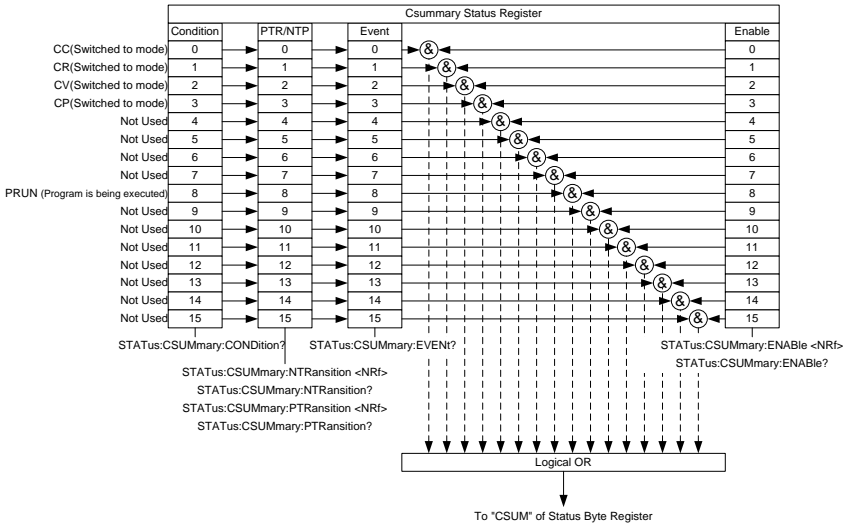

Bit Summary	Bit name	Event	Bit #	Bit Weight
	CC	Indicate the Constant Current mode setting.	0	1
	CR	Indicate the Constant Resistance mode setting.	1	2
	CV	Indicate the Constant Voltage mode setting.	2	4
	CP	Indicate the Constant Power mode setting.	3	8
	PRUN	Indicate the operation mode of Sequence or Program.	8	256

Condition Register Csummary Status Condition register can be read the current state of the load mode and program mode or sequence operation mode.

PTR/NTR Filter	The PTR/NTR (Positive/Negative transition) register determines the type of transition conditions that will set the corresponding bit in the Event Registers. Use the Positive transition filter to view events that change from false to positive, and use the negative transition filter to view events that change from positive to negative.
	Positive Transition 0→1 Negative Transition 1→0
Event Register	The PTR/NTR Register will dictate the type of transition conditions will set the corresponding bits in the Event Register. If the Event Register is read, it will be cleared to 0.
Enable Register	The Enable register determines which Events in the Event Register will be used to set the CSUM bit in the Status Byte Register.

5-4.Operation Status Register Group

Overview Operation Status register group, you can check the operating status of the Trigger wait or the Calibration mode.

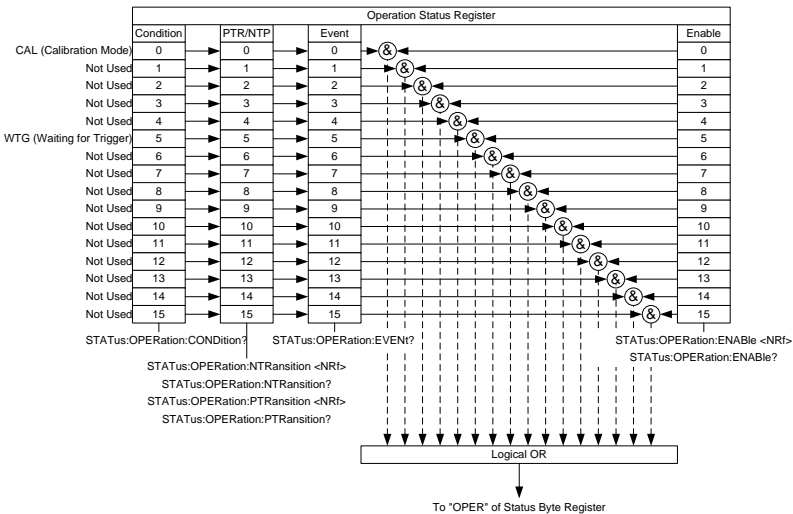

Bit Summary	Bit name	Event	Bit #	Bit Weight
	CAL	Indicate the Calibration mode.	0	1
	WTG	Indicate the Trigger wait.	5	32

Condition Register Operation Status Condition register can be read by the current state of the Trigger waiting and Calibration mode.

PTR/NTR Filter The PTR/NTR (Positive/Negative transition) register determines the type of transition conditions that will set the corresponding bit in the Event Registers. Use the Positive transition filter to view events that change from false to positive, and use the negative transition filter to view events that change from positive to negative.

Positive Transition	0→1
Negative Transition	1→0

Event Register The PTR/NTR Register will dictate the type of transition conditions will set the corresponding bits in the Event Register. If the Event Register is read, it will be cleared to 0.

Enable Register The Enable register determines which Events in the Event Register will be used to set the OPER bit in the Status Byte Register.

5-5.Questionable Status Register Group

Overview Questionable Status register group, you can check the operating status of the protection function.

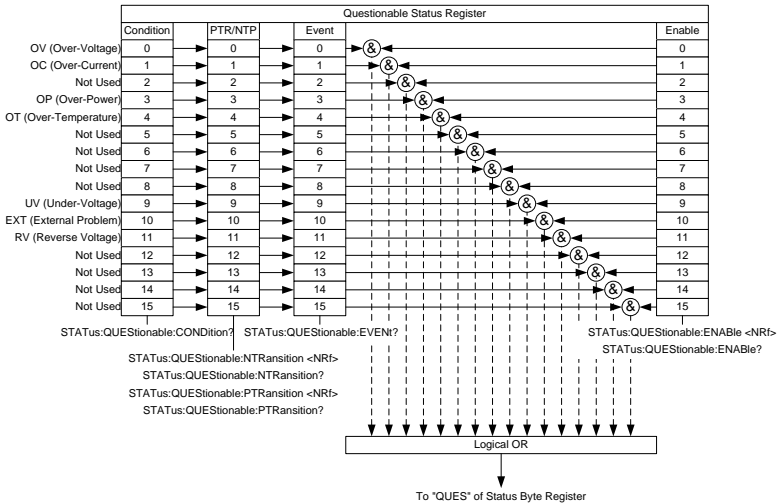

Bit Summary	Bit name	Event	Bit #	Bit Weight
	OV	Indicate the Over-Voltage condition.	0	1
	OC	Indicate the Over-Current condition.	1	2
	OP	Indicate the Over-Power condition.	3	8
	OT	Indicate the Over-Temperature condition.	4	16

UV	Indicate the Under-Voltage condition.	9	512
EXT	Indicate the abnormality state of the external control.	10	1024
RV	Indicate the reverse connection state.	11	2048

Condition Register Questionable Status Condition register can be read the current state of the protection function.

PTR/NTR Filter The PTR/NTR (Positive/Negative transition) register determines the type of transition conditions that will set the corresponding bit in the Event Registers. Use the Positive transition filter to view events that change from false to positive, and use the negative transition filter to view events that change from positive to negative.

Positive Transition	0→1
Negative Transition	1→0

Event Register The PTR/NTR Register will dictate the type of transition conditions will set the corresponding bits in the Event Register. If the Event Register is read, it will be cleared to 0.

Enable Register The Enable register determines which Events in the Event Register will be used to set the QUES bit in the Status Byte Register.

5-6. Standard Event Status Register Group

Overview Standard Event Status register group indicates whether an error occurred. Bit in the event register is set by the error event queue.

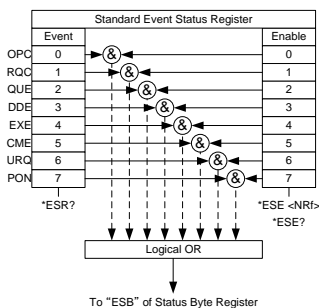

Bit Summary	Bit name	Event	Bit #	Bit Weight
	OPC	Operation complete The OCP bit is set when all selected pending operations are complete. This bit is set in response to the *OPC command.	0	1
	RQC	Request control	1	2
	QUE	Query Error The Query Error bit is set in response to an error reading the Output Queue. This can be caused by trying to read the Output Queue when there is no data present.	2	4
	DDE	Device Dependent Error Device specific error.	3	8
	EXE	Execution Error The EXE bit indicates an execution error due to one of the following: illegal command parameter, parameter out of range, invalid parameter, the command didn't execute due to an overriding operation condition.	4	16
	CME	Command Error The CME bit is set when a syntax error has occurred. The CME bit can also be set when a <GET> command is received within a program message.	5	32
	URQ	User Request	6	64
	PON	Power On Indicates the power is turned on.	7	128

Event Register Any bits set in the event register indicate that an error has occurred. Reading the Event register will reset the register to 0.

Enable Register The Enable register determines which Events in the Event Register will be used to set the ESB bit in the Status Byte Register.

5-7. Status Register Group

Overview The Status Byte register groups, you can check the status of the event in the status register of all. You can read the status byte register in "* STB?" Query command.

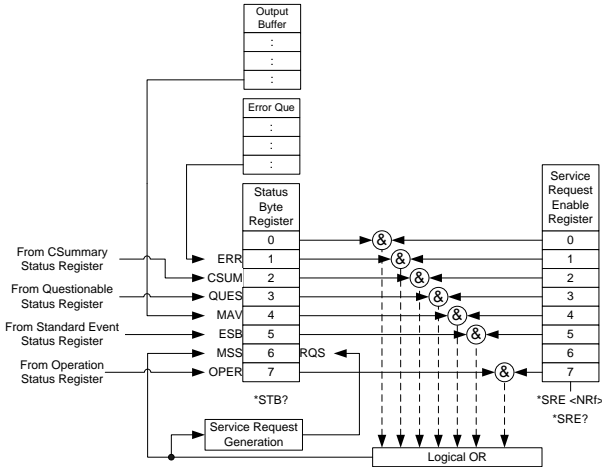

Bit Summary	Bit name	Event	Bit #	Bit Weight
	ERR	Error Event/Queue If data is present in the Error queue, the ERR bit will be set.	1	2
	CSUM	Csummary Status Register The summary bit for the Csummary Status Register group.	2	4
	QUES	Questionable Status Register The summary bit for the Questionable Status Register group.	3	8
	MAV	Message Available This is set when there is data in the Output Queue waiting to be read.	4	16
	ESB	Event Summary Bit. The ESB is the summary bit for the Standard Event Status Register group.	5	32
	MSS /RQS	The MSS Bit is the summary of the Status Byte Register and Service Request register (bits 1-5, 7). This will be set to 1.	6	64

	OPER	Operation Status Register OPER bit is the summary bit for the Operation Status Register Group.	7	128
--	------	--	---	-----

Status Byte Register Any bits set in the Status byte register acts as a summary register for all the four other status registers and indicates if there is a service request, an error in the Error Queue or data in the Output Queue. Reading the Status Byte register will reset the register to 0.

Service Request Enable Register Service Request Enable register specifies the bits in the Status Byte register for setting the MSS / RQS bit in the Status Byte register.
Also, MSS bit, can see in the "*STB?" Query command.
RQS bit is used to RQS bit of the GP-IB interface managed by the service request generator a bit of MSS. RQS bit is initialized after reading.

6.Appendix

6-1.ERROR MESSAGE

The following error messages may be encountered when reading the error queue.

Error Code and string	Description
Command Errors	
0 NoError	No error
-100 Command Error	This is the generic syntax error for devices that cannot detect more specific errors.
-101 Invalid character	A syntactic element contains a character which is invalid for that type.
-102 Syntax error	An unrecognized command or data type was encountered.
-103 Invalid separator	The parser was expecting a separator and encountered an illegal character.
-104 Data type error	The parser recognized a data element different than the one allowed.
-105 GET not allowed	A Group Execute Trigger was received within a program message.
-108 Parameter not allowed	More parameters were received than expected for the header.
-109 Missing parameter	Fewer parameters were received than required for the header.
-110 Command header error	An error was detected in the header.
-111 Header separator error	A character which is not a legal header separator was encountered while parsing the header.
-112 Program mnemonic too long	The header contains more than twelve characters.
-113 Undefined header	The header is syntactically correct, but it is undefined for this specific device.
-114 Header suffix out of range	The value of a numeric suffix attached to a program mnemonic.
-115 Unexpected number of parameters	The number of parameters received does not correspond to the number of parameters expected.
-120 Numeric data error	This error is generated when parsing a data element which appears to be numeric, including the nondecimal numeric types.
-121 Invalid character in number	An invalid character for the data type being parsed was encountered.
-123 Exponent too large	The magnitude of the exponent was larger than 32000.
-124 Too many digits	The mantissa of a decimal numeric data element contained more than 255 digits excluding leading zeros.
-128 Numeric data not allowed	A legal numeric data element was received, but the device does not accept one in this position for the header
-130 Suffix error	This error, as well as errors -131 through -139, are generated when parsing a suffix.
-131 Invalid suffix	The suffix does not follow the syntax described in IEEE 488.2 or the suffix is inappropriate for this device.
-134 Suffix too long	The suffix contained more than 12 characters.
-138 Suffix not allowed	A suffix was encountered after a numeric element which does not allow suffixes.

-140 Character data error	This error is generated when parsing a character data element.
-141 Invalid character data	Either the character data element contains an invalid character or the particular element received is not valid for the header.
-144 Character data too long	The character data element contains more than twelve characters
-148 Character data not allowed	A legal character data element was encountered where prohibited by the device.
-150 String data error	This error is generated when parsing a string data element.
-151 Invalid string data	A string data element was expected, but was invalid for some reason.
-158 String data not allowed	A string data element was encountered but was not allowed by the device at this point in parsing.
-160 Block data error	This error is generated when parsing a block data element.
-161 Invalid block data	A block data element was expected, but was invalid for some reason.
-168 Block data not allowed	A legal block data element was encountered but was not allowed by the device at this point in parsing.
-170 Expression error	This error is generated when parsing an expression data element.
-171 Invalid expression	The expression data element was invalid.
-178 Expression data not allowed	A legal expression data was encountered but was not allowed by the device at this point in parsing.
-180 Macro error	This error is generated when defining a macro or executing a macro.
-181 Invalid outside macro definition	Indicates that a macro parameter placeholder (\$<number) was encountered outside of a macro definition.
-183 Invalid inside macro definition	Indicates that the program message unit sequence, sent with a *DDT or *DMC command, is syntactically invalid.
-184 Macro parameter error	Indicates that a command inside the macro definition had the wrong number or type of parameters.

Execution Errors

-200 Execution error	This is the generic syntax error for devices that cannot detect more specific errors. This code indicates only that an Execution Error as defined in IEEE 488.2 has occurred.
-201 Invalid while in local	Indicates that a command is not executable while the device is in local due to a hard local control
-202 Settings lost due to rtl	Indicates that a setting associated with a hard local control was lost when the device changed to LOCS from REMS or to LWLS from RWLS.
-203 Command protected	Indicates that a legal password-protected program command or query could not be executed because the command was disabled.
-210 Trigger error	
-211 Trigger ignored	Indicates that a GET, *TRG, or triggering signal was received and recognized by the device but was ignored because of device timing considerations.
-212 Arm ignored	Indicates that an arming signal was received and recognized by the device but was ignored.

-213 Init ignored	Indicates that a request for a measurement initiation was ignored as another measurement was already in progress.
-214 Trigger deadlock	Indicates that the trigger source for the initiation of a measurement is set to GET and subsequent measurement query is received. The measurement cannot be started until a GET is received, but the GET would cause an INTERRUPTED error.
-215 Arm deadlock	Indicates that the arm source for the initiation of a measurement is set to GET and subsequent measurement query is received. The measurement cannot be started until a GET is received, but the GET would cause an INTERRUPTED error.
-220 Parameter error	Indicates that a program data element related error occurred.
-221 Settings conflict	Indicates that a legal program data element was parsed but could not be executed due to the current device state.
-222 Data out of range	Indicates that a legal program data element was parsed but could not be executed because the interpreted value was outside the legal range as defined by the device.
-223 Too much data	Indicates that a legal program data element of block, expression, or string type was received that contained more data than the device could handle due to memory or related device-specific requirements.
-224 Illegal parameter value	Used where an exact value, from a list of possibilities, was expected.
-225 Out of memory.	The device has insufficient memory to perform the requested operation.
-226 Lists not same length.	Attempted to use LIST structure having individual LIST's of unequal lengths.
-230 Data corrupt or stale	Possibly invalid data; new reading started but not completed since last access.
-231 Data questionable	Indicates that measurement accuracy is suspect.
-232 Invalid format	Indicates that a legal program data element was parsed but could not be executed because the data format or structure is inappropriate.
-233 Invalid version	Indicates that a legal program data element was parsed but could not be executed because the version of the data is incorrect to the device.
-240 Hardware error	Indicates that a legal program command or query could not be executed because of a hardware problem in the device.
-241 Hardware missing	Indicates that a legal program command or query could not be executed because of missing device hardware.
-250 Mass storage error	Indicates that a mass storage error occurred.
-251 Missing mass storage	Indicates that a legal program command or query could not be executed because of missing mass storage.
-252 Missing media	Indicates that a legal program command or query could not be executed because of a missing media.
-253 Corrupt media	Indicates that a legal program command or query could not be executed because of corrupt media.
-254 Media full	Indicates that a legal program command or query could not be executed because the media was full.
-255 Directory full	Indicates that a legal program command or query could not be executed because the media directory was full.

-256 File name not found	Indicates that a legal program command or query could not be executed because the file name on the device media was not found.
-257 File name error	Indicates that a legal program command or query could not be executed because the file name on the device media was in error.
-258 Media protected	Indicates that a legal program command or query could not be executed because the media was protected.
-260 Expression error	Indicates that a expression program data element related error occurred.
-261 Math error in expression	Indicates that a syntactically legal expression program data element could not be executed due to a math error.
-270 Macro error	Indicates that a macro-related execution error occurred.
-271 Macro syntax error	Indicates that that a syntactically legal macro program data sequence, according to IEEE 488.2 could not be executed due to a syntax error within the macro definition.
-272 Macro execution error	Indicates that a syntactically legal macro program data sequence could not be executed due to some error in the macro definition.
-273 Illegal macro label	Indicates that the macro label defined in the *DMC command was a legal string syntax, but could not be accepted by the device.
-274 Macro parameter error	Indicates that the macro definition improperly used a macro parameter placeholder.
-275 Macro definition too long	Indicates that a syntactically legal macro program data sequence could not be executed because the string or block contents were too long for the device to handle.
-276 Macro recursion error	Indicates that a syntactically legal macro program data sequence could not be executed because the device found it to be recursive.
-277 Macro redefinition not allowed	Indicates that a syntactically legal macro label in the *DMC command could not be executed because the macro label was already defined.
-278 Macro header not found	Indicates that a syntactically legal macro label in the *GMC? query could not be executed because the header was not previously defined.
-280 Program error	Indicates that a downloaded program-related execution error occurred.
-281 Cannot create program	Indicates that an attempt to create a program was unsuccessful. A reason for the failure might include not enough memory.
-282 Illegal program name	The name used to reference a program was invalid.
-283 Illegal variable name	An attempt was made to reference a nonexistent variable in a program.
-284 Program currently running	Certain operations dealing with programs may be illegal while the program is running.
-285 Program syntax error	Indicates that a syntax error appears in a downloaded program.
-286 Program runtime error	
-290 Memory use error	Indicates that a user request has directly or indirectly caused an error related to memory or <data_handle>s, this is not the same as "bad" memory.
-291 Out of memory	

-292 Referenced name does not exist	
-293 Referenced name already exists	
-294 Incompatible type	Indicates that the type or structure of a memory item is inadequate.
Device Specific Errors	
-300 Device-specific error	This is the generic device-dependent error for devices that cannot detect more specific errors.
-310 System error	Indicates that some error, termed "system error" by the device, has occurred.
-311 Memory error	Indicates some physical fault in the device's memory, such as parity error.
-312 PUD memory lost	Indicates that the protected user data saved by the *PUD command has been lost.
-313 Calibration memory lost	Indicates that nonvolatile calibration data used by the *CAL? command has been lost.
-314 Save/recall memory lost	Indicates that the nonvolatile data saved by the *SAV? command has been lost.
-315 Configuration memory lost	Indicates that nonvolatile configuration data saved by the device has been lost.
-320 Storage fault	[Indicates that the firmware detected a fault when using data storage. This error is not an indication of physical damage or failure of any mass storage element.
-321 Out of memory	An internal operation needed more memory than was available.
-330 Self-test failed	fail of Self Test.
-340 Calibration failed	Fail of Calibration.
-350 Queue overflow	A specific code entered into the queue in lieu of the code that caused the error. This code indicates that there is no room in the queue and an error occurred but was not recorded.
-360 Communication error	This is the generic communication error.
-361 Parity error in program message	Parity bit not correct when data received.
-362 Framing error in program message	A stop bit was not detected when data was received.
-363 Input buffer overrun	Software or hardware input buffer on serial port overflows with data caused by improper or nonexistent pacing.
-365 Time out error	This is a generic device-dependent error.
Query Errors	
-400 Query error	This is the generic query error.
-410 Query INTERRUPTED	Indicates that a condition causing an INTERRUPTED Query error occurred.
-420 Query UNTERMINATED	Indicates that a condition causing an UNTERMINATED Query error occurred.
-430 Query DEADLOCKED	Indicates that a condition causing a DEADLOCKED Query error occurred.
-440 Query UNTERMINATED after indefinite response	Indicates that a query was received in the same program message after a query requesting an indefinite response was executed
Power On Event Commands	
-500 Power on	The instrument has detected an off to on transition in its power supply.
User Request Event	

-600 User request

The instrument has detected the activation of a user request local control.

Request Control Event

-700 Request control

The instrument requested to become the active IEEE 488.1 controller-in-charge.

Operation Complete Event

-800 Operation complete

The instrument has completed all selected pending operations in accordance with the IEEE 488.2 synchronization protocol.

6-2.Trigger State

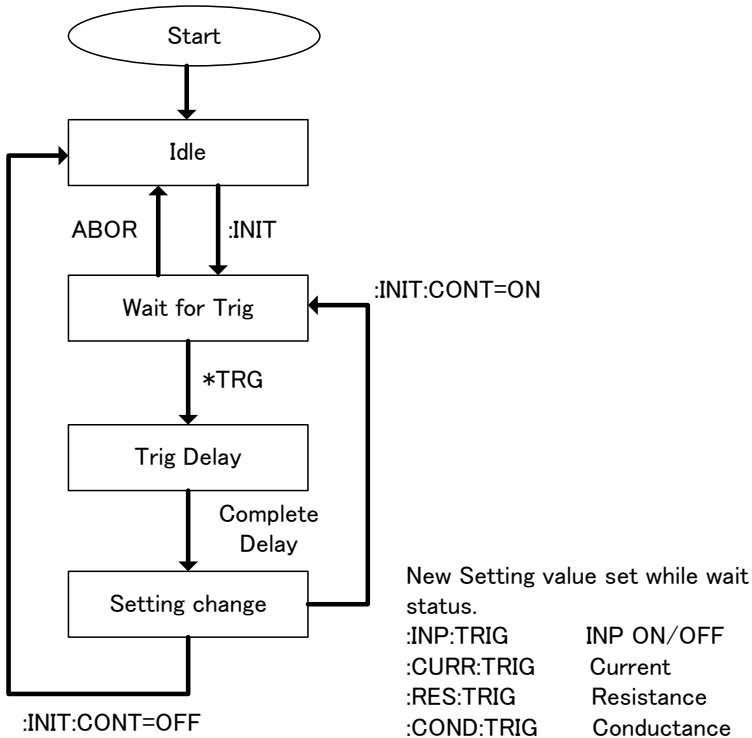

6-3.Change History

B71-0428-01(Ver1.01) to B71-0428-11(Ver1.02)

Change of parameters(Conductance[mho] to Resistance[ohm])

:RESistance[:VA]
:RESistance[:VA]:TRIGgered
:RESistance:VB
:RESistance:L1
:RESistance:L2
:RESistance:SET

Add Commands

:CONDuctance[:VA]
:CONDuctance[:VA]:TRIGgered
:CONDuctance:VB
:CONDuctance:L1
:CONDuctance:L2
:CONDuctance:SET



TEXIO TECHNOLOGY CORPORATION

7F Towa Fudosan Shin Yokohama Bldg., 2-18-13, Shin Yokohama, Kohoku-ku,
Yokohama, Kanagawa, 222-0033, Japan.

<http://www.texio.co.jp/>
