

PROGRAMMING MANUAL

ELECTRONIC LOAD LSG SERIES

LSG-175H LSG-350H LSG-1050H
LSG-175 LSG-350 LSG-1050



■ **About a trademark, a registered trademark**

A company name and the brand name mentioned in this instruction manual are the trademark or the registered trademark of each company or group in each country and region.

■ **About this instruction manual**

When copying the part or all of contents of this instruction manual, seek the copyright holder.

In addition, the specifications of the product and the contents of this instruction manual are subject to change without notice for improvement. Please check to our website for the latest version.

CONTENTS

1. INTERFACE OVERVIEW	1
1-1. Front Panel Overview	1
1-2. Rear Panel Overview	1
2. INTERFACE Configure	2
2-1. Configuring the USB Interface	2
2-2. Configuring the RS-232C Interface	2
2-3. Configuring the GP-IB Interface	3
2-4. RS-232C/USB Remote Control Function Check	4
2-5. Using RealTerm to Establish a Remote Connection	5
2-6. GP-IB Function Check	7
3. COMMAND OVERVIEW	9
3-1. Command Syntax	9
4. COMMAND DETAILS	12
4-1. Common Commands	12
4-1-1. *CLS	12
4-1-2. *ESE	12
4-1-3. *ESR	13
4-1-4. *IDN	13
4-1-5. *OPC	13
4-1-6. *RCL	14
4-1-7. *RST	14
4-1-8. *SAV	14
4-1-9. *SRE	15
4-1-10. *STB	15
4-1-11. *TRG	16
4-1-12. *TST	16
4-2. Trigger Commands	17
4-2-1. :ABORt	18
4-2-2. :INPut[:STATe]:TRIGgered	18
4-2-3. :INITiate[:IMMediate]	18
4-2-4. :INITiate:CONTinuous	19
4-2-5. :TRIGger[:DELay]:TIME	19
4-2-6. :TRIGger[:PULSe]:WIDTh	20
4-3. Input Commands	21
4-3-1. :INPut	21
4-3-2. :INPut:MODE	21
4-3-3. [:INPut]:SHORT	22
4-4. Measurement Commands	23
4-4-1. :MEASure:CURRent	23
4-4-2. :MEASure:ETIME	23
4-4-3. :MEASure:POWER	23
4-4-4. :MEASure:VOLTage	23
4-5. Fetch Commands	24

4-5-1. :FETCh:CURRent	24
4-5-2. :FETCh:POWer	24
4-5-3. :FETCh:VOLTage	24
4-6. Configure Subsystem Commands	25
4-6-1. [:CONFigure]:OCP	25
4-6-2. [:CONFigure]:OPP	26
4-6-3. [:CONFigure]:UVP	26
4-6-4. [:CONFigure]:UVP:TIME	27
4-6-5. [:CONFigure]:OVP	27
4-6-6. [:CONFigure]:SStart	28
4-6-7. [:CONFigure]:VON	28
4-6-8. [:CONFigure]:VDElay	29
4-6-9. :CONFigure:RESPOse	29
4-6-10. [:CONFigure]:CNTime	30
4-6-11. [:CONFigure]:COTime	30
4-6-12. [:CONFigure]:CRUnit	31
4-6-13. :CONFigure:DYNamic	31
4-6-14. :CONFigure:MEMory	32
4-6-15. :CONFigure:SHORt	32
4-6-16. :CONFigure:SHORt:SAFety	33
4-6-17. :CONFigure:SHORt:FUNCTion	33
4-6-18. [:CONFigure]:GNG:MODE	34
4-6-19. [:CONFigure]:GNG:H	34
4-6-20. [:CONFigure]:GNG:L	35
4-6-21. [:CONFigure]:GNG:C	35
4-6-22. [:CONFigure]:GNG:DTIME	36
4-6-23. [:CONFigure]:GNG:SPECTest	36
4-6-24. [:CONFigure]:GNG[:PASS]	37
4-7. Parallel Commands	38
4-7-1. [:CONFigure]:PARAllel	38
4-8. Step Commands	39
4-8-1. :CONFigure:STATus	39
4-8-2. [:CONFigure]:STEP:CC	39
4-8-3. [:CONFigure]:STEP:CCH	40
4-8-4. [:CONFigure]:STEP:CCM	40
4-8-5. [:CONFigure]:STEP:CCL	41
4-8-6. [:CONFigure]:STEP:CR	41
4-8-7. [:CONFigure]:STEP:CRH	42
4-8-8. [:CONFigure]:STEP:CRM	42
4-8-9. [:CONFigure]:STEP:CRL	43
4-8-10. [:CONFigure]:STEP:CV	43
4-8-11. [:CONFigure]:STEP:CVH	44
4-8-12. [:CONFigure]:STEP:CVL	44
4-8-13. [:CONFigure]:STEP:CP	45
4-8-14. [:CONFigure]:STEP:CPH	45
4-8-15. [:CONFigure]:STEP:CPM	46
4-8-16. [:CONFigure]:STEP:CPL	46
4-9. External Control Commands	47

4-9-1. [:CONFigure]:EXTErnal[:CONTRol].....	47
4-9-2. [:CONFigure]:EXTErnal:CV	47
4-9-3. [:CONFigure]:EXTErnal:LOADonin	48
4-10. Mode Subsystem Commands	49
4-10-1. :MODE	49
4-10-2. [:MODE]:CRANge	49
4-10-3. [:MODE]:VRANge	50
4-10-4. [:MODE]:RESPonse.....	50
4-10-5. [:MODE]:DYNamic	51
4-11. Current Subsystem Commands.....	52
4-11-1. :CURRent[:VA].....	52
4-11-2. :CURRent[:VA]:TRIGgered	52
4-11-3. :CURRent:VB.....	53
4-11-4. :CURRent:SRATe	53
4-11-5. :CURRent:L1.....	54
4-11-6. :CURRent:L2.....	54
4-11-7. :CURRent:SET.....	55
4-11-8. :CURRent:LEVel	55
4-11-9. :CURRent:RISE	56
4-11-10. :CURRent:FALL	56
4-11-11. :CURRent:T1	57
4-11-12. :CURRent:T2	57
4-11-13. :CURRent:FREQuency	58
4-11-14. :CURRent:DUTY.....	58
4-11-15. :CURRent:RECall	59
4-12. Resistance Subsystem Commands	60
4-12-1. :RESistance[:VA]	60
4-12-2. :RESistance[:VA]:TRIGgered.....	60
4-12-3. :RESistance:VB	61
4-12-4. :RESistance:SRATe.....	61
4-12-5. :RESistance:L1	62
4-12-6. :RESistance:L2	62
4-12-7. :RESistance:SET	63
4-12-8. :RESistance:LEVel.....	63
4-12-9. :RESistance:RISE	64
4-12-10. :RESistance:FALL.....	64
4-12-11. :RESistance:T1	65
4-12-12. :RESistance:T2.....	65
4-12-13. :RESistance:FREQuency.....	66
4-12-14. :RESistance:DUTY	66
4-12-15. :RESistance:RECall	67
4-12-16. :CONDuctance[:VA].....	67
4-12-17. :CONDuctance[:VA]:TRIGgered	68
4-12-18. :CONDuctance:VB	68
4-12-19. :CONDuctance:L1	69
4-12-20. :CONDuctance:L2.....	69
4-12-21. :CONDuctance:SET.....	70
4-12-22. :CONDuctance:RECall.....	70

4-13. Voltage Subsystem Commands	71
4-13-1. :VOLTage[:VA].....	71
4-13-2. :VOLTage:VB.....	71
4-13-3. :VOLTage:RECall	72
4-14. Power Subsystem Commands	73
4-14-1. :POWer[:VA]	73
4-14-2. :POWer:VB	73
4-14-3. :POWer:L1	74
4-14-4. :POWer:L2	74
4-14-5. :POWer:SET	75
4-14-6. :POWer:LEVel.....	75
4-14-7. :POWer:T1	76
4-14-8. :POWer:T2.....	76
4-14-9. :POWer:FREQuency.....	77
4-14-10. :POWer:DUTY	77
4-14-11. :POWer:RECall	78
4-15. Program Commands.....	79
4-15-1. :FUNCTion[:COMPLet][:RING]:TIME	79
4-15-2. :PROGram:STATe	80
4-15-3. :PROGram	81
4-15-4. :PROGram[:RECall]:DEFault	82
4-15-5. :PROGram:STARt.....	82
4-15-6. :PROGram:STEP	82
4-15-7. :PROGram:MEMory	83
4-15-8. :PROGram:RUN	83
4-15-9. :PROGram:ONTime.....	84
4-15-10. :PROGram:OFFTime	84
4-15-11. :PROGram:PFTIME.....	85
4-15-12. :PROGram:STIME.....	85
4-15-13. [:PROGram]:CHAI:n:STARt	86
4-15-14. [:PROGram]:CHAI:n	86
4-15-15. [:PROGram]:CHAI:n:P2P	87
4-15-16. [:PROGram]:CHAI:n[:RECall]:DEFault.....	87
4-15-17. :PROGram:SAVE.....	87
4-16. Normal sequence Commands	88
4-16-1. :NSEQuence:STATe	88
4-16-2. :NSEQuence	89
4-16-3. :NSEQuence:STARt	91
4-16-4. :NSEQuence:NUMBer	91
4-16-5. :NSEQuence:MEMO	92
4-16-6. :NSEQuence:MODE	92
4-16-7. :NSEQuence:RANGe.....	93
4-16-8. :NSEQuence:LOOP	93
4-16-9. :NSEQuence:LLOAD	94
4-16-10. :NSEQuence:LAST	94
4-16-11. :NSEQuence:CHAI:n.....	95
4-16-12. :NSEQuence:EDIT	96
4-16-13. :NSEQuence:EDIT:POINt.....	97

4-16-14. :NSEquence:EDIT:END	97
4-16-15. :NSEquence[:DELet]:ALL.....	97
4-16-16. :NSEquence:SAVE	98
4-16-17. :NSEquence:COTime.....	98
4-17. Fast sequence Commands	99
4-17-1. :FSEquence:STATe	99
4-17-2. :FSEquence	100
4-17-3. :FSEquence:MEMO	102
4-17-4. :FSEquence:MODE.....	102
4-17-5. :FSEquence:RANGE	103
4-17-6. :FSEquence:LOOP	103
4-17-7. :FSEquence:TBASe	104
4-17-8. :FSEquence:LLOAD.....	104
4-17-9. :FSEquence:LAST	105
4-17-10. :FSEquence:RPTStep	105
4-17-11. :FSEquence:EDIT	106
4-17-12. :FSEquence:EDIT:POINT.....	106
4-17-13. :FSEquence:EDIT:END.....	107
4-17-14. :FSEquence[:DELet]:ALL	107
4-17-15. :FSEquence[:EDIT]:FILL.....	107
4-17-16. :FSEquence:SAVE	108
4-18. OCP Test Commands	109
4-18-1. :OCP:STATe	109
4-18-2. :OCP:EDIT[:CHANnel].....	110
4-18-3. :OCP[:CHANnel]:NUMBER	111
4-18-4. :OCP:MEMO	111
4-18-5. :OCP[:CHANnel]:RANGE	112
4-18-6. :OCP[:CHANnel]:START.....	112
4-18-7. :OCP[:CHANnel]:END.....	113
4-18-8. :OCP[:CHANnel]:STEP:CURRent.....	113
4-18-9. :OCP[:CHANnel]:STEP:TIME	114
4-18-10. :OCP[:CHANnel]:DElay	114
4-18-11. :OCP[:CHANnel]:TRIGger.....	115
4-18-12. :OCP[:CHANnel]:LAST	115
4-18-13. :OCP:CHANnel:STATus	116
4-18-14. :OCP:RESult.....	116
4-18-15. :OCP:RUN	116
4-19. OPP Test Commands	117
4-19-1. :OPP:STATe	117
4-19-2. :OPP:EDIT[:CHANnel].....	118
4-19-3. :OPP[:CHANnel]:NUMBER.....	119
4-19-4. :OPP:MEMO	119
4-19-5. :OPP[:CHANnel]:RANGE	120
4-19-6. :OPP[:CHANnel]:START.....	120
4-19-7. :OPP[:CHANnel]:END.....	121
4-19-8. :OPP[:CHANnel]:STEP:WATT	121
4-19-9. :OCP[:CHANnel]:STEP:TIME	122
4-19-10. :OPP[:CHANnel]:DElay.....	122

4-19-11. :OPP[:CHANnel]:TRIGger.....	123
4-19-12. :OPP[:CHANnel]:LAST	123
4-19-13. :OPP:CHANnel:STATus	124
4-19-14. :OPP:RESult	124
4-19-15. :OCP:RUN	124
4-20. BATT Test Commands	125
4-20-1. :BATTery:STATE.....	125
4-20-2. :BATTery:EDIT.....	126
4-20-3. :BATTery [:CHANnel]:NUMBer	127
4-20-4. :BATTery:MEMO.....	127
4-20-5. :BATTery:MODE.....	128
4-20-6. :BATTery:RANGe	128
4-20-7. :BATTery:VALue.....	129
4-20-8. :BATTery:RISE	129
4-20-9. :BATTery:FALL.....	130
4-20-10. :BATTery:STOP:VOLTage.....	130
4-20-11. :BATTery:STOP:TIME	131
4-20-12. :BATTery:STOP:AH.....	131
4-20-13. :BATTery:DATalog:TIMer.....	132
4-20-14. :BATTery:CHANnel:STATus.....	132
4-20-15. :BATTery:RESult.....	133
4-20-16. :BATTery:RUN	133
4-21. Utility Commands	134
4-21-1. :UTILity:SYSTem	134
4-21-2. :UTILity:LOAD.....	134
4-21-3. :UTILity:LOAD:MODE	135
4-21-4. :UTILity:LOAD:RANGe	135
4-21-5. :UTILity:TIME	136
4-21-6. :UTILity:KNOB	136
4-21-7. :UTILity:SPEAker.....	137
4-21-8. :UTILity:ALARm	137
4-21-9. :UTILity:UNReg.....	138
4-21-10. :UTILity:GNG	138
4-21-11. :UTILity:CONTRast	139
4-21-12. :UTILity:BRighTness	139
4-21-13. :UTILity:LANGuage.....	140
4-21-14. :UTILity:REMOte.....	140
4-21-15. :UTILity:REMOte:MODE	140
4-22. Interface Commands	141
4-22-1. :UTILity:INTErface.....	141
4-22-2. :UTILity:BRATe.....	141
4-22-3. :UTILity:SBIT.....	142
4-22-4. :UTILity:PARity.....	142
4-23. File Commands	143
4-23-1. :MEMory:SAVE	143
4-23-2. :MEMory:RECall	143
4-23-3. :PREset:SAVE	143
4-23-4. :PREset:RECall.....	143

4-23-5. :SETup:SAVE	144
4-23-6. :SETup:RECall.....	144
4-23-7. :FACTory[:RECall]	144
4-23-8. :USER[:DEFault]:SAVE	144
4-23-9. :USER[:DEFault]:RECall.....	144
4-24. SCPI Status Commands	145
4-24-1. :SYSTem:ERRor.....	145
4-24-2. :STATus:PRESet	145
4-25. Csummary Status Commands	146
4-25-1. :STATus:CSUMmary:CONDition	146
4-25-2. :STATus:CSUMmary:ENABle	146
4-25-3. :STATus:CSUMmary[:EVENT].....	146
4-25-4. :STATus:CSUMmary:NTRansition.....	147
4-25-5. :STATus:CSUMmary:PTRansition.....	147
4-26. Operation Status Commands	148
4-26-1. :STATus:OPERation:CONDition.....	148
4-26-2. :STATus:OPERation:ENABle.....	148
4-26-3. :STATus:OPERation[:EVENT]	148
4-26-4. :STATus:OPERation:NTRansition	149
4-26-5. :STATus:OPERation:PTRansition.....	149
4-27. Questionable Status Commands	150
4-27-1. :STATus:QUESTionable:CONDition	150
4-27-2. :STATus:QUESTionable:ENABle.....	150
4-27-3. :STATus:QUESTionable[:EVENT].....	150
4-27-4. :STATus:QUESTionable:NTRansition.....	151
4-27-5. :STATus:QUESTionable:PTRansition.....	151
5. Status Register Overview	152
5-1. Introduction to the Status Registers.....	152
5-2. Configuration in the Status register	153
5-3. Csummary Status Register Group.....	154
5-4. Operation Status Register Group.....	156
5-5. Questionable Status Register Group.....	157
5-6. Standard Event Status Register Group	159
5-7. Status Byte Register Group	161
6. Appendix.....	163
6-1. ERROR MESSAGE	163
6-2. Change History	170

1. INTERFACE OVERVIEW

This manual describes how to use the LSG Series remote command functionality and lists the command details.

1-1. Front Panel Overview

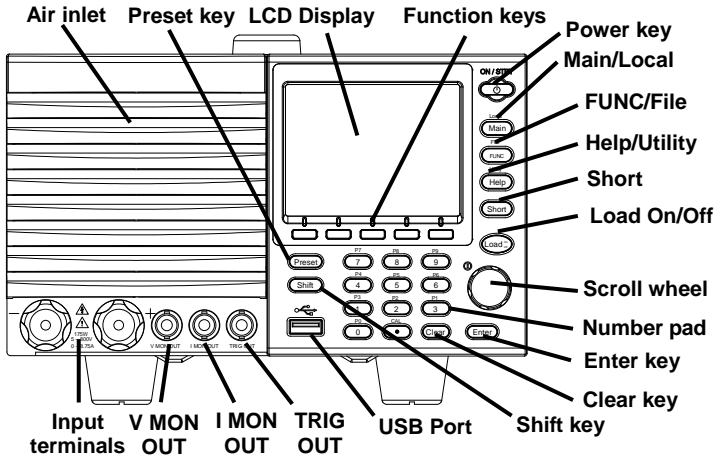

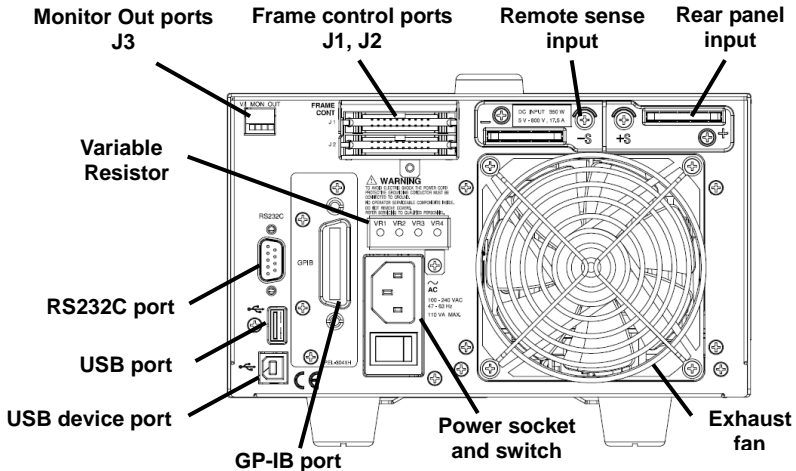

1-2. Rear Panel Overview



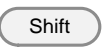

2. INTERFACE Configure

2-1. Configuring the USB Interface

USB	PC side connector	Type A, host
	LSG side connector	Rear panel Type B, device port
	Speed	2.0 (full speed)
	USB Class	USB CDC
 Note	Before USB can be used for remote control, it is necessary to install the USB device driver, located on the accompanying User Manual CD.	
Operation	<ol style="list-style-type: none"> 1. Connect the USB cable to the rear panel USB B port. 	
	Utility	
	<ol style="list-style-type: none"> 2. Press  >  > <i>Interface</i> [F3] in order, and set the Interface setting to USB. 	
	It is recognized from the PC by virtual COM port connection. Please refer to the instruction manual for more information.	

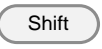
2-2. Configuring the RS-232C Interface

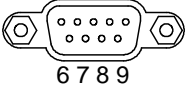
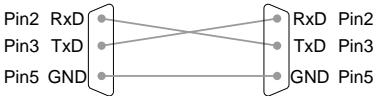
RS-232C	Connector	DB-9, Male
	Baud Rate	2400, 4800, 9600, 19200, 38400
	Stop Bit	1, 2
	Parity	None, Odd, Even
Operation	<ol style="list-style-type: none"> 1. Connect an RS-232C cable from the PC to the rear panel RS-232C port. 	
	Utility	
	<ol style="list-style-type: none"> 2. Press  >  > <i>Interface</i> [F3] in order, and set the Interface setting to <i>RS232</i>. 3. Set the <i>Baud Rate</i>, <i>Stop Bit</i> and <i>Parity</i> settings. Data bits are fixed to 8 bits. 	
Pin Assignment	 <p>1 2 3 4 5 6 7 8 9</p>	<p>2: RxD (Receive data) 3: TxD (Transmit data) 5: GND 4,6,7,8,9: No connection</p>
PC Connection	Use a null modem connection as shown in the diagram below.	
	LSG-H	PC
	<p>Pin2 RxD Pin3 TxD Pin5 GND</p> 	<p>RxD Pin2 TxD Pin3 GND Pin5</p>

2-3. Configuring the GP-IB Interface

To use GP-IB, the optional GP-IB port must be installed.
Please refer to the instruction manual for more information.

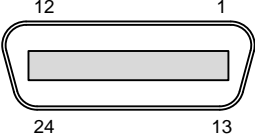
Operation	<ol style="list-style-type: none"> 1. Ensure the LSG Series is off before proceeding. 2. Connect a GP-IB cable from a GP-IB controller to the GP-IB port on the LSG Series. 3. Turn the LSG Series on. <div style="text-align: center; margin: 5px 0;"><small>Utility</small></div> <ol style="list-style-type: none"> 4. Press Shift > Help > <i>Interface</i> [F3] in order, and set the <i>Interface</i> setting to <i>GP-IB</i>. 5. Set the GP-IB address. GP-IB address 0~30 																																											
GP-IB constraints	<p>Maximum 15 devices altogether, 20m cable length, 2m between each device. Unique address assigned to each device. At least 2/3 of the devices turned On. No loop or parallel connection.</p>																																											
Pin Assignment	<div style="text-align: center; margin-bottom: 10px;">  </div> <table border="1" style="width: 100%; border-collapse: collapse;"> <thead> <tr> <th style="width: 10%;">Pin</th> <th style="width: 40%;">Signal</th> <th style="width: 10%;">Pin</th> <th style="width: 40%;">Signal</th> </tr> </thead> <tbody> <tr> <td>1~4</td> <td>Data I/O 1~4</td> <td>13~16</td> <td>Data I/O 5~8</td> </tr> <tr> <td>5</td> <td>EOI</td> <td>17</td> <td>REN</td> </tr> <tr> <td>6</td> <td>DAV</td> <td>18</td> <td>Ground (DAV)</td> </tr> <tr> <td>7</td> <td>NRFD</td> <td>19</td> <td>Ground (NRFD)</td> </tr> <tr> <td>8</td> <td>NDAC</td> <td>20</td> <td>Ground (NDAC)</td> </tr> <tr> <td>9</td> <td>IFC</td> <td>21</td> <td>Ground (IFC)</td> </tr> <tr> <td>10</td> <td>SRQ</td> <td>22</td> <td>Ground (SRQ)</td> </tr> <tr> <td>11</td> <td>ATN</td> <td>23</td> <td>Ground (ATN)</td> </tr> <tr> <td>12</td> <td>SHIELD Ground</td> <td>24</td> <td>Single GND</td> </tr> </tbody> </table>				Pin	Signal	Pin	Signal	1~4	Data I/O 1~4	13~16	Data I/O 5~8	5	EOI	17	REN	6	DAV	18	Ground (DAV)	7	NRFD	19	Ground (NRFD)	8	NDAC	20	Ground (NDAC)	9	IFC	21	Ground (IFC)	10	SRQ	22	Ground (SRQ)	11	ATN	23	Ground (ATN)	12	SHIELD Ground	24	Single GND
Pin	Signal	Pin	Signal																																									
1~4	Data I/O 1~4	13~16	Data I/O 5~8																																									
5	EOI	17	REN																																									
6	DAV	18	Ground (DAV)																																									
7	NRFD	19	Ground (NRFD)																																									
8	NDAC	20	Ground (NDAC)																																									
9	IFC	21	Ground (IFC)																																									
10	SRQ	22	Ground (SRQ)																																									
11	ATN	23	Ground (ATN)																																									
12	SHIELD Ground	24	Single GND																																									

2-4. RS-232C/USB Remote Control Function Check

Functionality
check

Invoke a terminal application such as RealTerm or Putty.
For RS-232C, set the COM port, baud rate, stop bit, data bit
and parity accordingly.
To check the COM settings in Windows, see the Device
Manager from Control Panel.



Note

If you are not familiar with using a terminal application to
send/receive remote commands from the serial port or via a
USB connection.
Run this query command via the terminal after the instrument
has been configured for RS-232/USB remote control.
`*IDN?`
This should return the Manufacturer, Model number, Serial
number, and Firmware version in the following format.
TEXIO,LSG-1050H,XXXXXXXXX,V.X.X.X
Manufacturer: TEXIO
Model number : LSG-1050H
Serial number : XXXXXXXXXX
Firmware version : V.X.X.X

2-5. Using RealTerm to Establish a Remote Connection

Background

RealTerm is a terminal program that can be used to communicate with a device attached to the serial port of a PC or via an emulated serial port via USB.

The following instructions apply to version 1.99.0.27.

Even though RealTerm is used as an example to establish a remote connection, any terminal program can be used that has similar functionality.



Note

RealTerm can be downloaded on Sourceforge.net free of charge.

For more information please see <http://realterm.sourceforge.net/>

Operation(1/2)

1. Download RealTerm and install according to the instructions on the RealTerm website.
2. Connect the LSG Series via USB or via RS-232C.
3. If using RS-232C, make note of the configured baud rate, stop bits and parity.
4. Go to the Windows device manager and find the COM port number for the connection.

Double click the *Ports* icon to reveal the connected serial port devices and the COM port for the each connected device.

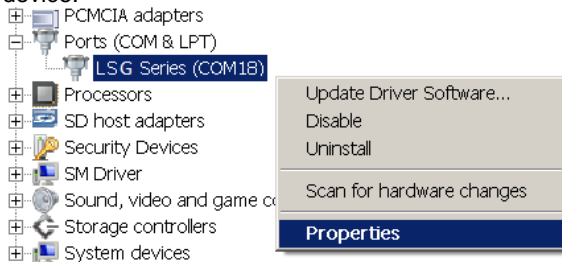

The baud rate, stop bit and parity settings can be viewed by right-clicking connected device and selecting the *Properties* option.

-
5. Start RealTerm on the PC as an administrator.
Click:

Start menu>All Programs>RealTerm>RealTerm

Tip: to run as an administrator, you can right click the RealTerm icon in the Windows Start menu and select the *Run as Administrator* option.

- After RealTerm has started, click on the *Port* tab. Enter the *Baud*, *Parity*, *Data bits (8bits)*, *Stop bits* and *Port* number configuration for the connection. The *Hardware Flow Control*, *Software Flow Control* options can be left at the default settings. Press *Open* to connect to the LSG Series.

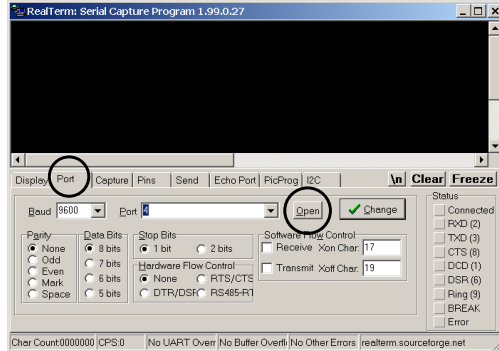

- Click on the *Send* tab. In the *EOL* configuration, check on the *+CR* and *+LF* check boxes. Enter the query: **idn?* Click on *Send ASCII*.

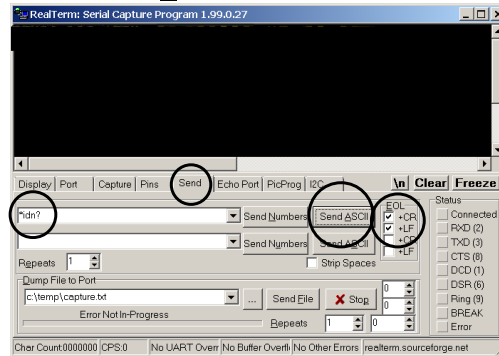

- The terminal display will return the following:
TEXIO, LSG-XXXXH,XXXXXXXXXX,VX.XX.XXX
(manufacturer, model, serial number, version)



Note

If RealTerm fails to connect to the LSG Series, please check all the cables and settings and try again.

2-6. GP-IB Function Check

Functionality
check

Please use the National Instruments Measurement & Automation Controller software to confirm GP-IB functionality. See the National Instrument website, <http://www.ni.com> for details.



Note

For further details, please see the programming manual, available on the TEXIO TECHNOLOGY web site www.texio.co.jp

Operation(1/2)

1. Start the NI Measurement and Automation Explorer (MAX) program. Using Windows, press:

Start>All Programs>National Instruments>Measurement & Automation

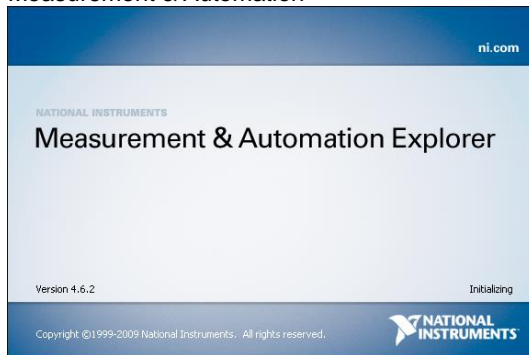

Operation(2/2)

- From the Configuration panel access; My System>Devices and Interfaces>GPIO
- Press the *Scan for Instruments* button.
- In the *Connected Instruments* panel the LSG Series should be detected as *Instrument 0* with the address the same as that configured on the LSG Series.
- Double click the *Instrument 0* icon.

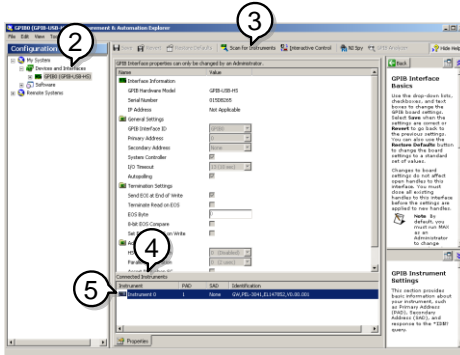

- Double click the *Instrument 0* icon.
- In the *NI-488.2 Communicator* window, ensure **IDN?* is written in the *Send String* text box. Click on the *Query* button to send the **IDN?* query to the instrument.
- The *String Received* text box will display the query return: *TEXIO, LSG-XXXXH,XXXXXXXXXX, VX.XX.XXX* (manufacturer, model, serial number, version)

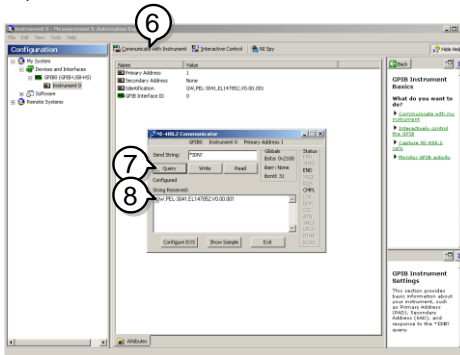

The function check is complete.

3. COMMAND OVERVIEW

The command syntax section shows you the basic syntax rules you have to apply when using commands.

3-1. Command Syntax

Compatible Standard	IEEE488.2 SCPI, 1999	Partial compatibility Partial compatibility
Command Structure	<p>SCPI (Standard Commands for Programmable Instruments) commands follow a tree-like structure, organized into nodes. Each level of the command tree is a node. Each keyword in a SCPI command represents each node in the command tree. Each keyword (node) of a SCPI command is separated by a colon (:).</p> <p>For example, the diagram below shows an SCPI sub-structure and a command example.</p> <div style="text-align: center;"> <div style="border: 1px solid black; display: inline-block; padding: 2px 10px;">[:MODE]:CRANGe</div> :MODE <div style="display: flex; justify-content: center; gap: 20px;"> <div style="text-align: center;"> :CRANGe </div> <div style="text-align: center;"> :VRANGe </div> <div style="text-align: center;"> :RESPonse </div> </div> </div>	
Command types	<p>There are a number of different instrument commands and queries. A command sends instructions or data to the unit and a query receives data or status information from the unit.</p>	
Simple command	<p>A single command with/without a parameter.</p>	
Example Query	<p>:CONFIgure:RESPonse MAX A query is a simple or compound command followed by a question mark (?). A parameter (data) is returned.</p>	
Example	<p>:CONFIgure:RESPonse?</p>	
Compound command	<p>Two or more commands on the same command line. Compound commands are separated with either a semi-colon (;) or a semi-colon and a colon (;:). A semi-colon is used to join two related commands, with the caveat that the last command must begin at the last node of the first command. A semi-colon and colon are used to combine two commands from different nodes.</p>	
Example	<p>CONFIgure:VON MAX;:CONFIgure:VDElAy MIN</p>	

Command forms	<p>Commands and queries have two different forms, long and short. The command syntax is written with the short form of the command in capitals and the remainder (long form) in lower case.</p> <p>The commands can be written in capitals or lower-case, just so long as the short or long forms are complete. An incomplete command will not be recognized.</p> <p>Below are examples of correctly written commands.</p>																								
Example	<table border="1"> <tr> <td>Long form</td> <td>Short form</td> </tr> <tr> <td>:CURRENT:LEVEL?</td> <td>:CURR:LEV?</td> </tr> <tr> <td>:current:level?</td> <td>:curr:lev?</td> </tr> </table>	Long form	Short form	:CURRENT:LEVEL?	:CURR:LEV?	:current:level?	:curr:lev?																		
Long form	Short form																								
:CURRENT:LEVEL?	:CURR:LEV?																								
:current:level?	:curr:lev?																								
Square brackets	<p>Commands that contain square brackets indicate that the contents are optional. The function of the command is the same with or without the square bracketed items, as shown below</p> <p>For example for the query: “[:CONFigure]:GNG [:PASS]?” Both “:CONFigure:GNG:PASS?” and “:GNG?” are both valid forms.</p>																								
Command format	<p style="text-align: center;">:CURRent:SET 1.00A</p> <p style="text-align: center;">1 2 3 4</p> <p style="text-align: center;">1: Command header 3: Parameter 1 2: Space 4: Unit or suffix.</p>																								
Common input parameters (1/2)	<table border="1"> <thead> <tr> <th>Type</th> <th>Description</th> <th>Example</th> </tr> </thead> <tbody> <tr> <td><Boolean></td> <td>boolean logic</td> <td>0, 1</td> </tr> <tr> <td><NR1></td> <td>integers</td> <td>0, 1, 2, 3</td> </tr> <tr> <td><NR2></td> <td>decimal numbers</td> <td>0.1, 3.14, 8.5</td> </tr> <tr> <td><NR3></td> <td>floating point</td> <td>4.5e-1, 8.25e+1</td> </tr> <tr> <td><NRf></td> <td>any of NR1, 2, 3</td> <td>1, 1.5, 4.5e-1</td> </tr> <tr> <td>[MIN] (Optional parameter)</td> <td>For commands, this will set the setting to the lowest value. This parameter can be used in place of any numerical parameter where indicated. For queries, it will return the lowest possible value allowed for the particular setting.</td> <td></td> </tr> <tr> <td>[MAX] (Optional parameter)</td> <td>For commands, this will set the setting to the highest value. This parameter can be used in place of any numerical parameter where indicated. For queries, it will return the highest possible value allowed for the particular setting.</td> <td></td> </tr> </tbody> </table>	Type	Description	Example	<Boolean>	boolean logic	0, 1	<NR1>	integers	0, 1, 2, 3	<NR2>	decimal numbers	0.1, 3.14, 8.5	<NR3>	floating point	4.5e-1, 8.25e+1	<NRf>	any of NR1, 2, 3	1, 1.5, 4.5e-1	[MIN] (Optional parameter)	For commands, this will set the setting to the lowest value. This parameter can be used in place of any numerical parameter where indicated. For queries, it will return the lowest possible value allowed for the particular setting.		[MAX] (Optional parameter)	For commands, this will set the setting to the highest value. This parameter can be used in place of any numerical parameter where indicated. For queries, it will return the highest possible value allowed for the particular setting.	
Type	Description	Example																							
<Boolean>	boolean logic	0, 1																							
<NR1>	integers	0, 1, 2, 3																							
<NR2>	decimal numbers	0.1, 3.14, 8.5																							
<NR3>	floating point	4.5e-1, 8.25e+1																							
<NRf>	any of NR1, 2, 3	1, 1.5, 4.5e-1																							
[MIN] (Optional parameter)	For commands, this will set the setting to the lowest value. This parameter can be used in place of any numerical parameter where indicated. For queries, it will return the lowest possible value allowed for the particular setting.																								
[MAX] (Optional parameter)	For commands, this will set the setting to the highest value. This parameter can be used in place of any numerical parameter where indicated. For queries, it will return the highest possible value allowed for the particular setting.																								

Common input parameters (2/2)	Unit Suffixes (Optional parameters)	Unit suffixes can be optionally used with most NRF type input parameters.	
	Type	Description	Example
	[A]	Amps	1.00A
	[%]	Percentage	10%
	[V]	Volts	5.00V
	[W]	Watts	3.00W
	[ms]	milliseconds	20ms
	[mV]	Millivolts	150mV
	[s]	Seconds	5s
	[OHM]	Ohm	50OHM
	[mS]	Reciprocal of 1k ohms	20mS
	[MHO]	Reciprocal of one ohm	0.02MHO
	[mA/us]	Milliamps/microsecond	100mA/us
[Hz]	Hertz	6.0e+1Hz	
Message terminator	LF	Line feed code (0x0A)	

4. COMMAND DETAILS

4-1. Common Commands

4-1-1. *CLS

Set →

Description	Clears all Event registers and queues.
Setting syntax	*CLS
Setting example	*CLS Clears all Event registers and queues.

4-1-2. *ESE

Set →
→ Query

Description	Queries or sets the Standard Event Status Enable register. The Standard Event Status Enable register determines which events can set the Event Summary bit (ESB) in the Status Byte Register. Any bits that are set to 1 enable the corresponding event. Each event is represented by a bit in the Standard Event Status Enable register. Refer to the page 159 (5-6.Standard Event Status register group) for more information on bit.
Setting syntax	*ESE <NR1>
Setting parameter	<NR1> Sets the Standard Event Status Enable register.
Setting example	*ESE 8 Sets bit 3 of the ESE register.
Query syntax	*ESE?
Return parameter	<NR1> Return the set value of the Standard Event Status Enable register.
Query example	*ESE? >12 Bits 2 and 3 are set in the Standard Event Status Enable register.

4-1-3. *ESR

→ Query

Description	Reads the Standard Event Status register. This command will also clear the Standard Event Status register. Refer to the page 159 (5-6.Standard Event Status register group) for more information on bit.	
Query syntax	*ESR?	
Return parameter	<NR1>	Return the set value of the Standard Event Status register.
Query example	*ESR? >48 Bits 5 and 6 are set in the Standard Event register.	

4-1-4. *IDN

→ Query

Description	Queries the manufacturer, model number, serial number, and firmware version of the instrument.	
Query syntax	*IDN?	
Return parameter	<ASCII string>	Returns the manufacture name.
	<ASCII string>	Returns the model name.
	<NR1>	Returns the serial number.
	<ASCII string>	Returns the version of firmware.
Query example	* IDN? > TEXIO,LSG-175H,12345678,V1.01.001 It is a response equipment manufacturer, model number, serial number, and firmware version.	

4-1-5. *OPC

Set →
→ Query

Description	This command sets the OPC (Operation Command Bit) bit (bit 0) of the Standard Event Status Register after the instrument has completed all pending operations. The query will return the status of the OPC bit.	
Setting syntax	*OPC	
Setting example	*OPC	
Query syntax	*OPC?	
Return parameter	1	Operation complete.
Query example	*OPC? >1 Indicates that all pending operations are complete.	

4-1-6. *RCL

Set →

Description	The Recall Instrument State command restores the instrument settings from a previously saved memory setting.
Setting syntax	*RCL <NR1>
Setting parameter	<NR1> Memory number 1 to 256
Setting example	*RCL 20 Recall setting memory 20.
Same function command	:MEMory:RECall

4-1-7. *RST

Set →

Description	Resets the unit. This is command forces the :ABORt, and *CLS.
Setting syntax	*RST
Setting example	*RST Resets the unit.

4-1-8. *SAV

Set →

Description	The Save Instrument State command saves the instrument settings to one of the memory setting slots.
Setting syntax	*SAV <NR1>
Setting parameter	<NR1> Memory number 1 to 256
Setting example	*SAV 20 Saves the current setting to memory 20.
Same function command	:MEMory:SAVe

Set →

→ Query

4-1-9. *SRE

Description	Queries or sets the Service Request Enable register. The Service Request Enable register determines which events in the Status Byte register can set the Master Summary bit (MSB) in the Status Byte Register. Any bits that are set to 1 will cause the MSS bit to be set. Refer to the page 161 (5-7.Status register group) for more information on bit.
Setting syntax	*SRE <NR1>
Setting parameter	<NR1> Sets the set value of the Service Request Enable register.
Setting example	*SRE 8 Sets bit 3 of the Service Request Enable register.
Query syntax	*SRE?
Return parameter	<NR1> Return the set value of the Service Request Enable register.
Query example	*SRE? >12 Bits 2 and 3 are set in the Service Request Enable register.

4-1-10. *STB

→ Query

Description	Reads the Status Byte register. This command will not clear the Status Byte register. If the Master Summary Status bit (MSS) is set, it indicates that there is a reason for a service request. Refer to the page 161 (5-7.Status register group) for more information on bit.
Query syntax	*STB?
Return parameter	<NR1> Return the value of the Status Byte register.
Query example	*STB? >36 Bits 2 and 5 are set in the Status Byte register.

4-1-11. *TRG

Set →

Description	This command is issue the enforcement trigger.
Setting syntax	*TRG
Setting example	*TRG Issue the enforcement trigger.
Related commands	:INITiate:CONTInuous, :INITiate[:IMMEDIATE]

4-1-12. *TST

→ Query

Description	This command is a standard SCPI self-test command. The LSG series does not perform any self-tests so will always return 0 (pass) for this command.
Query syntax	*TST?
Return parameter	0 Pass
Query example	*TST? >0

4-2. Trigger Commands

Trigger States

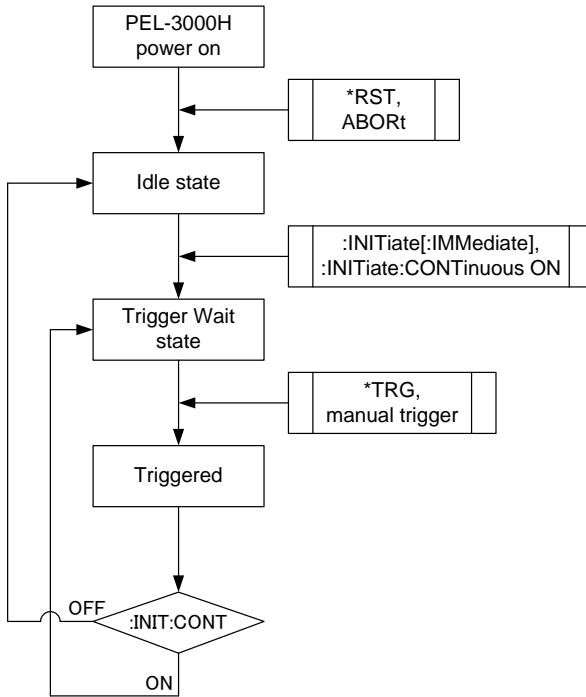

4-2-1. :ABORt

Set →

Description	Clears the trigger wait status and returns to the idle state.	
Setting syntax	:ABORt	
Setting example	:ABOR	
	Clears the trigger wait status.	

4-2-2. :INPut[:STATe]:TRIGgered

Set →

Description	Sets whether to turn on the load input when the trigger is activated. Sets when LSG is idle state.	
Setting syntax	:INPut[:STATe]:TRIGgered {<Boolean> OFF ON}	
Setting parameter	OFF 0	Not change the load input in when the trigger active.
	ON 1	Turn on the load input in when the trigger active.
Setting example	:INP:TRIG ON Turn on the load input in when the trigger active.	
Related commands	*TRG, :INITiate:CONTInuous, :INITiate[:IMMEDIATE]	

4-2-3. :INITiate[:IMMEDIATE]

Set →

Description	Sets the trigger to the wait state. If the trigger is activated, the trigger will automatically go to the idle state.	
Setting syntax	:INITiate[:IMMEDIATE]	
Setting example	:INIT	
	Sets the trigger to the wait state.	
Related commands	*TRG, :INPut[:STATe]:TRIGgered, :CURRent[:VA]:TRIGgered, :RESistance[:VA]:TRIGgered	

Set →
 → Query

4-2-4. :INITiate:CONTInuous

Description	Setting or query for state of the continuous waiting for the trigger. Note: Release of the trigger wait state requires activation of the trigger.	
Setting syntax	:INITiate:CONTInuous {<Boolean> OFF ON}	
Setting parameter	OFF 0	Remove the continuous waiting for the trigger.
	ON 1	Sets to continuous waiting for the trigger.
Setting example	:INIT:CONT ON Sets to continuous waiting for the trigger.	
Query syntax	:INITiate:CONTInuous?	
Return parameter	<Boolean>	Return the set value of the continuous waiting for the trigger.
Query example	:INIT:CONT? >1 Setting in a continuous wait for trigger, and wait for the trigger.	
Related commands	*TRG, :INPut[:STATe]:TRIGgered, :CURRent[:VA]:TRIGgered, :RESistance[:VA]:TRIGgered	

Set →
 → Query

4-2-5. :TRIGger[:DELay]:TIME

Description	The command determines how long to delay any action after a trigger is received. Equivalent to using the “Trig In Delay” setting on the front panel.	
Setting syntax	:TRIGger[:DELay]:TIME {<NR2> MINimum MAXimum}	
Setting parameter	<NR2>	Set the delay time in seconds. (0 ~ 0.005)
	MINimum	Minimum delay time
	MAXimum	Maximum delay time
Setting example	:TRIG:TIME 0.005 Sets the trigger in delay to 5ms.	
Query syntax	:TRIGger[:DELay]:TIME?	
Return parameter	<NR2>	Returns the delay time.
Query example	:TRIG:TIME? >0.0050000 Returns the delay time in seconds.	

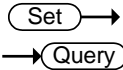

4-2-6. :TRIGger[:PULSe]:WIDTh

Description	Setting and query for the trigger output signal's pulse width.	
Setting syntax	:TRIGger[:PULSe]:WIDTh {<NR2> MINimum MAXimum}	
Setting parameter	<NR2>	Set the pulse width in seconds. (0.0000025~0.005)
	MINimum	Minimum pulse width
	MAXimum	Maximum pulse width
Setting example	:TRIG:WIDTh MAX Sets the trigger pulse width to Maximum.	
Query syntax	:TRIGger[:PULSe]:WIDTh?	
Return parameter	<NR2>	Returns the pulse width
Query example	TRIG:WIDTh? >0.0050000 Returns the pulse width of the trigger output.	

4-3. Input Commands

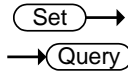

4-3-1. :INPut

Description	Setting and Query for the status of the load. Setting stop and restart of program, sequence, OCP test.	
Setting syntax	:INPut {<Boolean> OFF ON}	
Setting parameter	OFF 0	Sets the off the load input setting. Sets stop of program, sequence, OCP test.
	ON 1	Sets the on the load input setting. Sets restart of program, sequence, OCP test.
Setting example	:INP ON Sets the on the load input setting.	
Query syntax	:INPut?	
Return parameter	<Boolean>	Return the set value of the load input.
Query example	:INP? >1 Load input setting is on.	

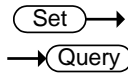

4-3-2. :INPut:MODE

Description	Setting and query for the operating function of the load.	
Setting syntax	:INPut:MODE {LOAD PROG NSEQ FSEQ}	
Setting parameter	LOAD	Sets the manual operation.
	PROG	Sets the program function.
	NSEQ	Sets the normal sequence function.
	FSEQ	Sets the fast sequence function.
Setting example	:INPut:MODE LOAD Sets to the manual operation.	
Query syntax	:INPut:MODE	
Return parameter	LOAD PROG NSEQ FSEQ	Return the operating function of the load
Query example	:INP:MODE? >LOAD Mode of operation is the manual operation.	

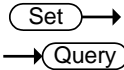

4-3-3. [:INPut]:SHORT

Description	Setting and query for the input terminals state (open or short).
Setting syntax	[:INPut]:SHORT {<Boolean> OFF ON}
Setting parameter	OFF 0 Sets the open. ON 1 Sets the short.
Setting example	:SHOR ON Sets the short.
Query syntax	[:INPut]:SHORT?
Return parameter	<Boolean> Return the input terminals state.
Query example	:SHOR? >1 The input terminals state is short.

4-4. Measurement Commands

4-4-1. :MEASure:CURRent

→ Query

Description	Query of current measurement.
Query syntax	:MEASure:CURRent?
Return parameter	<NR2> Return the current measurement. The unit is the [A].
Query example	:MEAS:CURR? >0.50000 Current measurement is 0.5A.

4-4-2. :MEASure:ETIME

→ Query

Description	Query of the elapsed time of the load-on.
Query syntax	:MEASure:ETIME?
Return parameter	<NR2> Return the elapsed time of the load-on. The unit is the seconds.
Query example	:MEAS:ETIM? >10.0 The elapsed time of the load-on is 10 seconds.

4-4-3. :MEASure:POWer

→ Query

Description	Query of power measurement.
Query syntax	:MEASure:POWer?
Return parameter	<NR2> Return the power measurement. The unit is the [W].
Query example	:MEAS:POW? >15.00000 Power measurement is 15W.

4-4-4. :MEASure:VOLTage

→ Query

Description	Query of voltage measurement.
Query syntax	:MEASure:VOLTage?
Return parameter	<NR2> Return the voltage measurement. The unit is the [V].
Query example	:MEAS:VOLT? >5.00000 Voltage measurement is 5V.

4-5. Fetch Commands

4-5-1. :FETCh:CURRent

→ Query

Description	This query returns the real-time current of the load input.
Query syntax	FETCh:CURRent?
Return parameter	<NR2> Returns the real-time current .The unit is [A]
Query example	:FETC:CURR? >0.50000 The load has a current of 0.5 amps at the input.

4-5-2. :FETCh:POWer

→ Query

Description	This query returns the real-time power of the load input.
Query syntax	FETCh:POWer?
Return parameter	<NR2> Returns the real-time power. The unit is [W].
Query example	:FETC:POW? >15.00000 The load is at 15 watts.

4-5-3. :FETCh:VOLTage

→ Query

Description	This query returns the real-time voltage of the load input.
Query syntax	FETCh:VOLTage?
Return parameter	<NR2> Returns the real-time voltage. The unit is [V].
Query example	:FETC:VOLT? >5.00000 The load has a voltage of 5 volts at the input.

4-6. Configure Subsystem Commands

Set →

4-6-1. [:CONFigure]:OCP

→ Query

Description	Setting and query for the OCP trip settings. The OCP limit can be set to a specific value or the trip setting can be set to either limit the current or to turn the load off.	
Setting syntax	[:CONFigure]:OCP {<NRf> MINimum MAXimum LIMit LOFF}	
Setting parameter	<NRf>	OCP value. The unit is [A]
	MINimum	Minimum OCP value.
	MAXimum	Maximum OCP value.
	LIMit	Limit the current.
Setting example1	LOFF	Turn the load off.
	:OCP LIM Sets the OCP setting to limit.	
Setting example2	:OCP 19.250 Sets the OCP value to 19.25A.	
Query syntax	[:CONFigure]:OCP?	
Return parameter	LIMit, <NR2>	Return the limit the current and the OCP value.
	LOFF, <NR2>	Return to turn the load off and the OCP value.
Query example	:OCP? >LIMIT, 19.250 The OCP setting is LIMIT and the OCP value is 19.25A.	

Set →
 → Query

4-6-2. [:CONFigure]:OPP

Description	Setting and query for the OPP trip settings. The OPP limit can be set to a specific value or the trip setting can be set to either limit the power or to turn the load off.	
Setting syntax	[:CONFigure]:OPP	
Setting parameter	{<NRf> MINimum MAXimum LIMit LOFF}	
	<NRf>	OPP value. The unit is [W]
	MINimum	Minimum OPP value.
	MAXimum	Maximum OPP value.
	LIMit	Limit the power
LOFF	Turn the load off	
Setting example1	:OPP LIM Sets the OPP setting to limit.	
Setting example2	:OPP 10.000 Sets the OPP value to 10W.	
Query syntax	[:CONFigure]:OPP?	
Return parameter	LIMIT, <NR2>	Return the limit the power and the OPP value.
	LOFF, <NR2>	Return to turn the load off and the OPP value.
Query example	:OPP? >LIMIT, 10.000 The OPP setting is LIMIT and the OPP value is 10W.	

Set →
 → Query

4-6-3. [:CONFigure]:UVP

Description	Setting and query for the UVP trip settings.	
Setting syntax	[:CONFigure]:UVP {<NRf> MINimum MAXimum}	
Setting parameter	<NRf>	UVP value. ; 0 = OFF, The unit is [V]
	MINimum	Minimum UVP value. (UVP setting is OFF.)
	MAXimum	Maximum UVP value.
Setting example	:UVP 10.0 Sets the UVP setting to 10V.	
Query syntax	[:CONFigure]:UVP?	
Return parameter	<NR2>	Return the set value of the UVP.
Query example	:UVP? >10.0 The UVP setting is 10V.	

Set →
 → Query

4-6-4. [:CONFigure]:UVP:TIME

Description	Setting and query for the UVP ring time setting.	
Setting syntax	[:CONFigure]:UVP:TIME	
Setting parameter	{<NR1> MINimum MAXimum INFinity}	
	<NR1>	The ring time in seconds (0~600); 0 = OFF The unit is [s].
	MINimum	Minimum ring time
	MAXimum	Maximum ring time
	INFinity	Sets the ring time to infinity.
Setting example	:UVP:TIME 5 Sets the UVP ring time to 5 seconds.	
Query syntax	[:CONFigure]:UVP:TIME?	
Return parameter	<NR1> Infinity OFF	Return the set value of the UVP ring time. "OFF" is the ring time off.
Query example	:UVP:TIME? >5 The UVP ring time is 5 seconds.	

Set →
 → Query

4-6-5. [:CONFigure]:OVP

Description	Setting and query for the OVP trip settings.	
Setting syntax	[:CONFigure]:OVP {<NRf> MINimum MAXimum}	
Setting parameter	<NRf>	
	<NRf>	Over voltage limit value. The unit is [V].
	MINimum	Minimum value.
	MAXimum	Maximum value. (OVP setting is OFF.)
Setting example	:OVP 10.0 Sets the OVP setting to 10V.	
Query syntax	[:CONFigure]:OVP?	
Return parameter	<NR2> OFF	Return the set value of the OVP, by the string. "OFF" is a function off.
Query example	:OVP? >10.0 The OVP setting is 10V.	

Set →
 → Query

4-6-6. [:CONFigure]:SStart

Description	Setting and query for the Soft Start time setting.	
Setting syntax	[:CONFigure]:SStart {<NRf> OFF MINimum MAXimum}	
Setting parameter	<NRf>	The soft start time in seconds. The unit is [s].
	OFF	OFF = 0 seconds
	MINimum	Minimum time = 0 seconds
	MAXimum	Maximum time
Setting example	:SST OFF Turns the soft start function off.	
Query syntax	[:CONFigure]:SStart?	
Return parameter	<NR2> OFF	Return the set value of the soft-start time, by the string. "OFF" is a function off.
Query example	:SST? >OFF The soft start function is off.	

Set →
 → Query

4-6-7. [:CONFigure]:VON

Description	Setting and query for the Von voltage settings and latch.	
Setting syntax	[:CONFigure]:VON {<NRf> MINimum MAXimum LON LOFF}	
Setting parameter	<NRf>	The Von voltage value. The unit is [V].
	MINimum	Minimum Von voltage value.
	MAXimum	Maximum Von voltage value.
	LON	Latch on.
	LOFF	Latch off.
Setting example	:VON 10.0V LON Sets the Von voltage value to 10.0 volts and Von latch ON.	
Query syntax	[:CONFigure]:VON?	
Return parameter	Latch OFF ON ,<NR2>	Return the Von value and the mode of operation, by the string.
Query example	:VON? >Latch OFF, 0.00 The Von voltage value is 0V.	

Set →
 → Query

4-6-8. [:CONFigure]:VDElay

Description	Setting and query for the Von Delay settings in seconds.	
Setting syntax	[:CONFigure]:VDElay {<NRf> OFF MINimum MAXimum }	
Setting parameter	<NRf>[s]	The delay time in seconds. The unit is [s].
	OFF	Disable the delay time
	MINimum	Minimum delay time
	MAXimum	Maximum delay time
Setting example1	:VDEL 2.5ms Sets the delay time to 2.5ms.	
Setting example2	:VDEL 0.0025s Sets the delay time to 2.5ms.	
Query syntax	[:CONFigure]:VDElay?	
Return parameter	<NR2> OFF	Return the set value of the delay time, by the string. "OFF" is a function off.
Query example	:VDEL? >0.0025 The delay time is 2.5ms.	

Set →
 → Query

4-6-9. :CONFigure:RESPonse

Description	Setting and query for the response speed of the CC, CR and CP mode.	
Setting syntax	:CONFigure:RESPonse{<NR2> MINimum MAXimum}	
Setting parameter	<NR2>	0.1, 0.2, 0.5, 1.0
	MINimum	Minimum response speed
	MAXimum	Maximum response speed
Setting example	:CONF:RESP MAX Sets the response to the maximum of the CC, CR and CP mode.	
Query syntax	:CONFigure:RESPonse?	
Return parameter	<NR2>	Return the set value of the response speed.
Query example	:CONF:RESP? >1.0 Response speed of the CC, CR and CP mode is 1.0.	

Set →
 → Query

4-6-10. [:CONFigure]:CNTime

Description	Setting and query for the Count time timer function.
Setting syntax	[:CONFigure]:CNTime {OFF ON}
Setting parameter	OFF Turns the Count Time timer off.
	ON Turns the Count Time timer on
Setting example	:CNT ON Turns the Count Time timer on.
Query syntax	[:CONFigure]:CNTime?
Return parameter	OFF ON Return the Count time timer function, by the string.
Query example	:CNT? >ON Count Time timer is turned on.

Set →
 → Query

4-6-11. [:CONFigure]:COTime

Description	Setting and query the load cutoff time. A cutoff time of 0 seconds is the equivalent of disabling the cutoff time.
Setting syntax	[:CONFigure]:COTime {<NRf> OFF MINimum MAXimum }
Setting parameter	<NRf> Cut off time in seconds (1~3599999). The unit is [s].
	OFF Turns the cutoff time off.
	MINimum Sets the cutoff time to the maximum
	MAXimum Sets the cutoff time to the minimum
Setting example	:COT MAX Sets the cutoff time to the maximum.
Query syntax	[:CONFigure]:COTime?
Return parameter	<NR1> OFF Return the set value of the Cut-off time, by the string. "OFF" is a function off.
Query example	:COT? >500 The cutoff time is set to 500 seconds.

Set →
 → Query

4-6-12. [:CONFigure]:CRUnit

Description	Setting and query for the CR mode setting units.	
Setting syntax	[:CONFigure]:CRUnit {OHM MHO}	
Setting parameter	OHM	Set the "Ω" to unit.
	MHO	Set the "mS" to unit. (conductance)
Setting example	:CRU OHM	
	Sets the CR mode units to ohms.	
Query syntax	[:CONFigure]:CRUnit?	
Return parameter	OHM MHO	Return the CR mode setting units, by the string.
Query example	:CRU?	
	>OHM	
	The CR mode units are ohms.	

Set →
 → Query

4-6-13. :CONFigure:DYNamic

Description	Setting and query for the setting conditions of dynamic mode. Setting conditions can select the duty cycle or the timer, the percentage or the value. Please refer to the Instruction Manual for details.	
Setting syntax	:CONFigure:DYNamic {VALue PERCent TIME FDUTy }	
Setting parameter	VALue	Set the units to Value.
	PERCent	Set the units to Percent.
	TIME	Use timers for timing.
	FDUTy	Use duty cycle for timing.
Setting example	:CONF:DYN VAL	
	Sets the dynamic mode units to value.	
Query syntax	:CONFigure:DYNamic?	
Return parameter	Value Percent , T1/T2 Fre./Duty	Return the unit and the timing mode, by the string.
Query example	:CONF:DYN?	
	>Value,T1/T2	
	The dynamic mode becomes a value setup and a timer setup.	

Set →
 → Query

4-6-14. :CONFIgure:MEMory

Description	<p>This command configures how the files are recalled in local operation mode.</p> <p>By default when you try to recall a file or setting from memory, a message will appear asking you to press the Enter key to confirm each time you wish to recall. This command enables (SAFety) or disables this feature (DIRect).</p>	
Setting syntax	:CONFIgure:MEMory {SAFety DIRect}	
Setting parameter	SAFety	Safety setting.
	DIRect	Directly recall the chosen file.
Setting example	:CONF:MEM SAF Enables the safety setting.	
Query syntax	:CONFIgure:MEMory?	
Return parameter	Safety Direct	Return the presence or absence of confirmation of recall, by the string.
Query example	:CONF:MEM? >Safety The safety setting is enabled.	

Set →
 → Query

4-6-15. :CONFIgure:SHORt

Description	Setting and query for the Short key behavior.	
Setting syntax	:CONFIgure:SHORt {TOGGle HOLD}	
Setting parameter	HOLD	Sets the Short key configuration to hold.
	TOGGle	Sets the Short key configuration to toggle.
Setting example	:CONF:SHOR TOGG Sets the Short key configuration to toggle.	
Query syntax	:CONFIgure:SHORt?	
Return parameter	Toggle Hold	Return the Short key Action, by the string.
Query example	:CONF:SHOR? >Toggle The Short key is configured to toggle.	

Set →
 → Query

4-6-16. :CONFigure:SHORT:SAFety

Description	Turns the Short Safety function on/off. The short safety function requires the load to already be turned on before the load can be shorted using the Short key or :INPut:SHORT command.
Setting syntax	:CONFigure:SHORT:SAFety {<Boolean> OFF ON}
Setting parameter	OFF 0 OFF ON 1 ON
Setting example	:CONF:SHOR:SAF OFF Sets the Short Safety off.
Query syntax	:CONFigure:SHORT:SAFety?
Return parameter	ON OFF Return the Short Safety function on/off.
Query example	:CONF:SHOR:SAF? >OFF Short Safety is turned off.

Set →
 → Query

4-6-17. :CONFigure:SHORT:FUNCTION

Description	Enables or disables the short function by Short key. The load cannot be shorted until the short function has been enabled with this function.
Setting syntax	CONFigure:SHORT:FUNCTION {<Boolean> OFF ON}
Setting parameter	OFF 0 Disables the short function ON 1 Enables the short function
Setting example	:CONF:SHOR:FUNC ON Enables the short function.
Query syntax	:CONFigure:SHORT:FUNCTION?
Return parameter	ON OFF Return the short key/short function.
Query example	:CONF:SHOR:FUNC? >ON Indicates that the short function is enabled.

Set →

→ Query

4-6-18. [:CONFigure]:GNG:MODE

Description	Setting and query for the entry mode for the Go-NoGo settings. The entry mode determines whether the Go-NoGo limits are set as values or as a percentage value from a center reference value.
Setting syntax	[:CONFigure]:GNG:MODE {PERCent VALue}
Setting parameter	PERCent Sets the entry mode to %. VALue Sets the entry mode to value
Setting example	:GNG:MODE PERC Sets the entry mode to %.
Query syntax	[:CONFigure]:GNG:MODE?
Return parameter	Percent Value Returns the Setting value of Go-NoGo input mode, by the string.
Query example	:GNG:MODE? >Percent The entry mode is %.
Related commands	[:CONFigure]:GNG:H [:CONFigure]:GNG:L [:CONFigure]:GNG:C

Set →

→ Query

4-6-19. [:CONFigure]:GNG:H

Description	Setting and query for the high voltage/current limit value. If the entry mode is set to value, the high voltage/current limit value units are in volts/amps. If the entry mode is set to percent, the high voltage/current limit value units are in percent.
Setting syntax	[:CONFigure]:GNG:H <NRf>
Setting parameter	<NRf> Sets the high voltage/current limit value in volts/amps or in percent.
Setting example	:GNG:H 100.0 Sets the high voltage limit value to 100%.
Query syntax	[:CONFigure]:GNG:H?
Return parameter	<NR2> Returns the voltage/current upper limit value, by the string.
Query example	:GNG:H? >100.0 Returns the high voltage limit value as 100%.
Related commands	[:CONFigure]:GNG:Mode [:CONFigure]:GNG:L

Set →
 → Query

4-6-20. [:CONFigure]:GNG:L

Description	Setting and query for the low voltage/current limit value. If the entry mode is set to value, the low voltage/current limit value units are in volts/amps. If the entry mode is set to percent, the low voltage/current limit value units are in percent.
Setting syntax	[:CONFigure]:GNG:L <NRf>
Setting parameter	<NRf> Sets the low voltage/current limit value in volts/amps or in percent.
Setting example	:GNG:L 10.0 Sets the low voltage limit value to 10%.
Query syntax	[:CONFigure]:GNG:L?
Return parameter	<NR2> Returns the voltage/current lower limit value, by the string.
Query example	:GNG:L? >10.0 Returns the low voltage limit value as 10%.
Related commands	[:CONFigure]:GNG:Mode [:CONFigure]:GNG:H

Set →
 → Query

4-6-21. [:CONFigure]:GNG:C

Description	Setting and query for the center voltage/current limit value. The center voltage limit value is used as the center reference value when the entry mode is set to percent.
Setting syntax	[:CONFigure]:GNG:C <NRf>
Setting parameter	<NRf> Sets the center voltage/current limit value in volts/amps.
Setting example	:GNG:C 10.0 Sets the center voltage/current limit value to 10V or 10A.
Query syntax	[:CONFigure]:GNG:C?
Return parameter	<NR2> Returns the Center value of voltage/current, by the string.
Query example	:GNG:C? >10.0 Returns the center voltage/current limit value of 10V or 10A.
Related commands	[:CONFigure]:GNG:Mode

Set →
 → Query

4-6-22. [:CONFigure]:GNG:DTIME

Description	Setting and query for the Go-NoGo delay time.	
Setting syntax	[:CONFigure]:GNG:DTIME {<NRf> MINimum MAXimum}	
Setting parameter	<NRf>	Sets the Go-NoGo delay time in seconds (0.0~1.0) with 0.1 second resolution. The unit is [s].
	MINimum	Minimum delay time
	MAXimum	Maximum delay time
Setting example	:GNG:DTIM 0.5 Sets the delay time to 0.5 seconds.	
Query syntax	[:CONFigure]:GNG:DTIME?	
Return parameter	<NR2>	Returns the delay time in seconds, by the string.
Query example	:GNG:DTIM? >0.5 The delay time is 0.5 seconds.	

Set →
 → Query

4-6-23. [:CONFigure]:GNG:SPECTest

Description	Setting and query for the Go-NoGo testing.	
Setting syntax	[:CONFigure]:GNG:SPECTest {OFF ON}	
Setting parameter	OFF	SPEC test = OFF
	ON	SPEC test = ON
Setting example	:GNG:SPECT ON Turns Go-NoGo testing on.	
Query syntax	[:CONFigure]:GNG:SPECTest?	
Return parameter	ON OFF	Return the Go-NoGo testing.
Query example	:GNG:SPECT? >OFF Indicates that Go-NoGo testing is off.	

4-6-24. [:CONFigure]:GNG[:PASS]

→ Query

Description	Queries the Go-NoGo test result(s). This command can be used for all test modes (CC, CV, CR, CP).
Query syntax	[:CONFigure]:GNG[:PASS]?
Return parameter	Returns the Go-NoGo test result.
	NG No Good (Fail)
	GO Good (Pass)
Query example	:GNG? >GO The Go-NoGo test result is Pass.

4-7. Parallel Commands

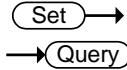

4-7-1. [:CONFigure]:PARAllel

Description	Configures the unit for parallel operation, or queries its state. This command configures the unit as a Master or Slave, and configures how many slave units are connected if the unit is configured as a master.	
Setting syntax	[:CONFigure]:PARAllel { MASTer SLAVe OFF P2 P3 P4 P5 B1 B2 B3 B4}	
Setting parameter	MASTer	Sets the unit to Master
	SLAVe	Sets the unit to Slave
	OFF	Turn parallel mode off
	P2 P3 P4 P5	Number of connected slaves
	B1 B2 B3 B4	Number of connected Booster.
Setting example 1	:PAR MAST Sets the unit to Master.	
Setting example 2	:PAR B2 Configures the unit for use with 2 booster units.	
Query syntax	[:CONFigure]:PARAllel?	
Return parameter	Return the connections number and mode(master / slave).	
	Mode:Master, Number:OFF Parallel Number:{2 3 4 5} Booster Number: {1 2 3 4}	Response of master mode
	Mode:Slave	Response of Slave mode
Query example	:PAR? >Mode:Master, Number:OFF The unit is set to Master and there are no connected slaves.	

4-8. Step Commands

→ Set

4-8-1. :CONFigure:STATus

→ Query

Description	Sets the mode used for the set resolution when using the scroll wheel to edit parameters.	
Setting syntax	:CONFigure:STATus {STEP CURSOR}	
Setting parameter	STEP	Knob Status = Step (coarse/fine)
	CURSOR	Knob Status = Cursor
Setting example	:CONF:STAT STEP Sets the mode to STEP.	
Query syntax	:CONFigure:STATus?	
Return parameter	STEP CURSOR	Returns the Knob Status configuration as a string.
Query example	:CONF:STAT? >Step The Knob Status configuration is STEP mode.	

4-8-2. [:CONFigure]:STEP:CC

→ Query

Description	Queries the step resolution for each CC Mode range.	
Query syntax	[:CONFigure]:STEP:CC?	
Return parameter	Returns the step resolution for each CC Mode range, by the string. Unit is [A]	
	CCH:<NR2>	The step resolution for CC Mode H range.
	CCM:<NR2>	The step resolution for CC Mode M range.
	CCL:<NR2>	The step resolution for CC Mode L range.
Query example	:STEP:CC? >CCH:0.0300, CCM:0.00300, CCL:0.000300 The CC mode step resolution for each range are H range: 30mA, M range: 3mA, L range: 0.3mA.	





4-8-3. [:CONFigure]:STEP:CCH

Description	Setting and query for the step resolution for CC High Range. Note: The step resolution setting will be automatically rounded to the closest multiple of the base resolution.						
Setting syntax	[:CONFigure]:STEP:CCH {<NRf> MINimum MAXimum}						
Setting parameter	<table border="1"> <tr> <td><NRf></td> <td>Step resolution. Unit is [A]</td> </tr> <tr> <td>MINimum</td> <td>Minimum step resolution</td> </tr> <tr> <td>MAXimum</td> <td>Maximum step resolution</td> </tr> </table>	<NRf>	Step resolution. Unit is [A]	MINimum	Minimum step resolution	MAXimum	Maximum step resolution
<NRf>	Step resolution. Unit is [A]						
MINimum	Minimum step resolution						
MAXimum	Maximum step resolution						
Setting example	:STEP:CCH 0.03A Sets the step resolution to 30mA.						
Query syntax	[:CONFigure]:STEP:CCH?						
Return parameter	CCH:<NR2> Returns the range and the step resolution, by the string.						
Query example	:STEP:CCH? >CCH:0.0300 The step resolution of CC H range is 30mA.						

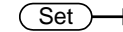



4-8-4. [:CONFigure]:STEP:CCM

Description	Setting and query for the step resolution for CC medium Range. Note: The step resolution setting will be automatically rounded to the closest multiple of the base resolution.						
Setting syntax	[:CONFigure]:STEP:CCM {<NRf> MINimum MAXimum}						
Setting parameter	<table border="1"> <tr> <td><NRf></td> <td>Step resolution. Unit is [A]</td> </tr> <tr> <td>MINimum</td> <td>Minimum step resolution</td> </tr> <tr> <td>MAXimum</td> <td>Maximum step resolution</td> </tr> </table>	<NRf>	Step resolution. Unit is [A]	MINimum	Minimum step resolution	MAXimum	Maximum step resolution
<NRf>	Step resolution. Unit is [A]						
MINimum	Minimum step resolution						
MAXimum	Maximum step resolution						
Setting example	:STEP:CCM 0.003A Sets the step resolution to 3mA.						
Query syntax	[:CONFigure]:STEP:CCM?						
Return parameter	CCM:<NR2> Returns the range and the step resolution, by the string.						
Query example	:STEP:CCM? >CCM:0.00300 The step resolution of CC M range is 3mA.						

Set →
 → Query

4-8-5. [:CONFigure]:STEP:CCL

Description	Setting and query for the step resolution for CC low Range. Note: The step resolution setting will be automatically rounded to the closest multiple of the base resolution.	
Setting syntax	[:CONFigure]:STEP:CCL {<NRf> MINimum MAXimum}	
Setting parameter	<NRf>	Step resolution. Unit is [A]
	MINimum	Minimum step resolution
	MAXimum	Maximum step resolution
Setting example	:STEP:CCL 0.0003A Sets the step resolution to 0.3mA.	
Query syntax	[:CONFigure]:STEP:CCL?	
Return parameter	CCL:<NR2>	Returns the range and the step resolution, by the string.
Query example	:STEP:CCL? > CCL:0.000300 The step resolution of CC L range is 0.3mA.	

4-8-6. [:CONFigure]:STEP:CR

→ Query

Description	Queries the step resolution for each CR Mode range.	
Query syntax	[:CONFigure]:STEP:CR?	
Return parameter	Returns the step resolution for each CR Mode range, by string. Unit is [mS]	
	CRH:<NR2>	The step resolution for CR Mode H range.
	CRM:<NR2>	The step resolution for CR Mode M range.
	CRL:<NR2>	The step resolution for CR Mode L range.
Query example	:STEP:CR? >CRH:3.00, CRM:0.300, CRL:0.0300 Returns the CR mode step resolution for each range.	

Set →

4-8-7. [:CONFigure]:STEP:CRH

→ Query

Description	Setting and query for the step resolution for CR High Range. Note: The step resolution setting will be automatically rounded to the closest multiple of the base resolution.
Setting syntax	[:CONFigure]:STEP:CRH {<NRf> MINimum MAXimum}
Setting parameter	<NRf> Step resolution. Unit is [mS] MINimum Minimum step resolution MAXimum Maximum step resolution
Setting example	:STEP:CRH 3 Sets the step resolution to 3mS.
Query syntax	[:CONFigure]:STEP:CRH?
Return parameter	CRH:<NR2> Returns the range and the step resolution, by the string.
Query example	:STEP:CRH? >CRH:3.00 Returns the step resolution (3mS).

Set →

4-8-8. [:CONFigure]:STEP:CRM

→ Query

Description	Setting and query for the step resolution for CR Medium Range. Note: The step resolution setting will be automatically rounded to the closest multiple of the base resolution.
Setting syntax	[:CONFigure]:STEP:CRM {<NRf> MINimum MAXimum}
Setting parameter	<NRf> Step resolution. Unit is [mS] MINimum Minimum step resolution MAXimum Maximum step resolution
Setting example	:STEP:CRM 0.3 Sets the step resolution to 0.3mS.
Query syntax	[:CONFigure]:STEP:CRM?
Return parameter	CRM:<NR2> Returns the range and the step resolution, by the string.
Query example	:STEP:CRM? >CRM:0.300 Returns the step resolution (0.3mS).

Set →

→ Query



4-8-9. [:CONFigure]:STEP:CRL

Description	Setting and query for the step resolution for CR Low Range. Note: The step resolution setting will be automatically rounded to the closest multiple of the base resolution.
Setting syntax	[:CONFigure]:STEP:CRL {<NRf> MINimum MAXimum}
Setting parameter	<NRf> Step resolution. Unit is [mS]
	MINimum Minimum step resolution
	MAXimum Maximum step resolution
Setting example	:STEP:CRL 0.03 Sets the step resolution to 0.03mS.
Query syntax	[:CONFigure]:STEP:CRL?
Return parameter	CRL:<NR2> Returns the range and the step resolution, by the string.
Query example	:STEP:CRL? >CRL:0.0300 Returns the step resolution (0.03mS).

4-8-10. [:CONFigure]:STEP:CV



→ Query

Description	Queries the step resolution for each CV Mode range.
Query syntax	[:CONFigure]:STEP:CV?
Return parameter	Returns the step resolution for each CV Mode range, by the string. Unit is [V]
	CVH:<NR2> The step resolution for each CV Mode H range.
	CVL:<NR2> The step resolution for each CV Mode L range.
Query example	:STEP:CV? >CVH:2.00, CVL:0.200 Returns the CV mode step resolution for each range.

 →
 → 

4-8-11. [:CONFigure]:STEP:CVH

Description	Setting and query for the step resolution for CV High Range. Note: The step resolution setting will be automatically rounded to the closest multiple of the base resolution.						
Setting syntax	[:CONFigure]:STEP:CVH {<NRf> MINimum MAXimum}						
Setting parameter	<table border="1"> <tr> <td><NRf></td> <td>Step resolution. Unit is [V]</td> </tr> <tr> <td>MINimum</td> <td>Minimum step resolution</td> </tr> <tr> <td>MAXimum</td> <td>Maximum step resolution</td> </tr> </table>	<NRf>	Step resolution. Unit is [V]	MINimum	Minimum step resolution	MAXimum	Maximum step resolution
<NRf>	Step resolution. Unit is [V]						
MINimum	Minimum step resolution						
MAXimum	Maximum step resolution						
Setting example	:STEP:CVH 2V Sets the step resolution to 2V.						
Query syntax	[:CONFigure]:STEP:CVH?						
Return parameter	CVH:<NR2> Returns the range and the step resolution, by the string.						
Query example	:STEP:CVH? > CVH:2.00 Returns the step resolution (2V).						

 →
 → 

4-8-12. [:CONFigure]:STEP:CVL

Description	Setting and query for the step resolution for CV Low Range. Note: The step resolution setting will be automatically rounded to the closest multiple of the base resolution.						
Setting syntax	[:CONFigure]:STEP:CVL {<NRf> MINimum MAXimum}						
Setting parameter	<table border="1"> <tr> <td><NRf></td> <td>Step resolution. Unit is [V]</td> </tr> <tr> <td>MINimum</td> <td>Minimum step resolution</td> </tr> <tr> <td>MAXimum</td> <td>Maximum step resolution</td> </tr> </table>	<NRf>	Step resolution. Unit is [V]	MINimum	Minimum step resolution	MAXimum	Maximum step resolution
<NRf>	Step resolution. Unit is [V]						
MINimum	Minimum step resolution						
MAXimum	Maximum step resolution						
Setting example	:STEP:CVL 0.2V Sets the step resolution to 0.2V.						
Query syntax	[:CONFigure]:STEP:CVL?						
Return parameter	CVL:<NR2> Returns the range and the step resolution, by the string.						
Query example	:STEP:CVL? > CVL:0.200 Returns the step resolution (0.2V).						

4-8-13. [:CONFigure]:STEP:CP

→ Query

Description	Queries the step resolution for each CP Mode range.
Query syntax	[:CONFigure]:STEP:CP?
Return parameter	Returns the step resolution for each CP Mode range, by the string. Unit is [W]
	CPH:<NR2> The step resolution for each CP Mode H range.
	CPM:<NR2> The step resolution for each CP Mode M range.
	CPL:<NR2> The step resolution for each CP Mode L range.
Query example	:STEP:CP? > CPH:1.00, CPM:0.100, CPL:0.0100 Returns the CP mode step resolution for each range.

4-8-14. [:CONFigure]:STEP:CPH

Set →

→ Query

Description	Setting and query for the step resolution for CP High Range. Note: The step resolution setting will be automatically rounded to the closest multiple of the base resolution.
Setting syntax	[:CONFigure]:STEP:CPH {<NRf> MINimum MAXimum}
Setting parameter	<NRf>[W] Step resolution. Unit is [W]
	MINimum Minimum step resolution
	MAXimum Maximum step resolution
Setting example	:STEP:CPH 1 Sets the step resolution to 1W.
Query syntax	[:CONFigure]:STEP:CPH?
Return parameter	CPH:<NR2> Returns the range and the step resolution, by the string.
Query example	:STEP:CPH? >CPH:1.00 Returns the step resolution (1W).





4-8-15. [:CONFigure]:STEP:CPM

Description	Setting and query for the step resolution for CP Medium Range. Note: The step resolution setting will be automatically rounded to the closest multiple of the base resolution.						
Setting syntax	[:CONFigure]:STEP:CPM {<NRf> MINimum MAXimum}						
Setting parameter	<table border="1"> <tr> <td><NRf></td> <td>Step resolution. Unit is [W]</td> </tr> <tr> <td>MINimum</td> <td>Minimum step resolution</td> </tr> <tr> <td>MAXimum</td> <td>Maximum step resolution</td> </tr> </table>	<NRf>	Step resolution. Unit is [W]	MINimum	Minimum step resolution	MAXimum	Maximum step resolution
<NRf>	Step resolution. Unit is [W]						
MINimum	Minimum step resolution						
MAXimum	Maximum step resolution						
Setting example	:STEP:CPM 0.1 Sets the step resolution to 0.1W.						
Query syntax	[:CONFigure]:STEP:CPM?						
Return parameter	CPM:<NR2> Returns the range and the step resolution, by the string.						
Query example	:STEP:CPM? >CPM:0.100 Returns the step resolution (0.1W).						



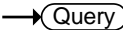

4-8-16. [:CONFigure]:STEP:CPL

Description	Setting and query for the step resolution for CP Low Range. Note: The step resolution setting will be automatically rounded to the closest multiple of the base resolution.						
Setting syntax	[:CONFigure]:STEP:CPL {<NRf> MINimum MAXimum}						
Setting parameter	<table border="1"> <tr> <td><NRf></td> <td>Step resolution. Unit is [W]</td> </tr> <tr> <td>MINimum</td> <td>Minimum step resolution</td> </tr> <tr> <td>MAXimum</td> <td>Maximum step resolution</td> </tr> </table>	<NRf>	Step resolution. Unit is [W]	MINimum	Minimum step resolution	MAXimum	Maximum step resolution
<NRf>	Step resolution. Unit is [W]						
MINimum	Minimum step resolution						
MAXimum	Maximum step resolution						
Setting example	:STEP:CPL 0.01 Sets the step resolution to 0.01W.						
Query syntax	[:CONFigure]:STEP:CPL?						
Return parameter	CPL:<NR2> Returns the range and the step resolution, by the string.						
Query example	:STEP:CPL? >CPM:0.0100 Returns the step resolution (0.01W).						

4-9. External Control Commands

Set →

4-9-1. [:CONFigure]:EXTErnal[:CONTRol]

→ Query

Description	Setting and query for the external control of CC, CR, CV, CP mode.	
Setting syntax	[:CONFi gure]:EXTErnal[:CONTRol] {OFF VOLTage RESistance RINV}	
Setting parameter	OFF	Disables external control
	VOLTage	Sets the unit to external voltage control
	RESistance	Sets the unit to external resistance control
	RINV	Sets the unit to external resistance (inverted) control
Setting example	:EXT OFF Turns external control off.	
Query syntax	[:CONFi gure]:EXTErnal[:CONTRol] ?	
Return parameter	Control: OFF Volt Res Rinverse	Returns mode of the external control, by the string.
Query example	:EXT? >Control:OFF External control is setting is off.	

Set →

4-9-2. [:CONFigure]:EXTErnal:CV

→ Query

Description	Setting and query for the external control of +CV mode. Note: Please set the unit to external control of CC, CR, CV, CP mode.	
Setting syntax	[:CONFigure]:EXTErnal:CV {OFF ON}	
Setting parameter	OFF	Disables external control of +CV mode
	ON	Sets the unit to external control of +CV mode
Setting example	:EXT:CV ON Turns external control of +CV mode on.	
Query syntax	[:CONFigure]:EXTErnal:CV?	
Return parameter	CV:OFF ON	Returns the external control of +CV mode configuration, by the string.
Query example	:EXT:CV? >CV:ON Uses external control of +CV mode.	

4-9-3. [:CONFigure]:EXTeRnal:LOADonin

Description	Setting and query for turned on and off with the external switch. External switch (LoadOn IN) is whether or not turned on the load setting of at the time of the open (HIGH) or closed (LOW).	
Setting syntax	[:CONFigure]:EXTeRnal:LOADonin {OFF High Low}	
Setting parameter	OFF	LoadOn IN = off
	HIGH	LoadOn IN = open
	LOW	LoadOn IN = closed
Setting example	:EXT:LOAD OFF Turns The LoadOn IN off.	
Query syntax	[:CONFigure]:EXTeRnal:LOADonin?	
Return parameter	LoadOn In: OFF High Low	Returns the setting value of external switch, by the string.
Query example	: EXT:LOAD? >LoadOn In:OFF The LoadOn In setting is off.	

4-10. Mode Subsystem Commands

Set →

4-10-1. :MODE

→ Query

Description	Setting and query for the operating modes.	
Setting syntax	:MODE {CC CR CV CP CCCV CRCV CPCV}	
Setting parameter	CC	CC mode
	CR	CR mode
	CV	CV mode
	CP	CP mode
	CCCV	CC + CV mode
	CRCV	CR + CV mode
	CPCV	CP + CV mode
Setting example	:MODE CC Sets the mode to CC mode.	
Query syntax	:MODE?	
Return parameter	CC CR CV CP CCCV CRCV CPCV	Returns the operating modes, by the string.
Query example	:MODE? >CC Returns the operating mode (CC mode).	

Set →

4-10-2. [:MODE]:CRANge

→ Query

Description	Setting and query for the current range of all the operating modes.	
Setting syntax	[:MODE]:CRANge {HIGH MIDDLE LOW}	
Setting parameter	HIGH	High range
	MIDDLE	Middle range
	LOW	Low range
Setting example	:CRAN LOW Sets the current range to Low.	
Query syntax	[:MODE]:CRANge?	
Return parameter	High Mid Low	Returns the setting of Setting of the current range, by the string.
Query example	:CRAN? >Low The current range is set to Low.	

Set →

→ Query

4-10-3. [:MODE]:VRANge

Description	Setting and query for the voltage range of all operating modes.	
Setting syntax	[:MODE]:VRANge {HIGH LOW}	
Setting parameter	HIGH	High range
	LOW	Low range
Setting example	:VRAN LOW Sets the voltage range to Low.	
Query syntax	[:MODE]:VRANge?	
Return parameter	High Low	Returns the setting of Setting of the voltage range, by the string.
Query example	:VRAN? >Low The voltage range is set to Low.	

Set →

→ Query

4-10-4. [:MODE]:RESPonse

Description	Setting and query for The response speed of the CV and +CV mode. The default is fast response.	
Setting syntax	[:MODE]:RESPonse {FAST RESP{6 5 4 3 2 1} SLOW}	
Setting parameter	FAST	Response speed is FAST
	RESP6	Response speed is 6
	RESP5	Response speed is 5
	RESP4	Response speed is 4
	RESP3	Response speed is 3
	RESP2	Response speed is 2
	RESP1	Response speed is 1
	SLOW	Response speed is SLOW
Setting example	:RESP FAST Sets the CV and +CV response to fast.	
Query syntax	[:MODE]:RESPonse?	
Return parameter	FAST RESP6 RESP5 RESP4 RESP3 RESP2 RESP1 SLOW	Returns the response speed.
Query example	:RESP? >FAST The speed response of CV and +CV mode is set to fast.	

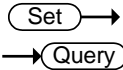

4-10-5. [:MODE]:DYNamic

Description	Setting and query for the Switching function.	
Setting syntax	[:MODE]:DYNamic {DYNamic STATic}	
Setting parameter	DYNamic	Set to Dynamic mode
	STATic	Set to Static mode
Setting example	:DYN DYN	
	Set the switching function to dynamic	
Query syntax	[:MODE]:DYNamic?	
Return parameter	Dynamic Static	Returns the Setting of Switching function, by the string.
Query example	:DYN?	
	>Dynamic	
	The switching function is set to dynamic mode.	

4-11. Current Subsystem Commands

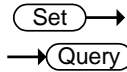

4-11-1. :CURRent[:VA]

Description	Setting and query for the "A Value" current of the CC static mode. Note: A different current value can be set for each current range (High/Mid/Low). Note: The [:VA] node can only be omitted when in static mode.
Setting syntax	:CURRent[:VA] {<NRf> MINimum MAXimum}
Setting parameter	<NRf> "A Value" current value. Unit is [A] MINimum Minimum current level MAXimum Maximum current level
Setting example	:CURR MIN Sets the current value to the minimum.
Query syntax	:CURRent[:VA]?
Return parameter	<NR2> Return the current value of "A Value", by the string.
Query example	:CURR? >1.0000 Current setting of "A Value" is set to 1A.

4-11-2. :CURRent[:VA]:TRIGgered

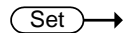

Description	Set the current value when the trigger is activated.
Setting syntax	:CURRent[:VA]:TRIGgered {<NR2> MINimum MAXimum }
Setting parameter	<NRf> "A Value" current value. Unit is [A] MINimum Minimum current level MAXimum Maximum current level
Setting example	:CURR:TRIG MIN Set the minimum current value when the trigger is activated.
Related commands	*TRG, :INITiate:CONTinuous, :INITiate[:IMMEDIATE]

Set →
 → Query

4-11-3. :CURRent:VB

Description	Setting and query for the "B Value" current of the CC static mode. Note: A different current value can be set for each current range (High/Mid/Low).						
Setting syntax	:CURRent:VB {<NRf> MINimum MAXimum}						
Setting parameter	<table border="1" style="width: 100%;"> <tr> <td style="background-color: #e0e0e0;"><NRf>[A]</td> <td>"B Value" current value. Unit is [A]</td> </tr> <tr> <td style="background-color: #e0e0e0;">MINimum</td> <td>Minimum current level</td> </tr> <tr> <td style="background-color: #e0e0e0;">MAXimum</td> <td>Maximum current level</td> </tr> </table>	<NRf>[A]	"B Value" current value. Unit is [A]	MINimum	Minimum current level	MAXimum	Maximum current level
<NRf>[A]	"B Value" current value. Unit is [A]						
MINimum	Minimum current level						
MAXimum	Maximum current level						
Setting example	:CURR:VB MIN Sets the current value to the minimum.						
Query syntax	:CURRent:VB?						
Return parameter	<table border="1" style="width: 100%;"> <tr> <td style="background-color: #e0e0e0;"><NR2></td> <td>Return the Current value of "B Value", by the string.</td> </tr> </table>	<NR2>	Return the Current value of "B Value", by the string.				
<NR2>	Return the Current value of "B Value", by the string.						
Query example	:CURR:VB? >1.0000 Current setting of "B Value" is set to 1A.						

Set →
 → Query

4-11-4. :CURRent:SRATe

Description	Setting and query for the current slew rate of CC static mode.						
Setting syntax	:CURRent:SRATe {<NRf> MINimum MAXimum}						
Setting parameter	<table border="1" style="width: 100%;"> <tr> <td style="background-color: #e0e0e0;"><NRf></td> <td>Sets the slew rate in mA/us</td> </tr> <tr> <td style="background-color: #e0e0e0;">MINimum</td> <td>Set to the lowest slew rate</td> </tr> <tr> <td style="background-color: #e0e0e0;">MAXimum</td> <td>Set to the highest slew rate</td> </tr> </table>	<NRf>	Sets the slew rate in mA/us	MINimum	Set to the lowest slew rate	MAXimum	Set to the highest slew rate
<NRf>	Sets the slew rate in mA/us						
MINimum	Set to the lowest slew rate						
MAXimum	Set to the highest slew rate						
Setting example	:CURR:SRAT MIN Sets the slew rate to the minimum.						
Query syntax	:CURRent:SRATe?						
Return parameter	<table border="1" style="width: 100%;"> <tr> <td style="background-color: #e0e0e0;"><NR2></td> <td>Return the slew rate, by the string.</td> </tr> </table>	<NR2>	Return the slew rate, by the string.				
<NR2>	Return the slew rate, by the string.						
Query example	:CURR:SRAT? >5.0000 The slew rate is set to 5mA/us.						

Set →
 → Query

4-11-5. :CURRent:L1

Description	Setting and query for the "Level1" current of the CC dynamic mode. This command applies in "Dyna.Level" is "Value". Note: A different current value can be set for each range (High/Mid/Low).						
Setting syntax	:CURRent:L1 {<NRf> MINimum MAXimum}						
Setting parameter	<table border="1" style="width: 100%;"> <tr> <td style="width: 15%;"><NRf></td> <td>"Level1" current value. Unit is [A]</td> </tr> <tr> <td>MINimum</td> <td>Minimum current level</td> </tr> <tr> <td>MAXimum</td> <td>Maximum current level</td> </tr> </table>	<NRf>	"Level1" current value. Unit is [A]	MINimum	Minimum current level	MAXimum	Maximum current level
<NRf>	"Level1" current value. Unit is [A]						
MINimum	Minimum current level						
MAXimum	Maximum current level						
Setting example	:CURR:L1 MIN Sets the current value to the minimum.						
Query syntax	:CURRent:L1?						
Return parameter	<table border="1" style="width: 100%;"> <tr> <td style="width: 15%;"><NR2></td> <td>Return the current value of "Level1", by the string.</td> </tr> </table>	<NR2>	Return the current value of "Level1", by the string.				
<NR2>	Return the current value of "Level1", by the string.						
Query example	:CURR:L1? >1.0000 Current setting of " Level1" is set to 1A.						

Set →
 → Query

4-11-6. :CURRent:L2

Description	Setting and query for the "Level2" current of the CC dynamic mode. This command applies in "Dyna.Level" is "Value". Note: A different current value can be set for each range (High/Mid/Low).						
Setting syntax	:CURRent:L2 {<NRf> MINimum MAXimum}						
Setting parameter	<table border="1" style="width: 100%;"> <tr> <td style="width: 15%;"><NRf></td> <td>"Level2" current value. Unit is [A]</td> </tr> <tr> <td>MINimum</td> <td>Minimum current level</td> </tr> <tr> <td>MAXimum</td> <td>Maximum current level</td> </tr> </table>	<NRf>	"Level2" current value. Unit is [A]	MINimum	Minimum current level	MAXimum	Maximum current level
<NRf>	"Level2" current value. Unit is [A]						
MINimum	Minimum current level						
MAXimum	Maximum current level						
Setting example	:CURR:L2 MIN Sets the current value to the minimum.						
Query syntax	:CURRent:L2?						
Return parameter	<table border="1" style="width: 100%;"> <tr> <td style="width: 15%;"><NR2></td> <td>Return the current value of "Level2", by the string.</td> </tr> </table>	<NR2>	Return the current value of "Level2", by the string.				
<NR2>	Return the current value of "Level2", by the string.						
Query example	:CURR:L2? >1.0000 Current setting of " Level2" is set to 1A.						

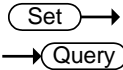

4-11-7. :CURRent:SET

Description	Setting and query for the "Set" current of the CC dynamic mode. This command applies in "Dyna.Level" is "Percent".	
Setting syntax	:CURRent:SET{<NRf> MINimum MAXimum}	
Setting parameter	<NRf>	The current value at the time of "Level=100%". Unit is [A]
	MINimum	Minimum current value
	MAXimum	Maximum current value
Setting example	:CURR:SET MIN Sets the minimum current value of "Level = 100%".	
Query syntax	:CURRent:SET?	
Return parameter	<NR2>	Return the current value of "Level = 100%", by the string.
Query example	:CURR:SET? >1.0 Current value of "Level = 100%" is set to 1A.	
Related commands	:CURRent:LEVel	

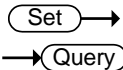

4-11-8. :CURRent:LEVel

Description	Setting and query for the "Level" % of the CC dynamic mode. This command applies in "Dyna.Level" is "Percent".	
Setting syntax	:CURRent:LEVel {<NRf> MINimum MAXimum}	
Setting parameter	<NRf>	% of "SET" current level (unit is [%])
	MINimum	Minimum % of "SET" current level
	MAXimum	Maximum % of "SET" current level
Setting example	:CURR:LEV MIN Sets the % level current value to the minimum.	
Query syntax	:CURRent:LEVel?	
Return parameter	<NR2>	Return the current of "% Level", by the string.
Query example	:CURR:LEV? >50 Percentage of the set current value is set to 50%.	
Related commands	:CURRent:SET	

Set →
 → Query

4-11-9. :CURRent:RISE

Description	Setting and query for the rising current slew rate of the CC dynamic mode.	
Setting syntax	:CURRent:RISE {<NRf> MINimum MAXimum}	
Setting parameter	<NRf>	Rising current slew rate (unit is [mA/us]).
	MINimum	Minimum slew rate
	MAXimum	Maximum slew rate
Setting example	:CURR:RISE MIN Sets the rising slew rate to the minimum.	
Query syntax	:CURRent:RISE?	
Return parameter	<NR2>	Return the rise of the current slew rate, by the string.
Query example	:CURR:RISE? >5000 Returns the rising slew rate as 5000mA/us.	
Related commands	:CURRent:FALL	

Set →
 → Query

4-11-10. :CURRent:FALL

Description	Setting and query for the falling of the current slew rate of the CC dynamic mode.	
Setting syntax	:CURRent:FALL {<NRf> MINimum MAXimum}	
Setting parameter	<NRf>	Falling current slew rate (unit is [mA/us]).
	MINimum	Minimum slew rate
	MAXimum	Maximum slew rate
Setting example	:CURR:FALL MIN Sets the falling slew rate to the minimum.	
Query syntax	:CURRent:FALL?	
Return parameter	<NR2>	Return the falling of the current slew rate, by the string.
Query example	:CURR:FALL? >5000 Returns the falling slew rate as 5000mA/us.	
Related commands	:CURRent:RISE	





4-11-11. :CURRent:T1

Description	Setting and query for the “Timer1” time of CC dynamic mode. This command applies in “Dyna.Time” is “T1/T2”.	
Setting syntax	:CURRent:T1 {<NRf> MINimum MAXimum}	
Setting parameter	<NRf>	T1 timer setting. (unit is seconds)
	MINimum	Minimum time
	MAXimum	Maximum time
Setting example	:CURR:T1 0.2 Sets the setting of the timer T1.	
Query syntax	:CURRent:T1?	
Return parameter	<NR2>	Return the setting of the timer T1, by the string.
Query example	:CURR:T1? >0.2 Return the setting of the timer T1.	
Related commands	:CURRent:T2	





4-11-12. :CURRent:T2

Description	Setting and query for the “Timer2” time of CC dynamic mode. This command applies in “Dyna.Time” is “T1/T2”.	
Setting syntax	:CURRent:T2 {<NRf> MINimum MAXimum}	
Setting parameter	<NRf>	T2 timer setting. (unit is seconds)
	MINimum	Minimum time
	MAXimum	Maximum time
Setting example	:CURR:T2 0.2 Sets the setting of the timer T2.	
Query syntax	:CURRent:T2?	
Return parameter	<NR2>	Return the setting of the timer T2, by the string.
Query example	:CURR:T2? >0.2 Returns the setting of the timer T2.	
Related commands	:CURRent:T1	

Set →
 → Query

4-11-13. :CURRent:FREQUency

Description	Setting and query for “Frequency” value of the CC dynamic mode. This command applies in “Dyna.Time” is “Freq/Duty”.	
Setting syntax	:CURRent:FREQUency {<NRf> MINimum MAXimum}	
Setting parameter	<NRf>	Sets the switching frequency.(unit is Hz)
	MINimum	Minimum frequency
	MAXimum	Maximum frequency
Setting example	:CURR:FREQ 60 Sets frequency to 60Hz.	
Query syntax	:CURRent:FREQUency?	
Return parameter	<NR2>	Return the switching frequency, by the string.
Query example	:CURR:FREQ? >60 Returns the switching frequency as 60Hz.	
Related commands	:CURRent:DUTY	

Set →
 → Query

4-11-14. :CURRent:DUTY

Description	Setting and query for “Duty” % of the CC dynamic mode. This command applies in “Dyna.Time” is “Freq/Duty”.	
Setting syntax	:CURRent:DUTY {<NRf> MINimum MAXimum}	
Setting parameter	<NRf>	Sets the duty cycle as a percentage.
	MINimum	Minimum duty cycle
	MAXimum	Maximum duty cycle
Setting example	:CURR:DUTY 50 Sets the duty cycle 50%.	
Query syntax	:CURRent:DUTY?	
Return parameter	<NR2>	Return the duty cycle of positive, by the string.
Query example	:CURR:DUTY? >50 Returns the duty cycle as 50%.	
Related commands	:CURRent:FREQUency	

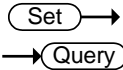

4-11-15. :CURRENT:RECall

Description	Sets or queries whether A Value or B Value is the currently active value in CC static mode.
Setting syntax	:CURRENT:RECall {<Boolean> A B}
Setting parameter	A 0 CC active setting = A value
	B 1 CC active setting = B value
Setting example	:CURR:REC A Sets A value of CC setting mode to active.
Query syntax	:CURRENT:RECall?
Return parameter	Return the currently active value in CC static mode
	0 CC active setting = A value
	1 CC active setting = B value
Query example	:CURR:REC? >0 Return the CC active setting is A value.

4-12. Resistance Subsystem Commands

Set →

4-12-1. :RESistance[:VA]

→ Query

Description	Setting and query for the "A Value" resistance of the CR static mode. Note: A different value can be set for each current range (High/Mid/Low). Note: The optional command node [:VA] can only be omitted when in static mode.
Setting syntax	:RESistance[:VA] {<NRf> MINimum MAXimum}
Setting parameter	<NRf> "A Value" resistance value. Unit is [Ω].
	MINimum Minimum resistance level
	MAXimum Maximum resistance level
Setting example	:RES:VA MIN Sets the resistance value to the minimum.
Query syntax	:RESistance[:VA]?
Return parameter	<NR2> Return the resistance value of "A Value", by the string.
Query example	:RES:VA? >9.840 Return the resistance value (9.84Ω) of "A Value".

4-12-2. :RESistance[:VA]:TRIGgered

Set →

Description	Set the resistance value when the trigger is activated.
Setting syntax	:RESistance[:VA]:TRIGgered {<NRf> MINimum MAXimum }
Setting parameter	<NRf> "A Value" resistance value. Unit is [Ω].
	MINimum Minimum resistance level
	MAXimum Maximum resistance level
Setting example	:RES:TRIG MIN Set the minimum resistance value when the trigger is activated.
Related commands	*TRG, :INITiate:CONTinuous, :INITiate[:IMMEDIATE]

Set →
 → Query

4-12-3. :RESistance:VB

Description	Setting and query for the "B Value" resistance of the CR static mode. Note: A different value can be set for each current range (High/Mid/Low).						
Setting syntax	:RESistance:VB {<NRf> MINimum MAXimum}						
Setting parameter	<table border="1" style="width: 100%;"> <tr> <td style="background-color: #e0e0e0;"><NRf></td> <td>"B Value" resistance value. Unit is [Ω].</td> </tr> <tr> <td style="background-color: #e0e0e0;">MINimum</td> <td>Minimum resistance level</td> </tr> <tr> <td style="background-color: #e0e0e0;">MAXimum</td> <td>Maximum resistance level</td> </tr> </table>	<NRf>	"B Value" resistance value. Unit is [Ω].	MINimum	Minimum resistance level	MAXimum	Maximum resistance level
<NRf>	"B Value" resistance value. Unit is [Ω].						
MINimum	Minimum resistance level						
MAXimum	Maximum resistance level						
Setting example	:RES:VB MIN Sets the resistance value to the minimum.						
Query syntax	:RESistance:VB?						
Return parameter	<table border="1" style="width: 100%;"> <tr> <td style="background-color: #e0e0e0;"><NR2></td> <td>Return the resistance value of "B Value", by the string.</td> </tr> </table>	<NR2>	Return the resistance value of "B Value", by the string.				
<NR2>	Return the resistance value of "B Value", by the string.						
Query example	:RES:VB? >9.840 Return the resistance value (9.84Ω) of "B Value".						

Set →
 → Query

4-12-4. :RESistance:SRATe

Description	Setting and query for the current slew rate of CR static mode.						
Setting syntax	:RESistance:SRATe {<NRf> MINimum MAXimum}						
Setting parameter	<table border="1" style="width: 100%;"> <tr> <td style="background-color: #e0e0e0;"><NRf></td> <td>Sets the slew rate in mA/us</td> </tr> <tr> <td style="background-color: #e0e0e0;">MINimum</td> <td>Set to the lowest slew rate</td> </tr> <tr> <td style="background-color: #e0e0e0;">MAXimum</td> <td>Set to the highest slew rate</td> </tr> </table>	<NRf>	Sets the slew rate in mA/us	MINimum	Set to the lowest slew rate	MAXimum	Set to the highest slew rate
<NRf>	Sets the slew rate in mA/us						
MINimum	Set to the lowest slew rate						
MAXimum	Set to the highest slew rate						
Setting example	:RES:SRAT MIN Sets the slew rate to the minimum.						
Query syntax	:RESistance:SRATe?						
Return parameter	<table border="1" style="width: 100%;"> <tr> <td style="background-color: #e0e0e0;"><NR2></td> <td>Return the slew rate, by the string.</td> </tr> </table>	<NR2>	Return the slew rate, by the string.				
<NR2>	Return the slew rate, by the string.						
Query example	:RES:SRAT? >5.0000 The slew rate is 5mA/us.						

Set →

→ Query

4-12-5. :RESistance:L1

Description	Setting and query for the "Level1" resistance of the CR dynamic mode. This command applies in "Dyna.Level" is "Value". Note: A different value can be set for each current range (High/Mid/Low).
Setting syntax	:RESistance:L1 {<NRf> MINimum MAXimum}
Setting parameter	<NRf> "level1" resistance value. Unit is [Ω]. MINimum Minimum resistance level MAXimum Maximum resistance level
Setting example	:RES:L1 MIN Sets the resistance value to the minimum.
Query syntax	:RESistance:L1?
Return parameter	<NR2> Return the resistance value of "Level1", by the string.
Query example	:RES:L1? >9.840 Return the resistance value (9.48Ω) of "Level1".

Set →

→ Query

4-12-6. :RESistance:L2

Description	Setting and query for the "Level2" resistance of the CR dynamic mode. This command applies in "Dyna.Level" is "Value". Note: A different value can be set for each current range (High/Mid/Low).
Setting syntax	:RESistance:L2 {<NRf> MINimum MAXimum}
Setting parameter	<NRf> "level2" resistance value. Unit is [Ω]. MINimum Minimum resistance level MAXimum Maximum resistance level
Setting example	:RES:L2 MIN Sets the resistance value to the minimum.
Query syntax	:RESistance:L2?
Return parameter	<NR2> Return the resistance value of "Level2", by the string.
Query example	:RES:L2? >9.840 Return the resistance value (9.48Ω) of "Level2".

4-12-7. :RESistance:SET

Description	Setting and query for the "Set" resistance of the CR dynamic mode. This command applies in "Dyna.Level" is "Percent".	
Setting syntax	:RESistance:SET {<NRf> MINimum MAXimum}	
Setting parameter	<NRf>	"The resistance value at the time of "Level=100%". Unit is [Ω].
	MINimum	Minimum resistance value
	MAXimum	Maximum resistance value
Setting example	:RES:SET MIN Sets the minimum resistance value of "Level = 100%".	
Query syntax	:RESistance:SET?	
Return parameter	<NR2>	Return the resistance value of "Level = 100%", by the string.
Query example	:RES:SET? >9.840 Return the resistance value (Ω) of "Level = 100%".	

4-12-8. :RESistance:LEVel

Description	Setting and query for the "Level" % (percentage of the Set conductance value) of the CR dynamic mode. This command applies in "Dyna.Level" is "Percent".	
Setting syntax	:RESistance:LEVel {<NRf> MINimum MAXimum}	
Setting parameter	<NRf>	% of "Set" value level (unit is %).
	MINimum	Minimum % of "Set" conductance level
	MAXimum	Maximum % of "Set" conductance level
Setting example	:RES:LEV MIN Sets the % level Millisiemens value to the minimum.	
Query syntax	:RESistance:LEVel?	
Return parameter	<NR2>	Return the Millisiemens of "% Level", by the string.
Query example	:RES:LEV? >50 Return the Millisiemens of "50% Level".	
Related commands	:RESistance:SET	

Set →
 → Query

4-12-9. :RESistance:RISE

Description	Setting and query for the rising current slew rate of the CR dynamic mode.	
Setting syntax	:RESistance:RISE {<NRf> MINimum MAXimum}	
Setting parameter	<NRf>	Rising current slew rate (unit is [mA/us]).
	MINimum	Minimum slew rate
	MAXimum	Maximum slew rate
Setting example	:RES:RISE MIN Sets the rising slew rate to the minimum.	
Query syntax	:RESistance:RISE?	
Return parameter	<NR2>	Return the rise of the slew rate, by the string.
Query example	:RES:RISE? >50.000 The rise of the slew rate is 50mA/us.	
Related commands	:RESistance:FALL	

Set →
 → Query

4-12-10. :RESistance:FALL

Description	Setting and query for the falling current slew rate of the CR dynamic mode.	
Setting syntax	:RESistance:FALL {<NRf> MINimum MAXimum}	
Setting parameter	<NRf>	Falling slew rate (unit is [mA/us]).
	MINimum	Minimum slew rate
	MAXimum	Maximum slew rate
Setting example	:RES:FALL MIN Sets the falling slew rate to the minimum.	
Query syntax	:RESistance:FALL?	
Return parameter	<NR2>	Return the falling of the conductance slew rate, by the string.
Query example	:RES:FALL? >50.000 The falling of the slew rate is 50 mA/us.	
Related commands	:RESistance:RISE	

Set →
 → Query

4-12-11. :RESistance:T1

Description	Setting and query for the “Timer1” time of CR dynamic mode. This command applies in “Dyna.Time” is “T1/T2”.	
Setting syntax	:RESistance:T1 {<NRf> MINimum MAXimum}	
Setting parameter	<NRf>	T1 timer setting. (unit is seconds)
	MINimum	Minimum time
	MAXimum	Maximum time
Setting example	:RES:T1 0.2 Sets the setting of the timer T1.	
Query syntax	:RESistance:T1?	
Return parameter	<NR2>	Return the setting of the timer T1, by the string.
Query example	: RES:T1? >0.2 The setting of the timer T1 is 0.2 seconds.	
Related commands	:RESistance:T2	

Set →
 → Query

4-12-12. :RESistance:T2

Description	Setting and query for the “Timer2” time of CR dynamic mode. This command applies in “Dyna.Time” is “T1/T2”.	
Setting syntax	:RESistance:T2 {<NRf> MINimum MAXimum}	
Setting parameter	<NRf>	T2 timer setting. (unit is seconds)
	MINimum	Minimum time
	MAXimum	Maximum time
Setting example	:RES:T2 0.2 Sets the setting of the timer T2.	
Query syntax	:RESistance:T2?	
Return parameter	<NR2>	Return the setting of the timer T2, by the string.
Query example	: RES:T2? >0.2 The setting of the timer T2 is 0.2 seconds.	
Related commands	:RESistance:T1	

Set →
 → Query

4-12-13. :RESistance:FREQUENCY

Description	Setting and query for “Frequency” value of the CR dynamic mode. This command applies in “Dyna.Time” is “Freq/Duty”.	
Setting syntax	:RESistance:FREQUENCY {<NRf> MINimum MAXimum}	
Setting parameter	<NRf>	Sets the switching frequency (unit is hertz).
	MINimum	Minimum frequency
	MAXimum	Maximum frequency
Setting example	:RES:FREQ 60 Sets frequency to 60Hz.	
Query syntax	:RESistance:FREQUENCY?	
Return parameter	<NR2>	Return the switching frequency, by the string.
Query example	:RES:FREQ? >60 Returns the switching frequency as 60Hz.	
Related commands	:RESistance:DUTY	

Set →
 → Query

4-12-14. :RESistance:DUTY

Description	Setting and query for “Duty” % of the CR dynamic mode. This command applies in “Dyna.Time” is “Freq/Duty”.	
Setting syntax	:RESistance:DUTY {<NRf> MINimum MAXimum}	
Setting parameter	<NRf>	Sets the duty as a percentage.
	MINimum	Minimum duty
	MAXimum	Maximum duty
Setting example	:RES:DUTY 50 Sets the duty cycle 50%.	
Query syntax	:RESistance:DUTY?	
Return parameter	<NR2>	Return the duty cycle of positive, by the string.
Query example	:RES:DUTY? >50 Returns the duty cycle as 50%.	
Related commands	:RESistance:FREQUENCY	

Set →
 → Query

4-12-15. :RESistance:RECall

Description	Sets or queries whether A Value or B Value is the currently active value in CR static mode when the units are set to ohm.
Setting syntax	:RESistance:RECall {<Boolean> A B}
Setting parameter	A 0 CR Value = A Value B 1 CR Value = B Value
Setting example	:RES:REC A Sets A value of CR resistance setting mode to active.
Query syntax	:RESistance:RECall?
Return parameter	Return the currently active value in CR static mode. 0 CR Value = A Value 1 CR Value = B Value
Query example	:RES:REC? >0 Return the CR active setting is A value.

Set →
 → Query

4-12-16. :CONDuctance[:VA]

Description	Setting and query for the "A Value" conductance of the CR static mode. Note: A different value can be set for each current range (High/Mid/Low). Note: The optional command node [:VA] can only be omitted when in static mode.
Setting syntax	:CONDuctance [:VA] {<NRf> MINimum MAXimum}
Setting parameter	<NRf> "A Value" conductance value. Unit is [mS]. MINimum Minimum conductance level MAXimum Maximum conductance level
Setting example	:COND:VA MIN Sets the conductance value to the minimum.
Query syntax	:RESistance[:VA]?
Return parameter	<NR2> Return the conductance value of "A Value", by the string.
Query example	:COND:VA? >9.840 Return the conductance value (9.84mS) of "A Value".

4-12-17. :CONDuctance[:VA]:TRIGgered

Set →

Description	Set the conductance value when the trigger is activated.
Setting syntax	:CONDuctance[:VA]:TRIGgered {<NRf> MINimum MAXimum }
Setting parameter	<NRf> "A Value" conductance value. Unit is mS.
	MINimum Minimum conductance level
	MAXimum Maximum conductance level
Setting example	:COND:TRIG MIN Set the minimum conductance value when the trigger is activated.
Related commands	*TRG, :INITiate:CONTinuous, :INITiate[:IMMEDIATE]

4-12-18. :CONDuctance:VB

Set →

→ Query

Description	Setting and query for the "B Value" conductance of the CR static mode. Note: A different value can be set for each current range (High/Mid/Low).
Setting syntax	:CONDuctance:VB {<NRf> MINimum MAXimum}
Setting parameter	<NRf> "B Value" conductance value. Unit is [mS].
	MINimum Minimum conductance level
	MAXimum Maximum conductance level
Setting example	:COND:VB MIN Sets the conductance value to the minimum.
Query syntax	:CONDuctance:VB?
Return parameter	<NR2> Return the conductance value of "B Value", by the string.
Query example	:COND:VB? >9.840 Return the conductance value (9.84mS) of "B Value".

4-12-19. :CONDuctance:L1

Description	<p>Setting and query for the "Level1" conductance of the CR dynamic mode.</p> <p>This command applies in "Dyna.Level" is "Value".</p> <p>Note: A different value can be set for each current range (High/Mid/Low).</p>						
Setting syntax	:CONDuctance:L1 {<NRf> MINimum MAXimum}						
Setting parameter	<table border="1"> <tr> <td><NRf></td> <td>"level1" conductance value. Unit is [mS].</td> </tr> <tr> <td>MINimum</td> <td>Minimum conductance level</td> </tr> <tr> <td>MAXimum</td> <td>Maximum conductance level</td> </tr> </table>	<NRf>	"level1" conductance value. Unit is [mS].	MINimum	Minimum conductance level	MAXimum	Maximum conductance level
<NRf>	"level1" conductance value. Unit is [mS].						
MINimum	Minimum conductance level						
MAXimum	Maximum conductance level						
Setting example	:COND:L1 MIN Sets the conductance value to the minimum.						
Query syntax	:CONDuctance:L1?						
Return parameter	<NR2> Return the conductance value of "Level1", by the string.						
Query example	:COND:L1? >9.840 Return the conductance value (9.84mS) of "Level1".						

4-12-20. :CONDuctance:L2

Description	<p>Setting and query for the "Level2" conductance of the CR dynamic mode.</p> <p>This command applies in "Dyna.Level" is "Value".</p> <p>Note: A different value can be set for each current range (High/Mid/Low).</p>						
Setting syntax	:CONDuctance:L2 {<NRf> MINimum MAXimum}						
Setting parameter	<table border="1"> <tr> <td><NRf></td> <td>"level2" conductance value. Unit is [mS].</td> </tr> <tr> <td>MINimum</td> <td>Minimum conductance level</td> </tr> <tr> <td>MAXimum</td> <td>Maximum conductance level</td> </tr> </table>	<NRf>	"level2" conductance value. Unit is [mS].	MINimum	Minimum conductance level	MAXimum	Maximum conductance level
<NRf>	"level2" conductance value. Unit is [mS].						
MINimum	Minimum conductance level						
MAXimum	Maximum conductance level						
Setting example	:COND:L2 MIN Sets the conductance value to the minimum.						
Query syntax	:CONDuctance:L2?						
Return parameter	<NR2> Return the Millisiemens value of "Level2", by the string.						
Query example	:COND:L2? >9.840 Return the conductance value (9.84mS) of "Level2".						

4-12-21. :CONDuctance:SET

Description	Setting and query for the "Set" conductance of the CR dynamic mode. This command applies in "Dyna.Level" is "Percent".	
Setting syntax	:CONDuctance:SET {<NRf> MINimum MAXimum}	
Setting parameter	<NRf>	"The conductance value at the time of "Level=100%". Unit is [mS].
	MINimum	Minimum conductance level
	MAXimum	Maximum conductance level
Setting example	:COND:SET MIN Sets the minimum conductance value of "Level = 100%".	
Query syntax	:CONDuctance:SET?	
Return parameter	<NR2>	Return the conductance value of "Level = 100%", by the string.
Query example	:COND:SET? >9.840 Return the conductance value (9.84mS) of "Level = 100%".	

4-12-22. :CONDuctance:RECall

Description	Sets or queries whether A Value or B Value is the currently active value in CR static mode when the units are set to Siemens.	
Setting syntax	:CONDuctance:RECall {<Boolean> A B}	
Setting parameter	A 0	CR Value = A Value
	B 1	CR Value = B Value
Setting example	:COND:REC A Sets A value of CR conductance setting mode to active.	
Query syntax	:CONDuctance:RECall?	
Return parameter	Return the currently active value in CR static mode.	
	0	CR Value = A Value
	1	CR Value = B Value
Query example	:RES:REC? >0 Return the CR active setting is A value.	

4-13. Voltage Subsystem Commands

Set →

4-13-1. :VOLTage[:VA]

→ Query

Description	Setting and query for the CV mode "A Value" voltage or the +CV voltage value. Note: The same value applies for each current range (High/Mid/Low). Note: The optional command node [:VA] can only be omitted when in static mode.
Setting syntax	:VOLTage[:VA] {<NRf> MINimum MAXimum}
Setting parameter	<NRf> "A Value" voltage value. Unit is [V].
	MINimum Minimum voltage level
	MAXimum Maximum voltage level
Setting example	:VOLT:VA MIN Sets the voltage value to the minimum.
Query syntax	:VOLTage[:VA]?
Return parameter	<NR2> Return the voltage value of "A Value", by the string.
Query example	:VOLT:VA? >1.00 Voltage setting of "A Value" is set to 1V.

Set →

4-13-2. :VOLTage:VB

→ Query

Description	Setting and query for the CV mode "B Value". Note: The same value applies for each current range (High/Mid/Low).
Setting syntax	:VOLTage:VB {<NRf> MINimum MAXimum}
Setting parameter	<NRf> "B Value" voltage value. Unit is [V].
	MINimum Minimum voltage level
	MAXimum Maximum voltage level
Setting example	:VOLT:VB MIN Sets the voltage value to the minimum.
Query syntax	:VOLTage:VB?
Return parameter	<NR2> Return the voltage value of "B Value", by the string.
Query example	:VOLT:VB? >1.00 Voltage setting of "B Value" is set to 1V.

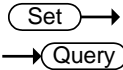

4-13-3. :VOLTage:RECall

Description	Sets or queries whether A Value or B Value is the currently active value in CV mode.
Setting syntax	:VOLTage:RECall {<Boolean> A B}
Setting parameter	A 0 CV active setting = A Value
	B 1 CV active setting = B Value
Setting example	:VOLT:REC A Sets A value of CV setting mode to active.
Query syntax	:VOLTage:RECall?
Return parameter	Return the currently active value in CR mode.
	0 CV active setting = A Value
	1 CV active setting = B Value
Query example	:VOLT:REC? >0 Return the CV active setting is A Value.

4-14. Power Subsystem Commands

Set →

4-14-1. :POWER[:VA]

→ Query

Description	Setting and query for the “A Value” power of the CP static mode. Note: A different current value can be set for each current range (High/Mid/Low). Note: The [:VA] node can only be omitted when in static mode.
Setting syntax	:POWER[:VA] {<NRf> MINimum MAXimum}
Setting parameter	<NRf> “A Value” power value. Unit is [W].
	MINimum Minimum power level
	MAXimum Maximum power level
Setting example	:POW:VA MIN Sets the power value to the minimum.
Query syntax	:POWER[:VA]?
Return parameter	<NR2> Return the power value of “A Value”, by the string.
Query example	:POW:VA? >10 Power setting of “A Value” is set to 10W.

Set →

4-14-2. :POWER:VB

→ Query

Description	Setting and query for the “B Value” power of the CP static mode. Note: A different current value can be set for each current range (High/Mid/Low).
Setting syntax	:POWER:VB {<NRf> MINimum MAXimum}
Setting parameter	<NRf> “B Value” power value. Unit is [W].
	MINimum Minimum power level
	MAXimum Maximum power level
Setting example	:POW:VB MIN Sets the power value to the minimum.
Query syntax	:POWER:VB?
Return parameter	<NR2> Return the power value of “B Value”, by the string.
Query example	:POW:VB? >10 Power setting of “B Value” is set to 10W.





4-14-3. :POWer:L1

Description	Setting and query for the "Level1" power of the CP dynamic mode. This command applies in "Dyna.Level" is "Value". Note: A different "Level1" value can be set for different current ranges.						
Setting syntax	:POWer:L1 {<NRf> MINimum MAXimum}						
Setting parameter	<table border="1"> <tr> <td><NRf></td> <td>"Level1" power value. Unit is [W].</td> </tr> <tr> <td>MINimum</td> <td>Minimum power level</td> </tr> <tr> <td>MAXimum</td> <td>Maximum power level</td> </tr> </table>	<NRf>	"Level1" power value. Unit is [W].	MINimum	Minimum power level	MAXimum	Maximum power level
<NRf>	"Level1" power value. Unit is [W].						
MINimum	Minimum power level						
MAXimum	Maximum power level						
Setting example	:POW:L1 MIN Sets the power value to the minimum.						
Query syntax	:POWer:L1?						
Return parameter	<NR2> Return the power value of "Level1", by the string.						
Query example	:POW:L1? >10 Power setting of "Level1" is set to 10W.						





4-14-4. :POWer:L2

Description	Setting and query for the "Level2" power of the CP dynamic mode. This command applies in "Dyna.Level" is "Value". Note: A different "Level2" value can be set to different current ranges.						
Setting syntax	:POWer:L2 {<NRf> MINimum MAXimum}						
Setting parameter	<table border="1"> <tr> <td><NRf></td> <td>"Level2" power value. Unit is [W].</td> </tr> <tr> <td>MINimum</td> <td>Minimum power level</td> </tr> <tr> <td>MAXimum</td> <td>Maximum power level</td> </tr> </table>	<NRf>	"Level2" power value. Unit is [W].	MINimum	Minimum power level	MAXimum	Maximum power level
<NRf>	"Level2" power value. Unit is [W].						
MINimum	Minimum power level						
MAXimum	Maximum power level						
Setting example	:POW:L2 MIN Sets the power value to the minimum.						
Query syntax	:POWer:L2?						
Return parameter	<NR2> Return the power value of "Level2", by the string.						
Query example	:POW:L2? >10 Power setting of "Level2" is set to 10W.						

Set →

→ Query

4-14-5. :POWER:SET

Description	Setting and query for the "Set" power of the CP dynamic mode. This command applies in "Dyna.Level" is "Percent".	
Setting syntax	:POWER:SET {<NRf> MINimum MAXimum}	
Setting parameter	<NRf>	The power value at the time of "Level=100%". Unit is [W].
	MINimum	Minimum power value
	MAXimum	Maximum power value
Setting example	:POW:SET MIN Sets the minimum power value of "Level = 100%".	
Query syntax	:POWER:SET?	
Return parameter	<NR2>	Return the power value of "Level = 100%", by the string.
Query example	:POW:SET? >10 power value of "Level = 100%" is set to 10W.	
Related commands	:POWER:LEVel	

Set →

→ Query

4-14-6. :POWER:LEVel

Description	Setting and query for the "Set" power of the CP dynamic mode. This command applies in "Dyna.Level" is "Percent".	
Setting syntax	:POWER:LEVel {<NRf> MINimum MAXimum}	
Setting parameter	<NRf>	% of "Set" power level (unit is %)
	MINimum	Minimum % power level
	MAXimum	Maximum % power level
Setting example	:POW:LEV MIN Sets the % level power value to the minimum.	
Query syntax	:POWER:LEVel?	
Return parameter	<NR2>	Return the power of "% Level", by the string.
Query example	:POW:LEV? >50 Percentage of the set power value is set to 50%.	
Related commands	:POWER:Set	

Set →
 → Query

4-14-7. :POWER:T1

Description	Setting and query for the “Timer1” time of CP dynamic mode. This command applies in “Dyna.Time” is “T1/T2”.						
Setting syntax	:POWER:T1 {<NRf> MINimum MAXimum}						
Setting parameter	<table border="1" style="width: 100%;"> <tr> <td style="background-color: #e0e0e0;"><NRf></td> <td>T1 timer setting. (unit is seconds)</td> </tr> <tr> <td style="background-color: #e0e0e0;">MINimum</td> <td>Minimum time</td> </tr> <tr> <td style="background-color: #e0e0e0;">MAXimum</td> <td>Maximum time</td> </tr> </table>	<NRf>	T1 timer setting. (unit is seconds)	MINimum	Minimum time	MAXimum	Maximum time
<NRf>	T1 timer setting. (unit is seconds)						
MINimum	Minimum time						
MAXimum	Maximum time						
Setting example	:POW:T1 0.2 Sets the setting of the timer T1.						
Query syntax	:POWER:T1?						
Return parameter	<NR2>						
Query example	:POW:T1? >0.2 Return the setting of the timer T1.						
Related commands	:POWER:T2						

Set →
 → Query

4-14-8. :POWER:T2

Description	Setting and query for the “Timer2” time of CP dynamic mode. This command applies in “Dyna.Time” is “T1/T2”.						
Setting syntax	:POWER:T2 {<NRf> MINimum MAXimum}						
Setting parameter	<table border="1" style="width: 100%;"> <tr> <td style="background-color: #e0e0e0;"><NRf></td> <td>T2 timer setting. (unit is seconds)</td> </tr> <tr> <td style="background-color: #e0e0e0;">MINimum</td> <td>Minimum time</td> </tr> <tr> <td style="background-color: #e0e0e0;">MAXimum</td> <td>Maximum time</td> </tr> </table>	<NRf>	T2 timer setting. (unit is seconds)	MINimum	Minimum time	MAXimum	Maximum time
<NRf>	T2 timer setting. (unit is seconds)						
MINimum	Minimum time						
MAXimum	Maximum time						
Setting example	:POW:T2 0.2 Sets the setting of the timer T2.						
Query syntax	:POWER:T2?						
Return parameter	<NR2>						
Query example	:POW:T2? >0.2 Returns the setting of the timer T2.						
Related commands	:POWER:T1						

Set →
 → Query

4-14-9. :POWER:FREQUENCY

Description	Setting and query for “Frequency” value of the CP dynamic mode. This command applies in “Dyna.Time” is “Freq/Duty”.						
Setting syntax	:POWER:FREQUENCY {<NRf> MINimum MAXimum}						
Setting parameter	<table border="1" style="width: 100%;"> <tr> <td style="background-color: #e0e0e0;"><NRf></td> <td>Sets the switching frequency (unit is hertz).</td> </tr> <tr> <td style="background-color: #e0e0e0;">MINimum</td> <td>Minimum frequency</td> </tr> <tr> <td style="background-color: #e0e0e0;">MAXimum</td> <td>Maximum frequency</td> </tr> </table>	<NRf>	Sets the switching frequency (unit is hertz).	MINimum	Minimum frequency	MAXimum	Maximum frequency
<NRf>	Sets the switching frequency (unit is hertz).						
MINimum	Minimum frequency						
MAXimum	Maximum frequency						
Setting example	:POW: FREQ 60 Sets the frequency to 60Hz.						
Query syntax	:POWER: FREQUENCY?						
Return parameter	<NR2>						
Query example	:POW: FREQ? >60 Returns the switching frequency as 60Hz.						
Related commands	:POWER: DUTY						

Set →
 → Query

4-14-10. :POWER:DUTY

Description	Setting and query for “Duty” % of the CP dynamic mode. This command applies in “Dyna.Time” is “Freq/Duty”.						
Setting syntax	:POWER:DUTY {<NRf> MINimum MAXimum}						
Setting parameter	<table border="1" style="width: 100%;"> <tr> <td style="background-color: #e0e0e0;"><NRf></td> <td>Sets the duty cycle as a percentage.</td> </tr> <tr> <td style="background-color: #e0e0e0;">MINimum</td> <td>Minimum duty</td> </tr> <tr> <td style="background-color: #e0e0e0;">MAXimum</td> <td>Maximum duty</td> </tr> </table>	<NRf>	Sets the duty cycle as a percentage.	MINimum	Minimum duty	MAXimum	Maximum duty
<NRf>	Sets the duty cycle as a percentage.						
MINimum	Minimum duty						
MAXimum	Maximum duty						
Setting example	:POW:DUTY 50 Sets the duty cycle 50%.						
Query syntax	:POWER:DUTY?						
Return parameter	<NR2>						
Query example	:POW:DUTY? >50 Returns the duty cycle as 50%.						
Related commands	:POWER:FREQUENCY						

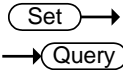

4-14-11. :POWer:RECall

Description	Sets or queries whether A Value or B Value is the currently active value in CP static mode.
Setting syntax	:POWer:RECall {<Boolean> A B}
Setting parameter	A 0 CP active setting = A Value
	B 1 CP active setting = B Value
Setting example	:POW:REC A Sets A value of CP setting mode to active.
Query syntax	:POWer:RECall?
Return parameter	Return the currently active value in CP mode.
	0 CP active setting = A Value
	1 CP active setting = B Value
Query example	:POW:REC? >0 Return the CP active setting.

4-15. Program Commands

To execute / stop the program function, use: INPUT command.
 Refer to the page 21 (4-3-1.: INPut).

Set →

4-15-1. :FUNCTION[:COMPLETE][:RING]:TIME

→ Query

Description	Setting and query for how long the alarm will buzz for after a Program, NSEQ, FSEQ, OCP, OPP or BATT test function has finished.	
Setting syntax	:FUNCTION[:COMPLETE][:RING]:TIME {<NR1> MINimum MAXimum INFINITY}	
Setting parameter	<NR1>	Alarm time in seconds (0~600); 0 = OFF
	MINimum	Minimum alarm time
	MAXimum	Maximum alarm time
	INFINITY	Sets the alarm time to infinity.
Setting example	:FUNC:TIME 5 Sets the function complete ring time to 5s.	
Query syntax	:FUNCTION[:COMPLETE][:RING]:TIME?	
Return parameter	<NR1> Infinity OFF	Return the function complete ring times, by the string. "OFF" is the ring time off.
Query example	:FUNC:TIME? >5 The function complete ring time is set as 5s.	

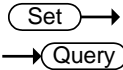

4-15-2. :PROG:STATe

Description	Setting and query for the state of the program function.	
Setting syntax	:PROG:STATe {ON OFF PAUSE CONTINUE NEXT}	
Setting parameter	ON	Turn Program function on
	OFF	Program function off
	PAUSE	Program function pause
	RUN	Program function running
	CONTINUE	Program function continue
	NEXT	Next step in the program function
Setting example	:PROG:STAT ON Turn program function on.	
Query syntax	:PROG:STATe?	
Return parameter	Return the state of the program function, by the string.	
	ON, STOP RUN PAUSE	Program function is on. "STOP": stopped, "RUN": running, "PAUSE": paused
	OFF	Program function is off
Query example	:PROG:STAT? >ON,STOP Return the state of the program function.	

Set →

→ Query

4-15-3. :PROGram

Description	Setting and query for all parameters to specified step of the program function. Parameters of "Timing Edit for Program".	
Setting syntax	:PROGram (1),(2),(3),(4),(5),(6),(7),(8)	
Setting parameter	(1) <NR1>	Program number (1~16)
	(2) <NR1>	Step number (1~16)
	(3) <NR1>	Internal memory number (1~256)
	(4) <ASCII string>	Processing settings AUTO: Run processing MANUAL : Wait for the start-up process SKIP : Proceed to the next step
	(5) <NRf>	On-time (0.1~60)s
	(6) <NRf>	Off-time (Off,0.1~60)s
	(7) <NRf>	Delay time of the P/F (Off,0.0~119.9)s
	(8) <NRf>	Short time (Off,0.1 ~ On-Time)s
Setting example	:PROG 2,3,1,AUTO,40.1,0,0,0 Set all the parameters to specified program step.	
Query syntax	:PROGram?	
Return parameter	In the following order, return the parameters of "Timing Edit for Program".	
	(1) <ASCII string>	Return the program function.{ON OFF}
	(2) <ASCII string>	Program number
	(3) <ASCII string>	Step number
	(4) <ASCII string>	Internal memory number
	(5) <ASCII string>	Processing is returned by Auto/Manual/Skip.
	(6) <ASCII string>	On-time (unit is seconds)
	(7) <ASCII string>	Off-time (unit is seconds)
	(8) <ASCII string>	Delay time of the P/F (unit is seconds)
	(9) <ASCII string>	Short time (unit is seconds)
Query example	:PROG? >Program:OFF; Start:1, Step:1, Memory:1, Run:Skip, On-Time:0.1, Off-Time:0.0, P/F-Time:0.0, Short-Time:0.0 Return the parameters of the program step that is selected after the state of the program function.	

4-15-4. :PROGram[:RECall]:DEFault

Set →

Description	All steps of a selected program are set by default value.
Setting syntax	:PROGram[:RECall]:DEFault
Setting example	:PROG:DEF All steps of a selected program are set by default value.

Set →

4-15-5. :PROGram:STARt

→ Query

Description	Setting and query for select program number. (Contents of PROG:)
Setting syntax	:PROGram:STARt <NR1>
Setting parameter	<NR1> Program number to select. (1~16)
Setting example	:ROG:STAR 1 Sets to 1 of program number.
Query syntax	:PROGram:STARt?
Return parameter	Start:<NR1> Return the Program number in selected, by the string.
Query example	:PROG:STAR? >Start:1 Return The selected program number.

Set →

4-15-6. :PROGram:STEP

→ Query

Description	Setting and query for the step number of the program to select. (Contents of STEP:)
Setting syntax	:PROGram:STEP <NR1>
Setting parameter	<NR1> Step number to select. (1~16)
Setting example	:PROG:STEP 1 Sets to 1 of step number.
Query syntax	: PROGram:STEP?
Return parameter	Step :< NR1> Return the step number of the program, by the string.
Query example	:PROG:STEP? >Step:1 Return the step number of the program.

Set →
→ Query

4-15-7. :PROG:MEMory

Description	Setting and query for memory number of selected program steps. (Contents of Memory:)	
Setting syntax	:PROG:MEMory <NR1>	
Setting parameter	<NR1>	Sets the memory number. (1~256)
Setting example	:PROG:MEM 1 Sets to 1 of memory number.	
Query syntax	:PROG:MEMory?	
Return parameter	Memory:M<NR1>	Return the memory number of selected, by the string.
Query example	:PROG:MEM? >Memory:M 1 Return the memory number of selected.	

Set →
→ Query

4-15-8. :PROG:RUN

Description	Setting and query for execution process of selected program steps. (Contents of Run:)	
Setting syntax	:PROG:RUN {AUTO MANual SKIP}	
Setting parameter	AUTO	Sets to auto-run processing.
	MANual	Sets to wait run.
	SKIP	Sets to the next processing steps.
Setting example	:PROG:RUN AUTO Sets to auto-run processing.	
Query syntax	:PROG:RUN?	
Return parameter	Run: Auto Manual Skip	Return the execution process, by the string.
Query example	:PROG:RUN? >Run:Auto Return the execution process.	

Set →

→ Query

4-15-9. :PROG:ONTime

Description	Setting and query for On time of selected program steps. (Contents of On-Time:)	
Setting syntax	:PROG:ONTime <NRf>	
Setting parameter	<NRf>	On time (0.1~60 seconds)
Setting example	:PROG:ONT 1 Sets to 1 second On time.	
Query syntax	:PROG:ONTime?	
Return parameter	On-Time:<NR2>	Return the On time of selected program steps, by the string.
Query example	:PROG:ONT? >On-Time:0.1 Return in seconds On time (0.1 second).	
Related commands	:PROG:PFTIME :PROG:STIME	

Set →

→ Query

4-15-10. :PROG:OFFTime

Description	Setting and query for Off time of selected program steps. (Contents of Off-Time:)	
Setting syntax	:PROG:OFFTime {<NRf> OFF}	
Setting parameter	<NRf>	Off time (Off,0.1~60 seconds) Setting of 0 is off Setting function.
	OFF	Setting off function
Setting example	:PROG:PFT 1 Sets to 1 second Off time.	
Query syntax	:PROG:OFFTime?	
Return parameter	Off-Time:<NR2>	Return the Off time of selected program steps, by the string. "Off-Time:0.0" is a function off.
Query example	:PROG:OFFT? >Off-Time:1.0 Return the Off time (1 second).	
Related commands	:PROG:PFTIME	

Set →

→ Query

4-15-11. :PROGRAM:PFTIME

Description	The pass / fail judgment (Go-NoGo Test) of the program selected step. Setting and query for the judgment delay time. (Contents of P/F-Time:)	
Setting syntax	:PROGRAM:PFTIME {<NRf> OFF}	
Setting parameter	<NRf>	Set in seconds the judgment delay time. (Off,0.0~119.9)s 0 setting is off a judgment function.
	OFF	Sets off Judgment function
Setting example	:PROG:PFT 1 Delay time of the judgment sets 1 second.	
Query syntax	:PROGRAM:PFTIME?	
Return parameter	P/F-Time:<NR2>	Return the judgment delay time, by the string. "P/F-Time:0.0" is a function off.
Query example	:PROG:PFT >P/F-Time:1.0 Return the judgment delay time.	
Related commands	:PROGRAM:OFFTIME :PROGRAM:ONTIME	

Set →

→ Query

4-15-12. :PROGRAM:STIME

Description	Setting and query for load short time of selected program step. (Contents of Short-Time:)	
Setting syntax	:PROGRAM:STIME <NR1>	
Setting parameter	<NRf>	Sets in time seconds of load short time. (Off,0.1 ~ On-Time)s 0 setting is the off feature of load short.
	OFF	Sets the off feature of load short.
Setting example	:PROG:STIM 1 Sets to 1 second of load short.	
Query syntax	:PROGRAM:STIME?	
Return parameter	Short-Time:<NR2>	Return the setting time of load short, by the string.
Query example	:PROG:STIM? >Short-Time:0.0 Return the setting time of load short.	
Related commands	:PROGRAM:ONTIME	

Set →

→ Query

4-15-13. [:PROGrama]:CHAI:n:STARt

Description	Setting and query for the start program number of the program chain. (Contents of Start) Parameters of "Program Chain Set"
Setting syntax	[:PROGrama]:CHAI:n:STARt <NR1>
Setting parameter	<NR1> Start program number.
Setting example	:CHA:STAR 1 Sets to number 1 start program.
Query syntax	[:PROGrama]:CHAI:n:STAR?
Return parameter	P<NR1> Return the start program number, by the string.
Query example	:CHA:STAR? >P1 Return the start program number.

Set →

→ Query

4-15-14. [:PROGrama]:CHAI:n

Description	Setting and query for all chain of the program chain. (Contents of PXX)
Setting syntax	[:PROGrama]:CHAI:n (1),(2),(3),(4),..., (14),(15),(16)
Setting parameter	(N) {<NR1> OFF} The program number to chain. (Note: If the part with N = 3 is 2, it becomes P03→P02) N:1,2,...,15,16 "OFF" sets off the chain.
Setting example	:CHA 4,OFF,OFF,5,6,OFF,OFF,OFF,OFF,OFF,OFF, OFF,OFF,OFF,OFF,OFF Configures the program chain as follows: P01→P04→P05→P06→OFF
Query syntax	[:PROGrama]:CHAI:n?
Return parameter	Return the setting value of all program chain. P1->PXX; P2-> PXX; ... "Off" is the end of the chain. P15->PXX; P16-> PXX
Query example	:CHA? >P1->P4;P2->Off;P3->Off;P4->P5;P5->P6;P6->Off;P7->O ff;P8->Off;P9->Off;P10->Off;P11->Off;P12->Off;P13->Of f;P14->Off;P15->Off;P16->Off Return the setting value of all program chain.

Set →

→ Query

4-15-15. [:PROGram]:CHAI:n:P2P

Description	Setting and query for a single link in the program chain.	
Setting syntax	[:PROGram]:CHAI:n:P2P <NR1>,{<NR1> OFF}	
Setting parameter	<NR1>	(1~16) Program number of single link.
	<NR1> OFF	(1~16) Program number that follows. "OFF" is set the chain off.
Setting example	:CHA:P2P 4,3 Program 4 will chain set in the program 3.P4→P3	
Query syntax	[:PROGram]:CHAI:n:P2P? PX	
Query parameter	PX	P1~P16 The program number of the first link of the chain that you are inquiring about.
Return parameter	PX→PX OFF	Returns the program number that follows or OFF.
Query example	:CHA:P2P? P4 >P4->3 Indicates that program 3 follows from program 4 in the chain.P4→P3	

4-15-16. [:PROGram]:CHAI:n[:RECall]:DEFault

Set →

Description	Turn off all the program chains.	
Setting syntax	[:PROGram]:CHAI:n[:RECall]:DEFault	
Setting example	:CHA:DEF Turn off all the program chain.	

4-15-17. :PROGram:SAVE

Set →

Description	Save program.	
Setting syntax	:PROG:SAVE	
Setting example	:PROG:SAVE Save program.	

4-16. Normal sequence Commands

To execute / stop the sequence, use: INPUT command.
 Refer to the page 21 (4-3-1.: INPUT).

Set →

→ Query

4-16-1. :NSEquence:STATE

Description	Setting and query for the state of the Normal Sequence function.	
Setting syntax	:NSEquence:STATE {OFF ON PAUSE CONTINUE EXT}	
Setting parameter	OFF	Normal sequence function Off
	ON	Normal sequence function On
	PAUSE	Pause sequence function
	CONTINUE	Continue sequence function
	NEXT	Go to next sequence function
Setting example	:PROG:STAT ON Turn on the normal sequence function.	
Query syntax	:NSEquence:STATE?	
Return parameter	Return the state of the normal sequence function.	
	ON, STOP RUN PAUSE	Normal sequence function on "STOP": stopped, "RUN": running, "PAUSE": Suspended
	OFF	Normal sequence function off
Query example	:PROG:STAT? >ON,STOP Return the state of the normal sequence function.	

Set →

→ Query

4-16-2. :NSEquence

Description	Setting and query for parameters of the Normal Sequence function. Parameters of "Timing Edit for Normal Sequence". Note: Cannot change the range and mode of the load when there is a step data.	
Setting syntax	:NSEquence (1),(2),(3),(4),(5),(6),(7),(8),(9)	
Setting parameter	(1) <NR1>	Sets the start sequence number.(1~10)
	(2) <NR1>	Sets the sequence number. (1~10)
	(3) <ASCII string>	Sets the note of up to 12 characters. Enclose the string in double coat.
	(4) <ASCII string>	Sets the load mode. {CC CR CV CP}
	(5) <ASCII string>	Sets the load range. {IHVH IMVH ILVH IHVL IMVL ILVL}
	(6) <ASCII string>	Sets the loop count of the sequence. <NR1> 0 is infinite times. 1~9999. INFinity
	(7) <ASCII string>	Sets the Last Load after the end. {ON OFF}
	(8) <NRf>	Sets the Last Value after the end. (The Last Load ON is enabled by ON.)
	(9) <ASCII string>	Sets the chain of the next sequence. <NR1> : Sequence number OFF : No chain
Setting example	:NSEQ 1,1,"ABC",CC,ILVL,5,ON,1.5000,OFF Sets the parameters of "Timing Edit for Normal Sequence".	

Query syntax	:NSEquence?
Return parameter	In the following order, return the parameters of "Normal sequence timing edit".
	(1) <ASCII string> Return whether it is in normal sequence function state. {ON OFF}
	(2) <ASCII string> Return the start sequence number setting.
	(3) <ASCII string> Return the sequence number setting.
	(4) <ASCII string> Return the contents of the memo.
	(5) <ASCII string> Return the load mode setting. {CC CR CV CP}
	(6) <ASCII string> Return the load range setting.{IHVH IMVH ILVH IHVL IMVL ILVL}
	(7) <ASCII string> Return the loop count of the sequence. (Infinite times is the string "Infinity".)
	(8) <ASCII string> Return the Last Load after the end. {ON OFF}
	(9) <ASCII string> Return the Last Value after the end.
	(10)<ASCII string> Return the chain setting of the next sequence. (No-chain is a string "OFF".)
Query example	:NSEQ? >NSeq:ON; Start:1, Seq No:1, Memo:ABC, Mode:CC, Range:ILVL, Loop:5, Last Load:ON, Last:1.5000, Chain:Off Return the parameters of "Timing Edit for Normal Sequence".

Set →
 → Query

4-16-3. :NSEquence:STARt

Description	Setting and query for the start sequence number of the normal sequence. (Contents of Start:)
Setting syntax	:NSEquence:STARt <NR1>
Setting parameter	<NR1> Sets the start sequence number. (1~10)
Setting example	:NSEQ:STAR 1 Sets the start sequence number of the normal sequence.
Query syntax	:NSEquence:STARt?
Return parameter	Start:<NR1> Return the start sequence number of the normal sequence, by the string.
Query example	:NSEQ:STAR? >Start:1 Return the start sequence number of normal sequence.

Set →
 → Query

4-16-4. :NSEquence:NUMBER

Description	Setting and query for the sequence number of the normal sequence. (Contents of Seq.No:)
Setting syntax	:NSEquence:NUMBER <NR1>
Setting parameter	<NR1> Sets the sequence number. (1~10)
Setting example	:NSEQ:NUMB 1 Sets to 1 of normal sequence number.
Query syntax	:NSEquence:NUMBER?
Return parameter	Seq No:<NR1> Return the sequence number of the normal sequence by the string.
Query example	:NSEQ:NUMB? >Seq No:1 Return a sequence number that is selected.

Set →
 → Query

4-16-5. :NSEquence:MEMO

Description	Setting and query for the memo string of normal sequence. (Contents of Memo:)	
Setting syntax	:NSEquence:MEMO <ASCII string>	
Setting parameter	<ASCII string>	Set the characters up to 12 characters. Enclose the string in double coat.
Setting example	:NSEQ:MEMO "ABCD" Sets the memo of step.	
Query syntax	:NSEquence:MEMO?	
Return parameter	Memo:<ASCII string>	Return the memo of normal sequence that is selected, by the string.
Query example	:NSEQ:MEMO? >Memo:ABCD Return the memo of step.	

Set →
 → Query

4-16-6. :NSEquence:MODE

Description	Setting and query for the operating mode of the selected normal sequence. (Contents of Mode:)	
Setting syntax	:NSEquence:MODE {CC CR CV CP}	
Setting parameter	CC	Sets to constant current mode.
	CR	Sets to constant resistance mode.
	CV	Sets to constant voltage mode.
	CP	Sets to constant power mode.
Setting example	:NSEQ:MODE CC Sets the operating mode of the normal sequence.	
Query syntax	:NSEquence:MODE?	
Return parameter	Mode: CC CR CV CP	Return the operating mode of the normal sequence, by the string.
Query example	:NSEQ:MODE? >Mode:CC Return the operating mode of the normal sequence.	

4-16-7. :NSEquence:RANGe

Description	Setting and query for the operating range of the selected normal sequence. (Contents of Range:)	
Setting syntax	:NSEquence:RANGe {IHVH IMVH ILVH IHVL IMVL ILVL}	
Setting parameter	IHVH	Sets High current range and High voltage range.
	IMVH	Sets Middle current range and High voltage range.
	ILVH	Sets Low current range and High voltage range.
	IHVL	Sets High current range and Low voltage range.
	IMVL	Sets Middle current range and Low voltage range.
	ILVL	Sets Low current range Low voltage range.
Setting example	:NSEQ:RANG IHVL Sets operating of High current range and Low voltage range.	
Query syntax	:NSEquence:RANGe?	
Return parameter	Range: IHVH IMVH ILVH IHVL IMVL ILVL	Return the operating range of the normal sequence, by the string.
Query example	:NSEQ:RANG? > Range:IHVL Return the operating range of settings.	

4-16-8. :NSEquence:LOOP

Description	Setting and query for number of loops of normal sequence. (Contents of Loop:)	
Setting syntax	:NSEquence:LOOP {<NR1> INFinity}	
Setting parameter	<NR1>	Loop count setting. (1~9999)
	INFinity	Infinite number of times.
Setting example	:NSEQ:LOOP 1 Sets 1 to loop count of normal sequence.	
Query syntax	:NSEquence:LOOP?	
Return parameter	Loop: <NR1> InFinity	Return the number of loops of normal sequence, by the string.
Query example	:NSEQ:LOOP? >Loop:Infinity Return the loop number of normal sequence.	

Set →
 → Query

4-16-9. :NSEquence:LLOAD

Description	Setting and query for the Last Load state after the end of the normal sequence. (Contents of Last Load:)				
Setting syntax	:NSEquence:LLOAD {ON OFF}				
Setting parameter	<table border="1" style="width: 100%;"> <tr> <td style="width: 100px;">ON</td> <td>Turns Last Load on.</td> </tr> <tr> <td>OFF</td> <td>Turns Last Load off.</td> </tr> </table>	ON	Turns Last Load on.	OFF	Turns Last Load off.
ON	Turns Last Load on.				
OFF	Turns Last Load off.				
Setting example	:NSEQ:LLOAD ON Turns Last Load on.				
Query syntax	:NSEquence:LLOAD?				
Return parameter	<table border="1" style="width: 100%;"> <tr> <td style="width: 100px;">Last Load:</td> <td>Return the Last Load state of the load after the end of the step, by the string.</td> </tr> <tr> <td>ON OFF</td> <td></td> </tr> </table>	Last Load:	Return the Last Load state of the load after the end of the step, by the string.	ON OFF	
Last Load:	Return the Last Load state of the load after the end of the step, by the string.				
ON OFF					
Query example	:NSEQ:LLOAD? >Last Load:OFF Return the Last Load state after the end of the step.				
Related commands	:NSEquence:LAST				

Set →
 → Query

4-16-10. :NSEquence:LAST

Description	Setting and query for load value after the end of the normal sequence. (Contents of Last:)		
Setting syntax	:NSEquence:LAST <NR2>		
Setting parameter	<NR2> Sets load value after the end of step.		
Setting example	:NSEQ:LAST 1 Sets load value of after the step the end.		
Query syntax	:NSEquence:LAST?		
Return parameter	<table border="1" style="width: 100%;"> <tr> <td style="width: 100px;">Last:<NR2></td> <td>Return load value of after the step the end, by the string.</td> </tr> </table>	Last:<NR2>	Return load value of after the step the end, by the string.
Last:<NR2>	Return load value of after the step the end, by the string.		
Query example	:NSEQ:LAST? >Last:1.00 Return load value of after the step the end.		
Related commands	:NSEquence:LLOAD		

Set →

→ Query

4-16-11. :NSEquence:CHAIIn

Description	Query and settings for the next sequence in the chain. (Contents of Chain:)	
Setting syntax	:NSEquence:CHAIIn {<NR1> OFF}	
Setting parameter	<NR1>	The sequence number of the next sequence in the chain.
	OFF	chain is end.
Setting example	:NSEQ:CHA 1 Sets the next sequence in the chain as S01.	
Query syntax	:NSEquence:CHAIIn?	
Return parameter	Chain: <NR1> Off	Return the chain of Normal sequence number, by the string. "Off" is the end of the chain.
Query example	:NSEQ:CHA? >Chain:1 Returns the next sequence in the chain (S01).	

4-16-12. :NSEquence:EDIT

Description	Setting and query for the data edit of normal sequence. Parameters of "Data Edit for Normal Sequence"	
Setting syntax	:NSEquence:EDIT (1),(2),(3),(4),(5),(6),(7),(8),(9),(10),(11)	
Setting parameter	(1) <NR1>	The edit step number.
	(2) <NR1>	The total number of steps.
	(3) <NRf>	Sets a load value of operation mode.
	(4) <NR1>	Sets hours.
	(5) <NR1>	Sets minute.
	(6) <NR1>	Sets seconds.
	(7) <NR1>	Sets milliseconds.
	(8) <ASCII string>	Load setting. {ON OFF}
	(9) <ASCII string>	Lamp operation setting. {ON OFF}
	(10)<ASCII string>	Trigger Output setting. {ON OFF}
	(11)<ASCII string>	PAUSE Setting. {ON OFF}
Setting example	:NSEQ:EDIT 1,2,1,1,2,3,4,OFF,OFF,OFF,OFF Sets the data of normal step sequence program.	
Query syntax	:NSEquence:EDIT?	
Return parameter	In the following order, return the parameters of "Data Edit for Normal Sequence".	
	(1) <ASCII string>	Return the edit step number/total step number.
	(2) <ASCII string>	Return the setting value of the load of the operating mode.
	(3) <ASCII string>	Return the set time.
	(4) <ASCII string>	Return the setting of the load state.
	(5) <ASCII string>	Return the setting of the lamp operation.
	(6) <ASCII string>	Return the setting of TRIG OUT.
	(7) <ASCII string>	Return the setting of pause.
Query example	:NSEQ:EDIT? > Step:1/2, Value:1.000, Time:1H:2M:3S:4mS, LOAD:OFF, TRIG OUT:OFF, RAMP:OFF, PAUSE:OFF Return the selected step data of normal sequence program.	

Set →
 → Query

4-16-13. :NSEquence:EDIT:POINT

Description	Setting and query for the edit step number of the normal sequence.
Setting syntax	:NSEquence:EDIT:POINT {<NR1>}
Setting parameter	<NR1> The edit step number of the normal sequence. 1~1000
Setting example	:NSEquence:EDIT:POINT 10 Sets the edit step number 10.
Query syntax	:NSEquence:EDIT:POINT?
Return parameter	<NR1> Return the edit step number of the normal sequence.
Query example	:NSEquence:EDIT:POINT? >10 Returns the edit step number.
Related commands	:NSEquence:EDIT:END?

4-16-14. :NSEquence:EDIT:END

→ Query

Description	Returns the end of edit step number in the normal sequence.
Query syntax	:NSEquence:EDIT:END?
Return parameter	<NR1> 1~1000
Query example	:NSEquence:EDIT:END? > 20 Returns the end of edit step number.

4-16-15. :NSEquence[:DELet]:ALL

Set →

Description	Delete all the steps of the selected normal sequence.
Setting syntax	:NSEquence[:DELet]:ALL
Setting example	:NSEQ:ALL Delete all the steps of the selected normal sequence.

4-16-16. :NSEquence:SAVE

Set →

Description	Save program of normal sequence.
Setting syntax	:NSEquence:SAVE
Setting example	:NSEQ:SAVE Save program of normal sequence.

Set →

4-16-17. :NSEquence:COTime

→ Query

Description	Setting and query for the display timer of the normal sequence.
Setting syntax	:NSEquence:COTime {UP DOWN}
Setting parameter	UP Elapsed time (countup) DOWN Remaining (countdown)
Setting example	:NSEQ:COT? >UP Returns the display timer as UP (elapsed time).
Query syntax	:NSEquence:COTime?
Return parameter	:NSEQ:COT UP DOWN Return the display timer of the normal sequence, by the string.
Query example	:NSEQ:COT UP Sets the display timer to UP (elapsed time).

4-17. Fast sequence Commands

To execute / stop the sequence, use: INPUT command.
Refer to the page 21 (4-3-1.: INPUT).

Set →

→ Query

4-17-1. :FSEquence:STATe

Description	Setting and query for the state of the fast sequence function.	
Setting syntax	:FSEquence:STATe {OFF ON}	
Setting parameter	OFF	Turn fast sequence function off
	ON	Turn fast sequence function on
Setting example	:FSEQ:STAT ON Turn on the fast sequence.	
Query syntax	:FSEquence:STATe?	
Return parameter	Return the state of the fast sequence function by the string.	
	ON, STOP RUN	Fast sequence is on "STOP": stopped, "RUN": running
	OFF	Fast sequence is off
Query example	:FSEQ:STAT? >ON,STOP The fast sequence function is on, and stopped.	

Set →

→ Query

4-17-2. :FSEquence

Description	Setting and query for parameters of fast sequence. parameters of "Timing Edit Fast Sequence"	
Setting syntax	:FSEquence (1),(2),(3),(4),(5),(6),(7)	
Setting parameter	(1) <ASCII string>	Sets the note of up to 12 characters. Enclose the string in double coat.
	(2) <ASCII string>	Sets the load mode. {CC CR}
	(3) <ASCII string>	Sets the load range. {IHVH IMVH ILVH IHVL IMVL ILVL}
	(4) <ASCII string>	Return the loop count of the sequence. (An infinite time is the string "Infinity".)
	(5) <NRf>	Sets the time base. (unit is seconds)
	(6) <ASCII string>	Sets the Last Load after the end. {ON OFF}
	(7) <NRf>	Sets the Last Value after the end. (It is enabled by the Last Load ON.)
	(8) <NR1>	Sets the step number setting of the loop last.
Setting example	:FSEQ "ABC",CC,IHVL,1,0.025,OFF,1,0,1 Sets the parameters of "Timing Edit Fast Sequence".	

Query syntax	:FSEquence?
Return parameter	In the following order, return the parameters of "Timing Edit Fast Sequence"
	(1) <ASCII string> Return whether it is in fast sequence function state. {ON OFF}
	(2) <ASCII string> Return the contents of the memo.
	(3) <ASCII string> Return the load mode setting. {CC CR}
	(4) <ASCII string> Return the load range setting. {IHVH IMVH ILVH IHVL IMVL ILVL}
	(5) <ASCII string> Return the loop count of the sequence. (An infinite time is the string "Infinity".)
	(6) <ASCII string> Return the time base. (unit is m seconds)
	(7) <ASCII string> Return the Last Load after the end. {ON OFF}
	(8) <ASCII string> Return the Last Value after the end.
	(9) <ASCII string> Return the step number of the last loop.
Query example	:FSEQ? > FSeq:OFF; Memo:ABC, Mode:CC, Range:IHVL, Loop:1, Time Base:25.000, Last Load:OFF, Last:1.00, RPTSTEP:1 Return the parameters of "Timing Edit Fast Sequence".

Set →

→ Query

4-17-3. :FSEquence:MEMO

Description	Setting and query for the memo of fast sequence. (Contents of Memo:)	
Setting syntax	:FSEquence:MEMO <ASCII string>	
Setting parameter	<ASCII string>	Set the characters up to 12 characters. Enclose the string in double coat.
Setting example	:FSEQ:MEMO "ABC" Sets the memo of fast sequence.	
Query syntax	:FSEquence:MEMO?	
Return parameter	Memo:<ASCII string>	Return the memo of fast sequence, by the string.
Query example	:FSEQ:MEMO? >Memo: ABCD Return the memo of fast sequence.	

Set →

→ Query

4-17-4. :FSEquence:MODE

Description	Setting and query for the operating mode of fast sequence. (Contents of Mode:)	
Setting syntax	:FSEquence:MODE {CC CR}	
Setting parameter	CC	Sets to constant current mode.
	CR	Sets to constant resistance mode.
Setting example	:FSEQ:MODE CC Sets the operating mode of the fast sequence.	
Query syntax	:FSEquence:MODE?	
Return parameter	Mode:CC CR	Return the operating mode of fast sequence, by the string.
Query example	:FSEQ:MODE? >Mode:CC Return the operating mode of the fast sequence.	

4-17-5. :FSEquence:RANGE

Description	Setting and query for the operating range of the fast sequence. (Contents of Range:)	
Setting syntax	:FSEquence:RANGE {IHVH IMVH ILVH IHVL IMVL ILVL}	
Setting parameter	IHVH	Sets High current range and High voltage range.
	IMVH	Sets Middle current range and High voltage range.
	ILVH	Sets Low current range and High voltage range.
	IHVL	Sets High current range and Low voltage range.
	IMVL	Sets Middle current range and Low voltage range.
	ILVL	Sets Low current range Low voltage range.
Setting example	:FSEQ:RANG IHVL Sets operating of High current range and Low voltage range.	
Query syntax	:FSEquence:RANGE?	
Return parameter	Range: IHVH IMVH ILVH IHVL IMVL ILVL	Return the operating range of the fast sequence, by the string.
Query example	:FSEQ:RANG? >Range:IHVH Return the operating range of settings.	

4-17-6. :FSEquence:LOOP

Description	Setting and query for number of loops of fast sequence. (Contents of Loop:)	
Setting syntax	:FSEquence:LOOP {<NR1> INFINITY}	
Setting parameter	<NR1>	Loop count setting. (1~9999)
	INFINITY	Infinite number of times.
Setting example	:FSEQ:LOOP 1 Sets 1 to loop count of fast sequence.	
Query syntax	:FSEquence:LOOP?	
Return parameter	Loop: <NR1> Infinity	Return the number of loops of fast sequence, by the string.
Query example	:FSEQ:LOOP? >Loop:Infinity Return the loop number of fast sequence.	

Set →
 → Query

4-17-7. :FSEquence:TBASe

Description	Setting and query for the time-based of fast sequence. (Contents of Time Base:)	
Setting syntax	:FSEquence:TBASe <NRf>	
Setting parameter	<NRf>	Sets the time-base. (Unit is second.)
Setting example	:FSEQ:TBAS 0.6 Sets the 0.6 seconds to the time-base of fast sequence.	
Query syntax	:FSEquence:TBASe?	
Return parameter	Time Base:<NR2>	Return the time-based of fast sequence, by the string.
Query example	:FSEQ:TBAS? >Time Base:0.60000 Return the time-base.	

Set →
 → Query

4-17-8. :FSEquence:LLOAD

Description	Setting and query for the Last Load state of Fast sequence. (Contents of Last Load:)	
Setting syntax	:FSEquence:LLOAD {ON OFF}	
Setting parameter	ON	Turns Last Load on.
	OFF	Turns Last Load off.
Setting example	:FSEQ:LLOAD ON Turns Last Load on.	
Query syntax	:FSEquence:LLOAD?	
Return parameter	Last Load: ON OFF	Return the Last Load state, by the string.
Query example	:FSEQ:LLOAD? >Last Load:OFF Return the Last Load state of Fast sequence.	
Related commands	:FSEquence:LAST	

Set →

→ Query

4-17-9. :FSEquence:LAST

Description	Setting and query for the Load Value after the end of Fast sequence. (Contents of Last:)
Setting syntax	:FSEquence:LAST <NRf>
Setting parameter	<NRf> Sets the load setting value of after the end of step. (It is enabled by load conditions ON.)
Setting example	:FSEQ:LAST1 Sets the load setting value of after the end of step.
Query syntax	:FSEquence:LAST?
Return parameter	Last:<NR2> Return the load setting value of after the end of step, by the string.
Query example	:FSEQ:LAST? >Last:0.070000 Return the load setting value of after the end of step.
Related commands	:FSEquence:LLOAD

Set →

→ Query

4-17-10. :FSEquence:RPTStep

Description	Setting and query for the last step number per loop of the fast sequence. (Contents of RPTSTEP:)
Setting syntax	:FSEquence:RPTStep <NR1>
Setting parameter	<NR1> Sets the step number of the last loop.
Setting example	:FSEQ:RPTS 1 Sets the last step number per loop.
Query syntax	:FSEquence:RPTStep?
Return parameter	RPTSTEP:<NR1> Return the step number of the loop end of the fast sequence, by the string.
Query example	:FSEQ:RPTS? >RPTSTEP:1 Return the last step number per loop.

Set →
 → Query

4-17-11. :FSEquence:EDIT

Description	Setting and query for data of fast sequence. Parameters of “Data Edit for Fast Sequence”.	
Setting syntax	:FSEquence:EDIT (1),(2),(3),(4)	
Setting parameter	(1) <NR1>	Editing step.
	(2) <NR1>	Step total number.
	(3) <NRf>	Sets the load value of the operation mode.
	(4) <ASCII string>	Sets the TRIG OUT. {ON OFF}
Setting example	:FSEQ:EDIT 2,6,1,ON Sets the data of the fast sequence.	
Query syntax	:FSEquence:EDIT?	
Return parameter	In the following order, return the parameters of “Data Edit for Fast Sequence”.	
	(1) <ASCII string>	Return the total of an edit step and a step.
	(2) <ASCII string>	Return the load setting value of the operation mode.
	(3) <ASCII string>	Return the TRIG OUT. {ON OFF}
Query example	:FSEQ:EDIT? > Step:0001/0003; Value:0.00, TRIG OUT:OFF Return the data of the fast sequence.	

Set →
 → Query

4-17-12. :FSEquence:EDIT:POINT

Description	Setting and query for the edit step number of the fast sequence.	
Setting syntax	:FSEquence:EDIT:POINT <NR1>	
Setting parameter	<NR1>	1~1000
	The edit step number of the fast sequence.	
Setting example	:FSEquence:EDIT:POINT 10 Sets the edit step number 10.	
Query syntax	:FSEquence:EDIT:POINT?	
Return parameter	<NR1>	Return the edit step number of the fast sequence.
Query example	:FSEquence:EDIT:POINT? >10 Returns the edit step number.	
Related commands	:FSEquence:EDIT:END?	

4-17-13. :FSEquence:EDIT:END

→ Query

Description	Returns the end of edit step number in the fast sequence.
Query syntax	:FSEquence:EDIT:END?
Return parameter	<NR1> 1~1000
Query example	:FSEquence:EDIT:END? > 20
	Returns the end of edit step number.

4-17-14. :FSEquence[:DELet]:ALL

Set →

Description	Delete all programs of the fast sequence.
Setting syntax	:FSEquence[:DELet]:ALL
Setting example	:FSEQ:ALL Delete all programs of the fast sequence.

4-17-15. :FSEquence[:EDIT]:FILL

Set →
→ Query

Description	Query and setting for FILL of fast sequence. Parameters of "Fill Edit for Fast Sequence"	
Setting syntax	:FSEquence[:EDIT]:FILL (1),(2),(3),(4)	
Setting parameter	(1) <NRf>	Sets the start load value of the operating mode.
	(2) <NRf>	Sets the end load value of the operating mode.
	(3) <NR1>	Sets the step number of start.
	(4) <NR1>	Sets the step number of end.
Setting example	:FSEQ:FILL 0,5,1,6 Sets the terms of the FILL to Fast sequence program.	
Query syntax	:FSEquence[:EDIT]:FILL?	
Return parameter	In the following order, return the parameters of "Fill Edit for Fast Sequence".	
	(1)<ASCII string>	Return the start load value of the operating mode.
	(2)<ASCII string>	Return the end load value of the operating mode.
	(3)<ASCII string>	Return the step number of start.
	(4)<ASCII string>	Return the step number of end.
Query example	:FSEQ:FILL? >Start Value:0.00, End Value:5.00, Start Step:1, End Step:6 Return the setting value of FILL of fast sequence.	

4-17-16. :FSEquence:SAVE

Set →

Description	Save program of fast sequence.
Setting syntax	:FSEquence:SAVE
Setting example	:FSEQ:SAVE

Save program of fast sequence.

4-18. OCP Test Commands

To execute / stop the test, use: INPUT command.
 Refer to the page 21 (4-3-1.: INPUT).

Set →

→ Query

4-18-1. :OCP:STATE

Description	Setting and query for the state of the OCP function.	
Setting syntax	:OCP:STATE {<Boolean> OFF ON}	
Setting parameter	OFF 0	Turns the OCP function off.
	ON 1	Turns the OCP function on.
Setting example	:OCP:STATE ON	
	Turns the OCP function on.	
Query syntax	:OCP:STATE?	
Return Parameter	Return the OCP function state.	
	ON, STOP RUN END	OCP function is on. “STOP” is OCP test stop, “RUN” is OCP test running, “END” is OCP test finished.
	OFF	OCP function is off.
Query example	:OCP:STATE?	
	OFF	Indicates that the OCP function is turned off.

Set →

→ Query

4-18-2. :OCP:EDIT[:CHANnel]

Description	Setting and query for the settings of the selected OCP memory number. Parameters of "OCP Function"	
Setting syntax	:OCP:EDIT[:CHANnel](1),(2),(3),(4),(5),(6),(7),(8),(9)	
Setting parameter	(1) <NR1>	Memory Number (OCP.No:1~12)
	(2) <ASCII string>	Current range (Range:) LOW MIDDLE HIGH
	(3) <NR2>	Start current value (Start C: unit A)
	(4) <NR2>	End current value (End C: unit A)
	(5) <NR2>	Current step value (Step C: unit A)
	(6) <NR2>	Time step value (Step T:unit s)
	(7) <NR2>	Delay time value (Delay:unit s)
	(8) <NR2>	Trigger voltage (Trig V:unit V)
	(9) <NR2>	Steady state current after test has finished (last C:unit A)
Setting example	:OCP:EDIT 1, LOW, 0.5, 5.0, 0.1, 0.25, 0, 5.0, 1.0	
Query syntax	:OCP:EDIT[:CHANnel]?	
Return Parameter	In the following order, return all the settings for the selected OCP memory number.	
	(1) Temp:Seq_<NR1>	OCP.No:1~12.
	(2) Range: High Middle Low	Current range.
	(3) Start C:<NR2>	Start current value.
	(4) End C:<NR2>	End current value.
	(5) Step C:<NR2>	Current step value.
	(6) Step T:<NR2>	Time step value.
	(7) Delay: <NR2>	Delay time value.
	(8) TrigV :<NR2>	Trigger voltage.
	(9) Last C:<NR2>	Steady state current after test has finished.
Query example	:OCP:EDIT? Temp:Seq_1, Range: High, Start C:0.36749, End C: 0.36750, Step C:0.00001, Step T:5.00, Delay:0.00, Trig V:0.01, Last C:0.00000	

Set →
 → Query

4-18-3. :OCP[:CHANnel]:NUMBer

Description	Setting and query for the OCP memory number. (Contents of OCP.No:)
Setting syntax	:OCP[:CHANnel]:NUMBer <NR1>
Setting parameter	<NR1> Sets the OCP memory number
Setting example	:OCP:NUMB 1 Sets the OCP number is 1.
Query syntax	:OCP[:CHANnel]:NUMBer?
Return parameter	<NR1> Returns the OCP memory number.
Query example	:OCP:NUMB? 1 The OCP number is 1.

Set →
 → Query

4-18-4. :OCP:MEMO

Description	Setting and query for user-created note of the currently selected OCP function.
Setting syntax	:OCP:MEMO <string>
Setting parameter	<string> Set the OCP note.
Setting example	:OCP:MEMO abc Set the OCP note is "abc".
Query syntax	:OCP:MEMO?
Return parameter	<string> Return the OCP note.
Query example	:OCP:MEMO? abc The OCP note is "abc".

Set →

→ Query

4-18-5. :OCP[:CHANnel]:RANGe

Description	Setting and query for the channel range. (Contents of Range:)	
Setting syntax	:OCP[:CHANnel]:RANGe {LOW MIDDLE HIGH}	
Setting parameter	LOW	CC Mode Low range.
	MIDDLE	CC Mode Middle range.
	HIGH	CC Mode High range.
Setting example	:OCP:RANG LOW Set CC Mode Low range.	
Query syntax	:OCP[:CHANnel]:RANGe?	
Return parameter	LOW MIDDLE HIGH	Return the OCP test current range.
Query example	:OCP:RANG? Low The range is CC Mode Low range.	

Set →

→ Query

4-18-6. :OCP[:CHANnel]:STARt

Description	Setting and query for the starting current value. (Contents of Start C:)	
Setting syntax	:OCP[:CHANnel]:STARt {<NR2> MINimum MAXimum}	
Setting parameter	<NR2>	The START current value in Amps.
	MINimum	Minimum starting current value.
	MAXimum	Maximum starting current value.
Setting example	:OCP:STAR 2 Set the start current to 2A.	
Query syntax	:OCP[:CHANnel]:STARt?	
Return parameter	<NR2>	Return the START current value in Amps.
Query example	:OCP:STAR? 0.1000 Returns the starting current as 0.1A.	

Set →
 → Query

4-18-7. :OCP[:CHANnel]:END

Description	Setting and query for the ending current value of the test. The value must be higher than the DUT OCP value. (Contents of End C:)	
Setting syntax	:OCP[:CHANnel]:END {<NR2> MINimum MAXimum}	
Setting parameter	<NR2>	The END current value in Amps.
	MINimum	Minimum ending current value.
	MAXimum	Maximum ending current value.
Setting example	:OCP:END 2 Set the END current to 2A.	
Query syntax	:OCP[:CHANnel]:END?	
Return parameter	<NR2>	Return the END current value in Amps.
Query example	:OCP:END? 0.1000 Returns the END current as 0.1A.	

Set →
 → Query

4-18-8. :OCP[:CHANnel]:STEP:CURRent

Description	Setting and query for the current step resolution of the OCP Test Automation. (Contents of Step C:)	
Setting syntax	:OCP[:CHANnel]:STEP:CURRent {<NR2> MINimum MAXimum}	
Setting parameter	<NR2>	The current value in Amps.
	MINimum	Minimum current step resolution.
	MAXimum	Maximum current step resolution.
Setting example	:OCP:STEP:CURR 0.1 Set the step resolution as 0.1A.	
Query syntax	:OCP[:CHANnel]:STEP:CURRent?	
Return parameter	<NR2>	Returns the current step resolution in Amps.
Query example	:OCP:STEP:CURR? 0.1000 Returns the step resolution as 0.1A.	

Set →

→ Query

4-18-9. :OCP[:CHANnel]:STEP:TIME

Description	Setting and query for how long the step times of the OCP Test Automation function. (Contents of Step T:)	
Setting syntax	:OCP[:CHANnel]:STEP:TIME	
Setting parameter	{<NR2> MINimum MAXimum}	
	<NR2>	The step time in seconds.
	MINimum	Minimum step times.
	MAXimum	Maximum step times.
Setting example	:OCP:STEP:TIME 2 Set the step time to 2second.	
Query syntax	:OCP[:CHANnel]:STEP:TIME?	
Return parameter	<NR2>	Return the step time in seconds.
Query example	:OCP:STEP:TIME? 0.10 Returns the step time.	

Set →

→ Query

4-18-10. :OCP[:CHANnel]:DELay

Description	Setting and query for the test delay time of the OCP Test Automation function. (Contents of Delay:)	
Setting syntax	:OCP[:CHANnel]:DELay {<NR2> MINimum MAXimum}	
Setting parameter	<NR2>	
	<NR2>	The delay time in seconds
	MINimum	Minimum test delay time.
	MAXimum	Maximum test delay time.
Setting example	:OCP:DEL 2 Set the delay time to 2s.	
Query syntax	:OCP[:CHANnel]:DELay?	
Return parameter	<NR2>	Return the delay time in seconds.
Query example	:OCP:DEL? 0.10 Returns the delay time in seconds	

Set →
 → Query

4-18-11. :OCP[:CHANnel]:TRIGger

Description	Setting and query for the voltage trigger for when the power supply OCP has been triggered. (Contents of Trig V:)	
Setting syntax	:OCP[:CHANnel]:TRIGger {<NR2> MINimum MAXimum}	
Setting parameter	<NR2>	The trigger voltage level.
	MINimum	Minimum voltages trigger level.
	MAXimum	Maximum voltage triggers level.
Setting example	:OCP:TRIG 2 Set the trigger voltage level to 2V.	
Query syntax	:OCP[:CHANnel]:TRIGger?	
Return parameter	<NR2>	Return the trigger voltage level.
Query example	:OCP:TRIG? 2.0 Returns the trigger level.	

Set →
 → Query

4-18-12. :OCP[:CHANnel]:LAST

Description	Setting and query for the current value of after the DUT OCP protection has been activated. (Contents of last C:)	
Setting syntax	:OCP[:CHANnel]:LAST {<NR2> MINimum MAXimum}	
Setting parameter	<NR2>	The current value in Amps.
	MINimum	Minimum current value.
	MAXimum	Maximum current value.
Setting example	:OCP:LAST 2 Set the current value to 2A.	
Query syntax	:OCP[:CHANnel]:LAST?	
Return parameter	<NR2>	Returns the current value in Amps.
Query example	:OCP:LAST? 0.1000 Returns the current value.	

4-18-13. :OCP:CHANnel:STATus

→ Query

Description	Queries the status of the OCP Test Automation function.
Query syntax	:OCP:CHANnel:STATus?
Return parameter	0 Test ended 1 OCP test active
Query example	:OCP:CHAN:STAT? 0 The test has ended.

4-18-14. :OCP:RESult

→ Query

Description	Returns the OCP Test Automation results.
Query syntax	:OCP:RESult?
Return parameter	<NR2>,<NR2> Returns the OCP current, voltage.
Query example	:OCP:RES? 3.6750,0.10 OCP Current:3.675A, OCP Voltage:0.10V

4-18-15. :OCP:RUN

Set →

Description	Turns the load on for the OCP Test Automation function. Same as :INPUT ON command.
Setting syntax	:OCP:RUN

4-19. OPP Test Commands

To execute / stop the test, use: INPUT command.
 Refer to the page 21 (4-3-1.: INPUT).

Set →

→ Query

4-19-1. :OPP:STATE

Description	Setting and query for the state of the OPP function.	
Setting syntax	:OPP:STATE {<bool> OFF ON}	
Setting parameter	OFF 0	Turns the OPP function off.
	ON 1	Turns the OPP function on.
Setting example	:OPP:STATE ON	
	Turns the OPP function on.	
Query syntax	:OPP:STATE?	
Return Parameter	Return the OPP function state.	
	ON, STOP RUN END	OPP function is on. “STOP” is OPP test stop, “RUN” is OPP test running, “END” is OPP test finished.
	OFF	OPP function is off.
Query example	:OPP:STATE?	
	OFF	Indicates that the OPP function is turned off.

Set →

→ Query

4-19-2. :OPP:EDIT[:CHANnel]

Description	Setting and query for the settings of the selected OPP memory number. Parameters of "OPP Function"	
Setting syntax	:OPP:EDIT[:CHANnel](1),(2),(3),(4),(5),(6),(7),(8),(9)	
Setting parameter	(1) <NR1>	Memory Number (OPP.No:1~12)
	(2) <ASCII string>	Current range (Range:) LOW MIDDLE HIGH
	(3) <NR2>	Start watt value (Start W: unit W)
	(4) <NR2>	End watt value (End W: unit W)
	(5) <NR2>	Watt step value (Step W: unit W)
	(6) <NR2>	Time step value (Step T:unit s)
	(7) <NR2>	Delay time value (Delay: unit s)
	(8) <NR2>	Trigger voltage (Trig V:unit V)
	(9) <NR2>	Steady state watt after test has finished (last W:unit W)
Setting example	:OPP:EDIT 1, LOW, 0.5, 5.0, 0.1, 0.25, 0, 5.0, 1.0	
Query syntax	:OPP:EDIT[:CHANnel]?	
Return Parameter	In the following order, return all the settings for the selected OPP memory number.	
	(1) Temp:Seq_<NR1>	OPP.No:1~12.
	(2) Range: High Middle Low	Current range.
	(3) Start W:<NR2>	Start watt value.
	(4) End W:<NR2>	End watt value.
	(5) Step W:<NR2>	Watt step value.
	(6) Step T:<NR2>	Time step value.
	(7) Delay: <NR2>	Delay time value.
	(8) TrigV :<NR2>	Trigger voltage.
	(9) Last W:<NR2>	Steady state watt after test has finished.
Query example	:OPP:EDIT? Temp:Seq_1, Range: High, Start W:0.36749, End W: 0.36750, Step W:0.00001, Step T:5.00, Delay:0.00,Trig V:0.01, Last W:0.00000	

Set →
 → Query

4-19-3. :OPP[:CHANnel]:NUMBer

Description	Setting and query for the OPP memory number. (Contents of OPP.No:)
Setting syntax	:OPP[:CHANnel]:NUMBer <NR1>
Setting parameter	<NR1> Sets the OPP memory number
Setting example	:OPP:NUMB 1 Sets the OPP number is 1.
Query syntax	:OPP[:CHANnel]:NUMBer?
Return parameter	<NR1> Returns the OPP memory number.
Query example	:OPP:NUMB? 1 The OPP number is 1.

Set →
 → Query

4-19-4. :OPP:MEMO

Description	Setting and query for user-created note of the currently selected OPP function.
Setting syntax	:OPP:MEMO <string>
Setting parameter	<string> Set the OPP note.
Setting example	:OPP:MEMO abc Set the OPP note is "abc".
Query syntax	:OCP:MEMO?
Return parameter	<string> Return the OCP note.
Query example	:OCP:MEMO? abc The OCP note is "abc".

Set →

→ Query

4-19-5. :OPP[:CHANnel]:RANGe

Description	Setting and query for the channel range. (Contents of Range:)	
Setting syntax	:OPP[:CHANnel]:RANGe {LOW MIDDLE HIGH}	
Setting parameter	LOW	CC Mode Low range.
	MIDDLE	CC Mode Middle range.
	HIGH	CC Mode High range.
Setting example	:OPP:RANG LOW Set CP Mode Low range.	
Query syntax	:OPP[:CHANnel]:RANGe?	
Return parameter	LOW MIDDLE HIGH	Return the OPP test current range.
Query example	:OPP:RANG? Low The range is CP Mode Low range.	

Set →

→ Query

4-19-6. :OPP[:CHANnel]:STARt

Description	Setting and query for the starting current value. (Contents of Start W:)	
Setting syntax	:OPP[:CHANnel]:STARt {<NR2> MINimum MAXimum}	
Setting parameter	<NR2>	The START watt value in Watts.
	MINimum	Minimum starting watt value.
	MAXimum	Maximum starting watt value.
Setting example	:OPP:STAR 2 Set the start watt to 2W.	
Query syntax	:OPP[:CHANnel]:STARt?	
Return parameter	<NR2>	Return the START watt value in Watts.
Query example	:OPP:STAR? 0.1000 Returns the starting watt as 0.1W.	

Set →

→ Query

4-19-7. :OPP[:CHANnel]:END

Description	Setting and query for the ending watt value of the test. The value must be higher than the DUT OPP value. (Contents of End W:)
Setting syntax	:OPP[:CHANnel]:END {<NR2> MINimum MAXimum}
Setting parameter	<NR2> The END watt value in Amps. MINimum Minimum starting watt value. MAXimum Maximum starting watt value.
Setting example	:OPP:END 2 Set the END watt to 2A.
Query syntax	:OPP[:CHANnel]:END?
Return parameter	<NR2> Return the END watt value in Watts.
Query example	:OPP:END? 0.1000 Returns the END watt as 0.1W.

Set →

→ Query

4-19-8. :OPP[:CHANnel]:STEP:WATT

Description	Setting and query for the current step resolution of the OPP Test Automation. (Contents of Step W:)
Setting syntax	:OPP[:CHANnel]:STEP:WATT {<NR2> MINimum MAXimum}
Setting parameter	<NR2> The watt value in Watts. MINimum Minimum watt step resolution. MAXimum Maximum watt step resolution.
Setting example	:OPP:STEP:WATT 0.1 Set the step resolution as 0.1W.
Query syntax	:OPP[:CHANnel]:STEP:WATT?
Return parameter	<NR2> Returns the Watt step resolution in Watts.
Query example	:OPP:STEP:WATT? 0.1000 Returns the step resolution as 0.1W.

Set →
 → Query

4-19-9. :OCP[:CHANnel]:STEP:TIME

Description	Setting and query for how long the step times of the OPP Test Automation function. (Contents of Step T:)	
Setting syntax	:OPP[:CHANnel]:STEP:TIME	
Setting parameter	{<NR2> MINimum MAXimum}	
	<NR2>	The step time in seconds.
	MINimum	Minimum step times.
	MAXimum	Maximum step times.
Setting example	:OPP:STEP:TIME 2 Set the step time to 2second.	
Query syntax	:OPP[:CHANnel]:STEP:TIME?	
Return parameter	<NR2>	Return the step time in seconds.
Query example	:OPP:STEP:TIME? 0.10 Returns the step time.	

Set →
 → Query

4-19-10. :OPP[:CHANnel]:DELay

Description	Setting and query for the test delay time of the OPP Test Automation function. (Contents of Delay:)	
Setting syntax	:OPP[:CHANnel]:DELay {<NR2> MINimum MAXimum}	
Setting parameter	{<NR2> MINimum MAXimum}	
	<NR2>	The delay time in seconds
	MINimum	Minimum test delay time.
	MAXimum	Maximum test delay time.
Setting example	:OPP:DEL 2 Set the delay time to 2s.	
Query syntax	:OPP[:CHANnel]:DELay?	
Return parameter	<NR2>	Return the delay time in seconds.
Query example	:OPP:DEL? 0.10 Returns the delay time in seconds.	

Set →
 → Query

4-19-11. :OPP[:CHANnel]:TRIGger

Description	Setting and query for the voltage trigger for when the power supply OPP has been triggered. (Contents of Trig V:)	
Setting syntax	:OPP[:CHANnel]:TRIGger {<NR2> MINimum MAXimum}	
Setting parameter	<NR2>	The trigger voltage level.
	MINimum	Minimum voltages trigger level.
	MAXimum	Maximum voltage triggers level.
Setting example	:OPP:TRIG 2 Set the trigger voltage level to 2V.	
Query syntax	:OPP[:CHANnel]:TRIGger?	
Return parameter	<NR2>	Return the trigger voltage level.
Query example	:OPP:TRIG?	
	2.0 Returns the trigger level.	

Set →
 → Query

4-19-12. :OPP[:CHANnel]:LAST

Description	Setting and query for the watt value of after the DUT OPP protection has been activated. (Contents of last W:)	
Setting syntax	:OPP[:CHANnel]:LAST {<NR2> MINimum MAXimum}	
Setting parameter	<NR2>	The watt value in Watts.
	MINimum	Minimum watt value.
	MAXimum	Maximum watt value.
Setting example	:OPP:LAST 2 Set the watt value to 2W.	
Query syntax	:OPP[:CHANnel]:LAST?	
Return parameter	<NR2>	Returns the watt value in Watts.
Query example	:OPP:LAST?	
	0.1000 Returns the watt value.	

4-19-13. :OPP:CHANnel:STATus

→ Query

Description	Queries the status of the OPP Test Automation function.	
Query syntax	:OPP:CHANnel:STATus?	
Return parameter	0	Test ended
	1	OPP test active
Query example	:OPP:CHAN:STAT? 0 The test has ended.	

4-19-14. :OPP:RESult

→ Query

Description	Returns the OPP Test Automation results.	
Query syntax	:OPP:RESult?	
Return parameter	<NR2>,<NR2>	Returns the OPP current, voltage.
Query example	:OPP:RES? 3.6750,0.10 OPP Current:3.675A, OPP Voltage:0.10V	

4-19-15. :OCP:RUN

Set →

Description	Turns the load on for the OPP Test Automation function. Same as :INPUT ON command.	
Setting syntax	:OPP:RUN	

4-20. BATT Test Commands

To execute / stop the test, use: INPUT command.
Refer to the page 21 (4-3-1.: INPUT).

Set →

4-20-1. :BATTery:STATe

→ Query

Description	Setting and query for the state of the BATT function.	
Setting syntax	:BATTery:STATe {<Boolean> OFF ON}	
Setting parameter	OFF 0	Turns the BATT function off.
	ON 1	Turns the BATT function on.
Setting example	:BATT:STATe ON Turns the BATT function on.	
Query syntax	:BATTery:STATe?	
Return Parameter	Return the BATT function state.	
	ON, STOP RUN END	BATT function is on. “STOP” is BATT test stop, “RUN” is BATT test running, “END” is BATT test finished.
	OFF	BATT function is off.
Query example	:BATT:STATe? OFF Indicates that the BAtt function is turned off.	

Set →

→ Query

4-20-2. :BATTery:EDIT

Description	Setting and query for the settings of the selected BATT memory number. Parameters of "BATT Function".	
Setting syntax	:BATTery:EDIT(1),(2),(3),(4),(5),(6),(7),(8),(9),(10)	
Setting parameter	(1) <NR1>	Memory Number (BATT.No:1~12).
	(2) <ASCII string>	Operation mode (Mode :). CC CR CP
	(3) <ASCII string>	I and V range (Range :) ILVL IMVL IHVL ILVH IMVH IHVH
	(4) <NR2>	Setting value of operation mode (Setting :).
	(5) <NR2>	Rising slew rate (Slew Rate↑ : unit mA/us).
	(6) <NR2>	Falling slew rate (Slew Rate↓ : unit mA/us).
	(7) <NR2>	Stop Voltage (Stop Volt: unit V).
	(8) <NR2>	Stop Time (Stop Time: unit s).
	(9) <NR2>	Stop AH (Stop AH: unit Ah)
	(10) <NR2>	The time interval for data capture (Datalog timer: unit s).
Setting example	:BATT:EDIT 1, CC, ILVL, 0.1, 8.4, 8.4, 5, 50, 1	
Query syntax	:BATTery:EDIT?	
Return Parameter	In the following order, return all the settings for the selected BATT memory number.	
	(1) No:<NR1>	BATT.No:1~12.
	(2) /sMemo:<string>	BATT note.
	(3) /sMode:CC CR CP	Operation mode.
	(4) /sRange: ILVL IMVL IHVL ILVH IMVH IHVH	I and V range
	(5) /sSet:<NR2>	Setting value.
	(6) /sSRUP :<NR2>	Rising slew rate.
	(7) /sSRDW:<NR2>	Falling slew rate.
	(8) /sStop/sV:<NR2>	Stop Voltage.
	(9) /sStop/sT:<NR2>	Stop Time.
	(10) /sStop/sAH :<NR2>	Stop AH
	(11) /sDatalog:<NR2>/n	The time interval for data capture.
Query example	:BATT:EDIT? No:01,/sMemo:./sMode:CC,/sRange:ILVL,/sSet:0.0000,/sSRUP:250,/sSRDW:250,/sStop/sV:1.500,/sStop/sT:0,/sStop/sAH:0.20,/sDatalog:1/n	

Set →

→ Query

4-20-3. :BATTery [:CHANnel]:NUMBer

Description	Setting and query for the BATT memory number. (Contents of BATT.No:)
Setting syntax	:BATTery[:CHANnel]:NUMBer <NR1 >
Setting parameter	<NR1> Sets the BATT memory number
Setting example	:BATT:NUMB 1 Sets the BATT number is 1.
Query syntax	:BATTery[:CHANnel]:NUMBer?
Return parameter	<NR1> Returns the BATT memory number.
Query example	:BATT:NUMB? 1 The BATT number is 1.

Set →

→ Query

4-20-4. :BATTery:MEMO

Description	Setting and query for user-created note of the currently selected BATT function.
Setting syntax	:BATTery:MEMO <string>
Setting parameter	<string> Set the BATT note.
Setting example	:BATT:MEMO abc Set the BATT note is "abc".
Query syntax	:BATTery:MEMO?
Return parameter	<string> Return the BATT note.
Query example	:BATT:MEMO? abc The BATT note is "abc".

Set →

→ Query

4-20-5. :BATTery:MODE

Description	Setting and query for the operation mode. (Contents of Mode:)	
Setting syntax	:BATTery:MODE {CC CR CP}	
Setting parameter	CC	Set the CC mode.
	CR	Set the CR mode.
	CP	Set the CP mode.
Setting example	:BATT:MODE CC Set the operation mode to CC.	
Query syntax	:BATTery:MODE?	
Return parameter	CC CR CP	Return the operation mode.
Query example	: BATT:MODE? CC The operation mode is CC.	

Set →

→ Query

4-20-6. :BATTery:RANGe

Description	Setting and query for the channel range. (Contents of Range:)	
Setting syntax	:BATTery:RANGe {ILVL IMVL IHVL ILVH IMVH IHVH}	
Setting parameter	ILVL	Set the I range is L, and V range is L.
	IMVL	Set the I range is M, and V range is L.
	IHVL	Set the I range is H, and V range is L.
	ILVH	Set the I range is L, and V range is H.
	IMVH	Set the I range is M, and V range is H.
	IHVH	Set the I range is H, and V range is H.
Setting example	:BATT:RANG ILVL Set the range are I range L, and V range L.	
Query syntax	:BATTery:RANGe?	
Return parameter	ILVL IMVL IHVL ILVH IMVH IHVH	Return the BATT test I and V range.
Query example	:BATT:RANG? ILVL The setting range is I range L, and V range L.	

Set →

→ Query

4-20-7. :BATTery:VALue

Description	Setting and query for the setting value of the selected operation mode. (Contents of Setting:)	
Setting syntax	:BATTery:VALue {<NR2> MINimum MAXimum}	
Setting parameter	<NR2>	The setting value
	MINimum	Minimum setting value.
	MAXimum	Maximum setting value.
Setting example	:BATT:VAL 2 Set the value to 2A.	
Query syntax	:BATTery:VALue?	
Return parameter	<NR2>	Return the setting value.
Query example	:BATT:VAL? 2 Returns the starting current as 2A.	

Set →

→ Query

4-20-8. :BATTery:RISE

Description	Setting and query for the test rising slew rate in mA/us. (Contents of Slew Rate J:)	
Setting syntax	:BATTery:RISE {<NR2> MINimum MAXimum}	
Setting parameter	<NR2>	The test rising slew rate.
	MINimum	Minimum test rising slew rate.
	MAXimum	Maximum test rising slew rate.
Setting example	:BATT:RISE 8.4 Set the test rising slew to 8.4mA/us.	
Query syntax	:BATTery:RISE?	
Return parameter	<NR2>	Return the test rising slew.
Query example	:BATT:RISE? 8.4 Returns the test rising slew as 8.4mA/us.	

Set →

→ Query

4-20-9. :BATTery:FALL

Description	Setting and query for the test falling slew rate in mA/us. (Contents of Slew Rate ↓:)	
Setting syntax	:BATTery:FALL {<NR2> MINimum MAXimum}	
Setting parameter	<NR2>	The test falling slew rate.
	MINimum	Minimum test falling slew rate.
	MAXimum	Maximum test falling slew rate.
Setting example	:BATT:FALL 8.4 Set the test falling slew to 8.4mA/us.	
Query syntax	:BATTery:FALL?	
Return parameter	<NR2>	Return the test falling slew.
Query example	:BATT:FALL? 8.4 Returns the test falling slew as 8.4mA/us.	

Set →

→ Query

4-20-10. :BATTery:STOP:VOLTage

Description	Setting and query for the voltage at which the test should be interrupted. (Contents of Stop Volt:)	
Setting syntax	:BATTery:STOP:VOLTage {<NR2> MINimum MAXimum}	
Setting parameter	<NR2>	The stop voltage in V.
	MINimum	Minimum stop voltage.
	MAXimum	Maximum stop voltage.
Setting example	:BATT:STOP:VOLT 5 Set the stop voltage to 5V.	
Query syntax	:BATTery:STOP:VOLTage?	
Return parameter	<NR2>	Return the stop voltage in V.
Query example	:BATT:STOP:VOLT? 5 Returns the stop voltage as 5V.	

Set →
 → Query

4-20-11. :BATTery:STOP:TIME

Description	Setting and query for the time after which the test should be interrupted. (Contents of Stop Time:)	
Setting syntax	:BATTery:STOP:TIME {<NR1> MINimum MAXimum OFF}	
Setting parameter	<NR1>	The stop time in seconds. (0~3599999)
	MINimum	Minimum stop times.
	MAXimum	Maximum stop times.
	OFF	"OFF" is 0 second.
Setting example	:BATT:STOP:TIME 2 Set the stop time to 2second.	
Query syntax	:BATTery:STOP:TIME?	
Return parameter	<NR1>	Return the stop time in seconds.
Query example	:OPP:STOP:TIME? 2 Returns the step time as 2 seconds.	

Set →
 → Query

4-20-12. :BATTery:STOP:AH

Description	Setting and query for the discharged energy rate at which the test should be interrupted. (Contents of Stop AH:)	
Setting syntax	:BATTery:STOP:AH {<NR2> MINimum MAXimum OFF}	
Setting parameter	<NR2>	The stop AH in Ah. (0~9999.99)
	MINimum	Minimum stop AH.
	MAXimum	Maximum stop AH.
	OFF	"OFF" is 0 AH.
Setting example	:BATT:STOP:AH 2 Set the stop AH to 2 Ah.	
Query syntax	:BATTery:STOP:AH?	
Return parameter	<NR2>	Return the stop AH in Ah.
Query example	:OPP:STOP:AH? 2 Returns the step AH as 2 Ah.	

Set →
 → Query

4-20-13. :BATTery:DATalog:TIMer

Description	Setting and query for the time interval for data capture. (Contents of Datalog timer:)	
Setting syntax	:BATTery:DATalog:TIMer {<NR1> MINimum MAXimum}	
Setting parameter	<NR1>	The interval time in seconds. (1~120)
	MINimum	Minimum interval times.
	MAXimum	Maximum interval times.
Setting example	:BATT:DAT:TIM 2 Set the interval time to 2 seconds.	
Query syntax	:BATTery:DATalog:TIMer?	
Return parameter	<NR1>	Return the interval time in seconds.
Query example	:OPP:DAT:TIM? 2 Returns the interval time as 2 seconds.	

4-20-14. :BATTery:CHANnel:STATus

→ Query

Description	Queries the status of the BATT Test Automation function.	
Query syntax	:BATTery:CHANnel:STATus?	
Return parameter	0	Test ended
	1	BATT test active
Query example	:BATT:CHAN:STAT? 0 The test has ended.	

4-20-15. :BATTery:RESult

→ Query

Description	Returns the BATT Test Automation results.
Query syntax	:BATTery:RESult?
Return parameter	<NR2>,<NR2> Returns the BATT current, voltage.
Query example	:BATT:RES? 3.6750,0.10 BATT Current:3.675A, BATT Voltage:0.10V

4-20-16. :BATTery:RUN

Set →

Description	Turns the load on for the BATT Test Automation function. Same as :INPUT ON command.
Setting syntax	:BATTery:RUN

4-21. Utility Commands

4-21-1. :UTILity:SYSTem

→ Query

Description	Query for model number, serial number, and firmware version.	
Query syntax	:UTILity:SYSTem?	
Return parameter	<ASCII string>	Return the model name.
	<NR1>	Return the serial number.
	<ASCII string>	Return the firmware version.
Query example	:UTIL:SYST? >LSG-175H,12345678,V1.01.001 Return the model number, serial number, and firmware version.	

Set →

4-21-2. :UTILity:LOAD

→ Query

Description	Setting and query for Auto Load and load function at power on. (Contents of Auto Load and Auto Load On) Parameters of "Load Setting For Power On"	
Setting syntax	:UTILity:LOAD {ON OFF LOAD PROG NSEQ FSEQ}	
Setting parameter	ON	Turn on Auto Load.
	OFF	Turn off Auto Load.
	LOAD	Sets to manual operation.
	PROG	Sets to program function.
	NSEQ	Sets to normal sequence function.
	FSEQ	Sets to fast sequence function.
Setting example 1	:UTIL:LOAD ON Sets on the manual operation at power on.	
Setting example 2	:UTIL:LOAD PROG Sets to the program function at power on.	
Query syntax	:UTILity:LOAD?	
Return parameter	Load:On Off, Load On: Load Prog NSeq FSeq	Return the Auto Load and load function at power on, by the string.
Query example	:UTIL:LOAD? >Load:Off, Load On:Prog Return the Auto Load and load function at power on.	

Set →

→ Query

4-21-3. :UTILity:LOAD:MODE

Description	Setting and query for the Load Off (Mode) setting. Parameters of "Load Setting For Power On"
Setting syntax	:UTILity:LOAD:MODE {<Boolean> ON OFF}
Setting parameter	ON 1 Sets Load Off (Mode) to ON. OFF 0 Sets Load Off (Mode) to OFF.
Setting example	:UTIL:LOAD:MODE ON Turns Load Off (Mode) to on.
Query syntax	:UTILity:LOAD:MODE?
Return parameter	On Off Return the Load Off (Mode) setting.
Query example	:UTIL:LOAD:MODE? >Off Load Off (Mode) is off.

Set →

→ Query

4-21-4. :UTILity:LOAD:RANGe

Description	Setting and query for the Load Off (Range) setting. Parameters of "Load Setting For Power On"
Setting syntax	:UTILity:LOAD:RANGe {<Boolean> ON OFF}
Setting parameter	ON 1 Sets Load Off (Range) to OFF. OFF 0 Sets Load Off (Range) to ON.
Setting example	:UTILity:LOAD:RANGe ON Turns Load Off (Range) to on.
Query syntax	:UTILity:LOAD:RANGe?
Return parameter	On Off Return the Load Off (Range) setting.
Query example	:UTILity:LOAD:RANGe? > Off Load Off (Range) is off.

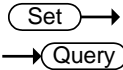

4-21-5. :UTILity:TIME

Description	Setting and query for the date and time. Parameters of "Date/Time"
Setting syntax	:UTILity:TIME (1),(2),(3),(4),(5)
Setting parameter	(1) <NR1> Sets the month. (2) <NR1> Sets the day. (3) <NR1> Sets the year. (4) <NR1> Sets the hour. (5) <NR1> Sets the minutes.
Setting example	:UTIL:TIME 9,1,2013,10,11 Sets the date and time.
Query syntax	:UTILity:TIME?
Return parameter	In the following order, return the parameters of "Date/Time". (1) <NR1> Return the month. (2) <NR1> Return the day. (3) <NR1> Return the year. (4) <NR1> Return the hour. (5) <NR1> Return the minutes.
Query example	:UTIL:TIME? >Month:9, Day:1, Year:2013, Hour:10, Minute:11 Return the date and time.

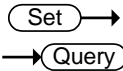

4-21-6. :UTILity:KNOB

Description	Setting and query for operational setting of the knob. Parameters of "Other Setting"
Setting syntax	:UTILity:KNOB {UPDated OLD}
Setting parameter	UPDated Sets real-time updates. OLD Sets update at the settlement after Enter.
Setting example	:UTIL:KNOB UPD Sets the operation of the knob.
Query syntax	:UTILity:KNOB?
Return parameter	Updated Old Return the operational settings of the knob, by the string.
Query example	:UTIL:KNOB? >Updated Return the operational settings of the knob.

Set →
 → Query

4-21-7. :UTILity:SPEAker

Description	Setting and query for the speakers sound during scrolling and key input. Parameters of “Other Setting”	
Setting syntax	:UTILity:SPEAker {<Boolean> ON OFF}	
Setting parameter	ON 1	Sets on the speakers sound during scrolling and key input.
	OFF 0	Sets off the speakers sound during scrolling and key input.
Setting example	:UTIL:SPEA ON Sets on the speakers sound during scrolling and key input.	
Query syntax	:UTILity: SPEAker?	
Return parameter	On Off	Return the setting value of speaker sound during scrolling and key input, by the string.
Query example	:UTIL:SPEA? >On Return the setting value of speaker sound during scrolling and key input.	

Set →
 → Query

4-21-8. :UTILity:ALARm

Description	Setting and query for the speaker sound of the alarm. Parameters of “Other Setting”	
Setting syntax	:UTILity:ALARm {<Boolean> ON OFF}	
Setting parameter	ON 1	Sets ON of the speaker sound of the alarm.
	OFF 0	Sets OFF of the speaker sound of the alarm.
Setting example	:UTIL:ALAR ON Sets the speaker sound of the alarm.	
Query syntax	:UTILity:ALARm?	
Return parameter	On Off	Return the speaker sound of the alarm, by the string.
Query example	:UTIL:ALAR? >On Return the speaker sound of the alarm.	

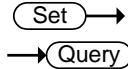

4-21-9. :UTILity:UNReg

Description	Setting and query for the speaker sound of Anne-regulation. Parameters of "Other Setting"	
Setting syntax	:UTILity:UNReg {<Boolean> ON OFF}	
Setting parameter	ON 1	Sets on the speaker sound of Anne-regulation.
	OFF 0	Sets off the speaker sound of Anne-regulation.
Setting example	:UTIL:UNR ON Sets on the speaker sound of Unregulation.	
Query syntax	:UTILity:UNReg?	
Return parameter	On Off	Return the setting value of speaker sound of Anne-regulation, by the string.
Query example	:UTIL:UNR?	
	>On Return the setting value of speaker sound of Unregulation.	

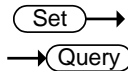

4-21-10. :UTILity:GNG

Description	Setting and query for the speaker sound of the "Go-NoGo" judgment time. Parameters of "Other Setting"	
Setting syntax	:UTILity:GNG {<Boolean> ON OFF}	
Setting parameter	ON 1	Sets ON of the speaker sound of the "Go-NoGo" judgment time.
	OFF 0	Sets OFF of the speaker sound of the "Go-NoGo" judgment time.
Setting example	:UTIL:GNG ON Sets the speaker sound of the "Go-NoGo" judgment time.	
Query syntax	:UTILity:GNG?	
Return parameter	On Off	Return the speaker sound of the "Go-NoGo" judgment time, by the string.
Query example	:UTIL:GNG?	
	>On Return the setting of the speaker sound of the "Go-NoGo" judgment time.	

Set →
 → Query

4-21-11. :UTILity:CONTRast

Description	Setting and query for the contrast of the LCD display. Parameters of "Other Setting"
Setting syntax	:UTILity:CONTRast <NR1>
Setting parameter	<NR1> Sets contrast of the LCD display. 3~13 (low ~ high)
Setting example	:UTIL:CONT 8 Sets the 8 at contrast of the LCD display.
Query syntax	:UTILity:CONTRast?
Return parameter	<NR1> Return contrast of the LCD display
Query example	:UTIL:CONT? >8 Contrast of the LCD display is 8.

Set →
 → Query

4-21-12. :UTILity:BRlghtness

Description	Setting and query for brightness of the LCD display. Parameters of "Other Setting"
Setting syntax	:UTILity:BRlghtness <NR1>
Setting parameter	<NR1> Sets brightness of the LCD display. 50~90 (low ~ high)
Setting example	:UTIL:BRI 70 Sets the 70 at brightness of the LCD display.
Query syntax	:UTILity:BRlghtness?
Return parameter	<NR1> Return brightness of the LCD display
Query example	:UTIL:BRI? >70 Brightness of the LCD display is 70.

Set →
 → Query

4-21-13. :UTILity:LANGUage

Description	Setting and query for the language of the operation panel. Note: Language is English only. Parameters of “Other Setting”
Setting syntax	:UTILity:LANGUage ENGLish
Setting parameter	ENGLish Sets to English language.
Setting example	:UTIL:LANG ENGL Sets to English language.
Query syntax	:UTILity:LANGUage?
Return parameter	English Return the language of the operation panel, by the string.
Query example	:UTIL:LANG? >English Return the language.

4-21-14. :UTILity:REMote

Set →

Description	Turns the remote control on or off.
Setting syntax	:UTILity:REMote {<Boolean> ON OFF}
Setting parameter	ON 1 Turns remote control on OFF 0 Turns Remote control off (Local)
Setting example	:UTIL:REM 1 Turns remote control on.

4-21-15. :UTILity:REMote:MODE

Set →

Description	Sets the remote mode to fast or normal. When in fast mode, the panel interface is deactivated with an interface time of no more than 10ms. Normal mode has an interface time of 30~130ms. In normal mode the display interface continues to update the screen in real-time.
Setting syntax	:UTILity:REMote:MODE {<Boolean> NORMAL FAST}
Setting parameter	NORMAL 0 NORMAL FAST 1 FAST
Setting example	:UTIL:REM:MODE 1 Turns remote mode to fast.

4-22. Interface Commands

Set →

4-22-1. :UTILity:INTerface

→ Query

Description	Setting and query for the interface. Note: Command is only valid for RS-232Control and USB. Sets after the transmission, but require power cycle to enable the feature.
Setting syntax	:UTILity:INTerface {USB RS232}
Setting parameter	USB Sets the USB interface. RS232 Sets the RS-232C interface.
Setting example	:UTIL:INT RS232 Sets the RS-232C interface.
Query syntax	:UTILity:INTerface?
Return parameter	USB RS232 Return the interface setting.
Query example	:UTIL:INT? >RS232 The interface setting is RS232C.

Set →

4-22-2. :UTILity:BRATe

→ Query

Description	Setting and query for the baud rate of RS-232C. Note: Command is only valid for interface setting of RS-232C
Setting syntax	:UTILity:BRATe {2400 4800 9600 19200 38400}
Setting parameter	<NR1> Sets the baud rate.
Setting example	:UTIL:BRAT 38400 Sets the baud rate.
Query syntax	:UTILity:BRATe?
Return parameter	<NR1> Return the baud rate.
Query example	:UTIL:BRAT? >38400 The baud rate is 38400.

Set →
 → Query

4-22-3. :UTILity:SBIT

Description	Setting and query for the stop bit of the RS-232C interface. Note: Command is only valid for interface setting of RS232C
Setting syntax	:UTILity:SBIT {1 2}
Setting parameter	<NR1> Sets the stop bit.
Setting example	:UTIL:SBIT 1 Sets the stop bit.
Query syntax	:UTILity:SBIT?
Return parameter	1 2 Return the stop bit
Query example	:UTIL:SBIT? >1 The stop bit is 1.

Set →
 → Query

4-22-4. :UTILity:PARity

Description	Setting and query for the parity bit of RS-232C interface. Note: Command is only valid for interface setting of RS-232C
Setting syntax	:UTILity:PARity {NONE ODD EVEN}
Setting parameter	NONE Sets no parity. ODD Sets the odd parity. EVEN Sets the even parity.
Setting example	:UTIL:PAR NONE Sets no parity.
Query syntax	:UTILity:PARity?
Return parameter	None Odd Even Return the parity bit of RS-232C interface, by the string.
Query example	:UTIL:PAR? >None The setting of parity is None.

4-23. File Commands

4-23-1. :MEMory:SAVE

Set →

Description	Save in the internal memory of the specified.
Setting syntax	:MEMory:SAVE < NR1>
Setting parameter	<NR1> Specify the internal memory number. (1 to 256)
Setting example	:MEM:SAVE 20 Saves the current setting to internal memory 20.
Same function command	*SAV

4-23-2. :MEMory:RECall

Set →

Description	Recall settings from the internal memory.
Setting syntax	:MEMory:RECall <NR1>
Setting parameter	<NR1> Specify the internal memory number. (1 to 256)
Setting example	:MEM:REC 20 Recall setting internal memory 20.
Same function command	*RCL

4-23-3. :PREset:SAVE

Set →

Description	Save to the preset memory of the specified.
Setting syntax	:PREset:SAVE < NR1>
Setting parameter	<NR1> Specify the preset memory number. (0 to 9)
Setting example	:PRE:SAVE 1 Saves the setting value to preset memory 1.

4-23-4. :PREset:RECall

Set →

Description	Recall settings from the preset memory.
Setting syntax	:PREset:RECall <NR1>
Setting parameter	<NR1> Specify the preset memory number. (0 to 9)
Example	:PRE:REC 1 Recall setting preset memory 1.

4-23-5. :SETup:SAVE

Set →

Description	Save to the setup data of the specified.
Setting syntax	:SETup:SAVE <NR1>
Setting parameter	<NR1> Specify the setup data number. (1 to 100)
Setting example	:SET:SAVE 1 Saves the setting value to setup data 1.

4-23-6. :SETup:RECall

Set →

Description	Recall settings from the setup data.
Setting syntax	:SETup:RECall <NR1>
Setting parameter	<NR1> Specify the setup data number. (1 to 100)
Setting example	:SET:REC 1 Recall setting setup data 1.

4-23-7. :FACTory[:RECall]

Set →

Description	Sets factory defaults. Note) Interface will switch to as follows. Interface:RS-232C, Baud rate:38400, Stop bit:1, parity :None
Setting syntax	:FACTory[:RECall]
Setting example	:FACT Sets factory defaults.

4-23-8. :USER[:DEFault]:SAVE

Set →

Description	Save to the default settings for the user.
Setting syntax	:USER[:DEFault]:SAVE
Setting example	:USER:SAVE Save as user default settings the current settings value.

4-23-9. :USER[:DEFault]:RECall

Set →

Description	Recall the default settings for the user.
Setting syntax	:USER[:DEFault]:RECall
Setting example	:USER:REC Recall the default settings for the user.

4-24. SCPI Status Commands

4-24-1. :SYSTem:ERRor

→ Query

Description	Queries the error queue. The last error message is return. A maximum of 32 errors are stored in the error queue.	
Query syntax	:SYSTem:ERRor?	
Return parameter	<NR1>,<string>	Returns the error queue, by the string.
Query example	:SYST:ERR? >-113, "Undefined header"	

4-24-2. :STATus:PRESet

Set →

Description	Is the setting of the initial value for the Csummary status and the Questionable status and the Operation status. PTR (positive transition) filter is set, enable register and (negative transition) NTR filter is reset.	
	Initial value of Register / Filter	Setting
	Csummary status enable	0x0000
	Csummary status PTR (positive transition)	0x7FFF
	Csummary status NTR (negative transition)	0x0000
	Operation status enable	0x0000
	Operation status PTR (positive transition)	0x7FFF
	Operation status NTR (negative transition)	0x0000
	Questionable status enable	0x0000
	Questionable status PTR (positive transition)	0x7FFF
	Questionable status NTR (negative transition)	0x0000
Setting syntax	:STATus:PRESet	
Setting example	:STAT:PRES	
	It set the initial value for the Csummary status and the Questionable status and the Operation status.	

4-25. Csummary Status Commands

Please refer to page154 (5-3.Csummary status register group).

4-25-1. :STATus:CSUMmary:CONDition

→ Query

Description	Query the Csummary Status Condition register.
Query syntax	:STATus:CSUMmary:CONDition?
Return parameter	<NR1> Return the Csummary Status Condition register, by the string.
Query example	:STAT:CSUM:COND? >1 Return the Csummary Status Condition register

Set →

4-25-2. :STATus:CSUMmary:ENABLE

→ Query

Description	Setting and query for the Event Enable register of Csummary.
Setting syntax	:STATus:CSUMmary:ENABLE <NR1>
Setting parameter	<NR1> Sets the Event Enable register of Csummary.
Setting example	:STAT:CSUM:ENAB 1 Sets the Event Enable register of Csummary.
Query syntax	:STATus:CSUMmary:ENABLE?
Return parameter	<NR1> Return the Event Enable register of Csummary.
Query example	:STAT:CSUM:ENAB? >1 Return the Event Enable register of Csummary.

4-25-3. :STATus:CSUMmary[:EVENT]

→ Query

Description	Query and setting for the Event register of Csummary.
Query syntax	:STATus:CSUMmary[:EVENT]?
Return parameter	<NR1> Return the Event register of Csummary, by the string.
Query example	:STAT:CSUM? >1 Return the Event register of Csummary.

Set →
 → Query

4-25-4. :STATus:CSUMmary:NTRansition

Description	Setting and query for detection bit of Csummary status of changes of from positive to negative.
Setting syntax	:STATus:CSUMmary:NTRansition <NR1>
Setting parameter	<NR1> Sets the detection bit of Csummary status of changes from positive to negative.
Setting example	:STAT:CSUM:NTR 1 Sets the detection bit of Csummary status of changes from positive to negative.
Query syntax	:STATus:CSUMmary:NTRansition?
Return parameter	<NR1> Return the detection bit of Csummary status of changes from positive to negative.
Query example	:STAT:CSUM:NTR? >1 Return the detection bit of Csummary status of changes from positive to negative.

Set →
 → Query

4-25-5. :STATus:CSUMmary:PTRansition

Description	Setting and query for detection bit of Csummary status of changes of from negative to positive.
Setting syntax	:STATus:CSUMmary:PTRansition <NR1>
Setting parameter	<NR1> Sets the detection bit of Csummary status of changes from negative to positive.
Setting example	:STAT:CSUM:PTR 1 Sets the detection bit of Csummary status of changes from negative to positive.
Query syntax	:STATus:CSUMmary:PTRansition?
Return parameter	<NR1> Return the detection bit of Csummary status of changes from negative to positive.
Query example	:STAT:CSUM:PTR? >1 Return the detection bit of Csummary status of changes from negative to positive.

4-26. Operation Status Commands

Please refer to page 156 (5-4. Operation status register group).

4-26-1. :STATus:OPERation:CONDition

→ Query

Description	Query the Operation Status Condition register.
Query syntax	:STATus:OPERation:CONDition?
Return parameter	<NR1> Return the Operation Status Condition register, by the string.
Query example	:STAT:OPER:COND? >1 Return the Operation Status Condition register.

Set →

4-26-2. :STATus:OPERation:ENABLE

→ Query

Description	Setting and query for the Event Enable register of Operation.
Setting syntax	:STATus:OPERation:ENABLE <NR1>
Setting parameter	<NR1> Sets the Event Enable register of Operation.
Setting example	:STAT:OPER:ENAB 1 Sets the Event Enable register of Operation.
Query syntax	:STATus:OPERation:ENABLE?
Return parameter	<NR1> Return the Event Enable register of Operation.
Query example	:STAT:OPER:ENAB? >1 Return the Event Enable register of Operation.

4-26-3. :STATus:OPERation[:EVENT]

→ Query

Description	Query for the Event register of Operation.
Query syntax	:STATus:OPERation[:EVENT]?
Return parameter	<NR1> Return the Event register of Operation, by the string.
Query example	:STAT:OPER? >1 Return the Event register of Operation.

Set →
 → Query

4-26-4. :STATus:OPERation:NTRansition

Description	Setting and query for detection bit of Operation status of changes of from positive to negative.
Setting syntax	:STATus OPERation:NTRansition <NR1>
Setting parameter	<NR1> Sets the detection bit of Operation status of changes from positive to negative.
Setting example	:STAT:OPER:NTR 1 Sets the detection bit of Operation status of changes from positive to negative.
Query syntax	:STATus:OPERation:NTRansition?
Return parameter	<NR1> Return the detection bit of Operation status of changes from positive to negative.
Query example	:STAT:OPER:NTR? >1 Return the detection bit of Operation status of changes from positive to negative.

Set →
 → Query

4-26-5. :STATus:OPERation:PTRansition

Description	Setting and query for detection bit of Operation status of changes of from negative to positive.
Setting syntax	:STATus:OPERation:PTRansition <NR1>
Setting parameter	<NR1> Sets the detection bit of Operation status of changes from negative to positive.
Setting example	:STAT:OPER:PTR 1 Sets the detection bit of Operation status of changes from negative to positive.
Query syntax	:STATus:OPERation:PTRansition?
Return parameter	<NR1> Return the detection bit of Operation status of changes from negative to positive.
Query example	:STAT:OPER:PTR? >1 Return the detection bit of Operation status of changes from negative to positive.

4-27. Questionable Status Commands

Please refer to page 157 (5-5.Questionable Status Register Group).

4-27-1. :STATus:QUEStionable:CONDition

→ Query

Description	Query the Questionable Status Condition register.
Query syntax	:STATus:QUEStionable:CONDition?
Return parameter	<NR1> Return the Questionable Status Condition register, by the string.
Query example	:STAT: QUES:COND? >1 Return the Questionable Status Condition register.

Set →

4-27-2. :STATus:QUEStionable:ENABLE

→ Query

Description	Setting and query for the Event Enable register of Questionable.
Setting syntax	:STATus:QUEStionable:ENABLE <NR1>
Setting parameter	<NR1> Sets the Event Enable register of Questionable.
Setting example	:STAT:QUES:ENAB 1 Sets the Event Enable register of Questionable.
Query syntax	:STATus:QUEStionable:ENABLE?
Return parameter	<NR1> Return the Event Enable register of Questionable.
Query example	:STAT:QUES:ENAB? >1 Return the Event Enable register of Questionable.

4-27-3. :STATus:QUEStionable[:EVENT]

→ Query

Description	Query for the Event register of Questionable.
Query syntax	:STATus:QUEStionable[:EVENT]?
Return parameter	<NR1> Return the Event register of Questionable, by the string.
Query example	:STAT:QUES? >1 Return the Event register of Questionable.

Set →
 → Query

4-27-4. :STATus:QUEStionable:NTRansition

Description	Setting and query for detection bit of Questionable status of changes of from positive to negative.
Setting syntax	:STATus:QUEStionable:NTRansition <NR1>
Setting parameter	<NR1> Sets the detection bit of Questionable status of changes from positive to negative.
Setting example	:STAT:QUES:NTR 1 Sets the detection bit of Questionable status of changes from positive to negative.
Query syntax	:STATus:QUEStionable:NTRansition?
Return parameter	<NR1> Return the detection bit of Questionable status of changes from positive to negative.
Query example	:STAT:QUES:NTR? >1 Return the detection bit of Questionable status of changes from positive to negative.

Set →
 → Query

4-27-5. :STATus:QUEStionable:PTRansition

Description	Setting and query for detection bit of Questionable status of changes of from negative to positive.
Setting syntax	:STATus:QUEStionable:PTRansition <NR1>
Setting parameter	<NR1> Sets the detection bit of Questionable status of changes from negative to positive.
Setting example	:STAT:QUES:PTR 1 Sets the detection bit of Questionable status of changes from negative to positive.
Query syntax	:STATus:QUEStionable:PTRansition?
Return parameter	<NR1> Return the detection bit of Questionable status of changes from negative to positive.
Query example	:STAT:QUES:PTR? >1 Return the detection bit of Questionable status of changes from negative to positive.

5. Status Register Overview

This chapter explains in detail how the Status registers are used and how to configure them.

It will also be able to create an effective program by understand the Status register.

5-1. Introduction to the Status Registers

Overview The status registers are used to know the status of this unit. It is maintain the status of the protection conditions, operation conditions and unit errors.

The LSG Series have a number of register groups.

Csummary Status Register Group

Operation Status Register Group

Questionable Status Register Group

Standard Event Status Register Group

Status Byte Register Group

5-2. Configuration in the Status register

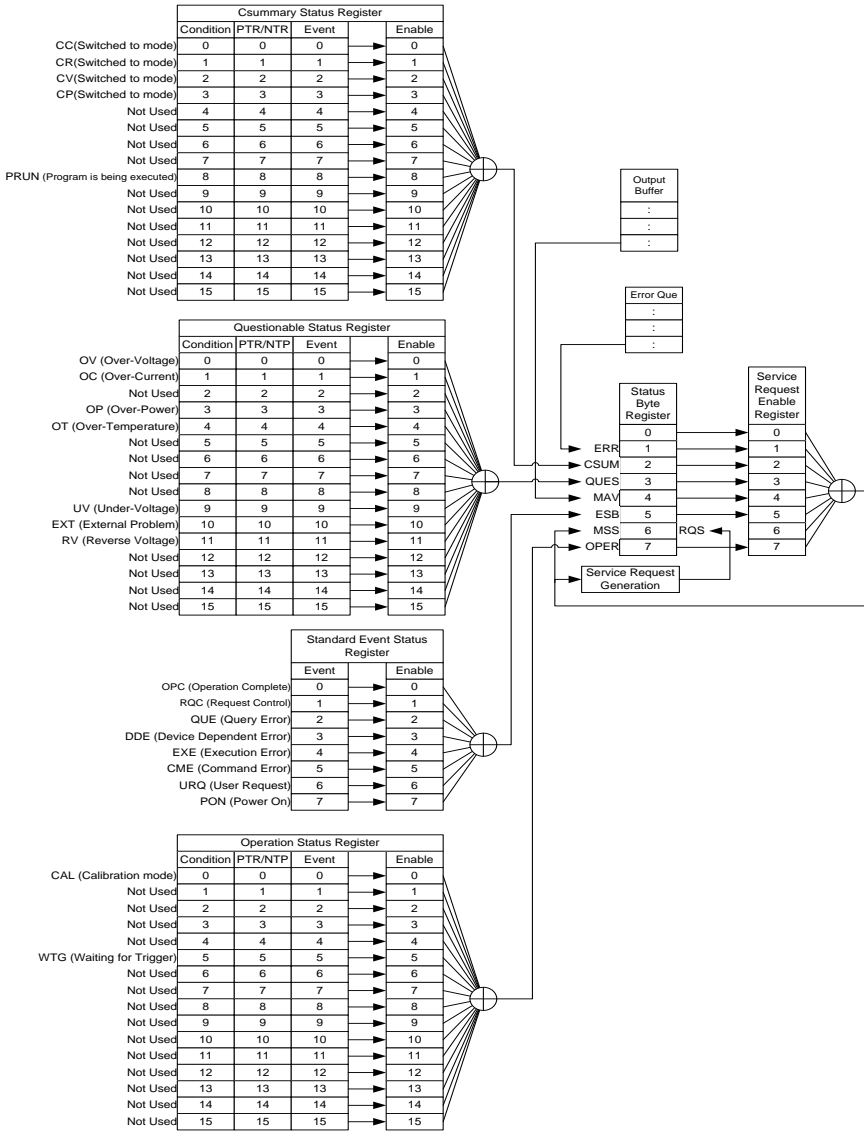

5-3. Csummary Status Register Group

Overview Csummary Status register group, you can check the operating status of the load mode and sequence or program mode.

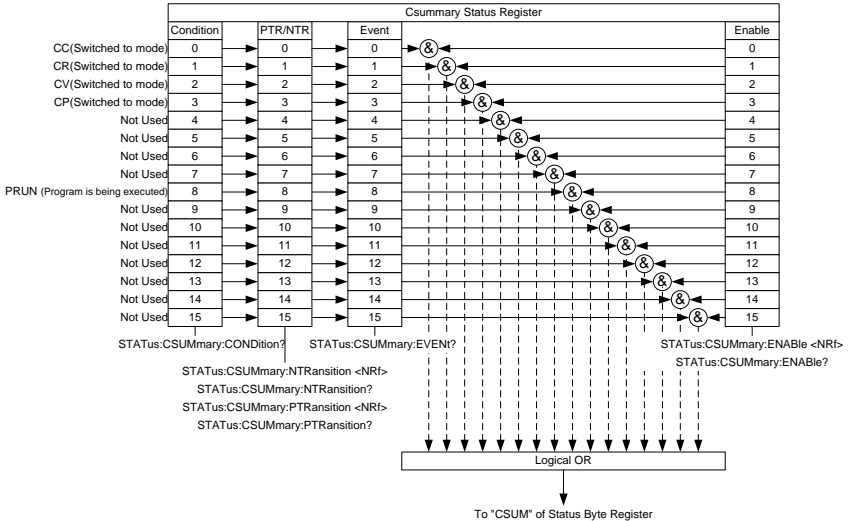

Bit Summary	Bit name	Event	Bit #	Bit Weight
	CC	Indicate the Constant Current mode setting.	0	1
	CR	Indicate the Constant Resistance mode setting.	1	2
	CV	Indicate the Constant Voltage mode setting.	2	4
	CP	Indicate the Constant Power mode setting.	3	8
	PRUN	Indicate the operation mode of Sequence or Program.	8	256
Condition Register	Csummary Status Condition register can be read the current state of the load mode and program mode or sequence operation mode.			
PTR/NTR Filter	The PTR/NTR (Positive/Negative transition) register determines the type of transition conditions that will set the corresponding bit in the Event Registers. Use the Positive transition filter to view events that change from false to positive, and use the negative transition filter to view events that change from positive to negative.			
		Positive Transition	0→1	
		Negative Transition	1→0	

Event Register	The PTR/NTR Register will dictate the type of transition conditions will set the corresponding bits in the Event Register. If the Event Register is read, it will be cleared to 0.
Enable Register	The Enable register determines which Events in the Event Register will be used to set the CSUM bit in the Status Byte Register.

5-4. Operation Status Register Group

Overview Operation Status register group, you can check the operating status of the Trigger wait or the Calibration mode.

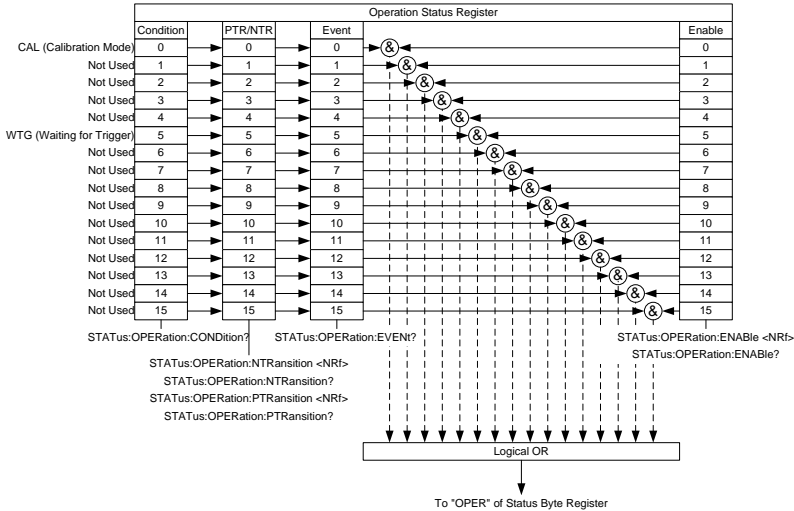

Bit Summary	Bit name	Event	Bit #	Bit Weight
	CAL	Indicate the Calibration mode.	0	1
	WTG	Indicate the Trigger wait.	5	32
Condition Register	Operation Status Condition register can be read by the current state of the Trigger waiting and Calibration mode.			
PTR/NTR Filter	The PTR/NTR (Positive/Negative transition) register determines the type of transition conditions that will set the corresponding bit in the Event Registers. Use the Positive transition filter to view events that change from false to positive, and use the negative transition filter to view events that change from positive to negative.			
	Positive Transition		0→1	
	Negative Transition		1→0	
Event Register	The PTR/NTR Register will dictate the type of transition conditions will set the corresponding bits in the Event Register. If the Event Register is read, it will be cleared to 0.			
Enable Register	The Enable register determines which Events in the Event Register will be used to set the OPER bit in the Status Byte Register.			

5-5. Questionable Status Register Group

Overview Questionable Status register group, you can check the operating status of the protection function.

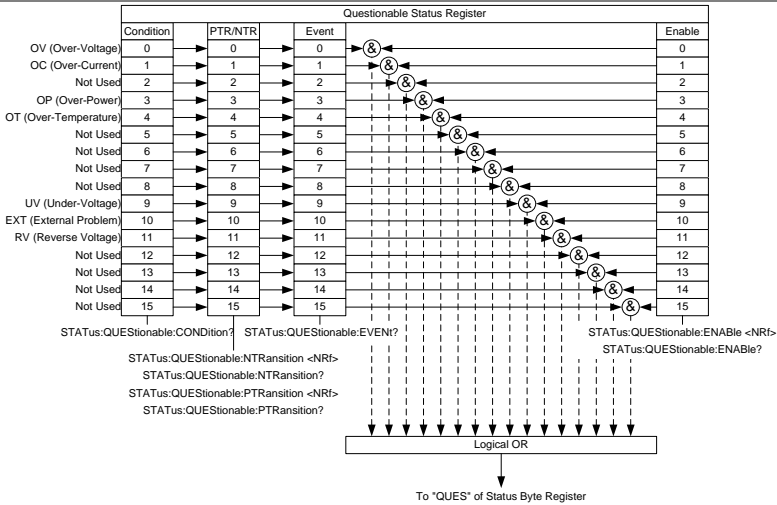

Bit Summary	Bit name	Event	Bit #	Bit Weight
	OV	Indicate the Over-Voltage condition.	0	1
	OC	Indicate the Over-Current condition.	1	2
	OP	Indicate the Over-Power condition.	3	8
	OT	Indicate the Over-Temperature condition.	4	16
	UV	Indicate the Under-Voltage condition.	9	512
	EXT	Indicate the abnormality state of the external control.	10	1024
	RV	Indicate the reverse connection state.	11	2048
Condition Register	Questionable Status Condition register can be read the current state of the protection function.			
PTR/NTR Filter	The PTR/NTR (Positive/Negative transition) register determines the type of transition conditions that will set the corresponding bit in the Event Registers. Use the Positive transition filter to view events that change from false to positive, and use the negative transition filter to view events that change from positive to negative.			
	Positive Transition	0→1		
	Negative Transition	1→0		

Event Register	The PTR/NTR Register will dictate the type of transition conditions will set the corresponding bits in the Event Register. If the Event Register is read, it will be cleared to 0.
Enable Register	The Enable register determines which Events in the Event Register will be used to set the QUES bit in the Status Byte Register.

5-6. Standard Event Status Register Group

Overview Standard Event Status register group indicates whether an error occurred. Bit in the event register is set by the error event queue.

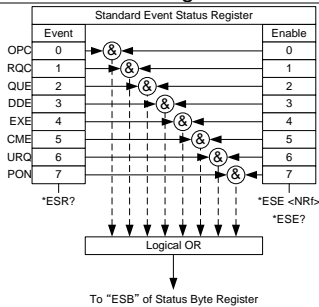

Bit Summary	Bit name	Event	Bit #	Bit Weight
	OPC	Operation complete The OPC bit is set when all selected pending operations are complete. This bit is set in response to the *OPC command.	0	1
	RQC	Request control	1	2
	QUE	Query Error The Query Error bit is set in response to an error reading the Output Queue. This can be caused by trying to read the Output Queue when there is no data present.	2	4
	DDE	Device Dependent Error Device specific error.	3	8
	EXE	Execution Error The EXE bit indicates an execution error due to one of the following: illegal command parameter, parameter out of range, invalid parameter, the command didn't execute due to an overriding operation condition.	4	16
	CME	Command Error The CME bit is set when a syntax error has occurred. The CME bit can also be set when a <GET> command is received within a program message.	5	32
	URQ	User Request	6	64
	PON	Power On Indicates the power is turned on.	7	128

Event Register	Any bits set in the event register indicate that an error has occurred. Reading the Event register will reset the register to 0.
Enable Register	The Enable register determines which Events in the Event Register will be used to set the ESB bit in the Status Byte Register.

5-7. Status Byte Register Group

Overview The Status Byte register groups, you can check the status of the event in the status register of all. You can read the status byte register in "* STB?" Query command.

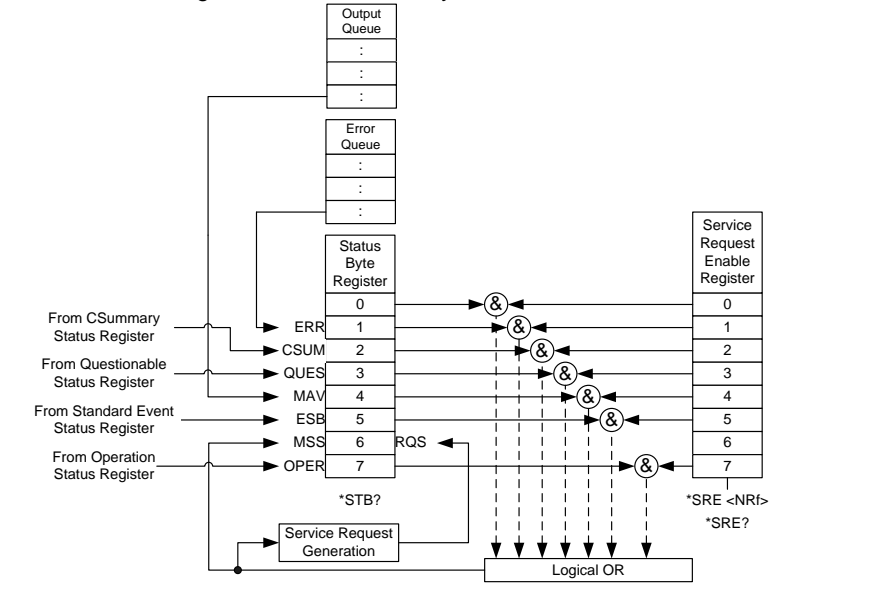

Bit Summary	Bit name	Event	Bit #	Bit Weight
	ERR	Error Event/Queue If data is present in the Error queue, the ERR bit will be set.	1	2
	CSUM	Csummary Status Register The summary bit for the Csummary Status Register group.	2	4
	QUES	Questionable Status Register The summary bit for the Questionable Status Register group.	3	8
	MAV	Message Available This is set when there is data in the Output Queue waiting to be read.	4	16
	ESB	Event Summary Bit. The ESB is the summary bit for the Standard Event Status Register group.	5	32
	MSS /RQS	The MSS Bit is the summary of the Status Byte Register and Service Request register (bits 1-5, 7). This will be set to 1.	6	64
	OPER	Operation Status Register OPER bit is the summary bit for the Operation Status Register Group.	7	128
Status Byte Register	Any bits set in the Status byte register acts as a summary register for all the four other status registers and indicates if there is a service request, an error in the Error Queue or data in the Output Queue. Reading the Status Byte register will reset the register to 0.			
Service Request Enable Register	Service Request Enable register specifies the bits in the Status Byte register for setting the MSS / RQS bit in the Status Byte register. Also, MSS bit, can see in the "**STB?" Query command. RQS bit is used to RQS bit of the GP-IB interface managed by the service request generator a bit of MSS. RQS bit is initialized after reading.			

6. Appendix

6-1. ERROR MESSAGE

The following error messages may be encountered when reading the error queue.

Error Code and string	Description
Command Errors	
0 No Error	No error
-100 Command Error	This is the generic syntax error for devices that cannot detect more specific errors.
-101 Invalid character	A syntactic element contains a character which is invalid for that type.
-102 Syntax error	An unrecognized command or data type was encountered.
-103 Invalid separator	The parser was expecting a separator and encountered an illegal character.
-104 Data type error	The parser recognized a data element different than the one allowed.
-105 GET not allowed	A Group Execute Trigger was received within a program message.
-108 Parameter not allowed	More parameters were received than expected for the header.
-109 Missing parameter	Fewer parameters were received than required for the header.
-110 Command header error	An error was detected in the header.
-111 Header separator error	A character which is not a legal header separator was encountered while parsing the header.
-112 Program mnemonic too long	The header contains more than twelve characters.
-113 Undefined header	The header is syntactically correct, but it is undefined for this specific device.
-114 Header suffix out of range	The value of a numeric suffix attached to a program mnemonic.
-115 Unexpected number of parameters	The number of parameters received does not correspond to the number of parameters expected.
-120 Numeric data error	This error is generated when parsing a data element which appears to be numeric, including the no decimal numeric types.
-121 Invalid character in number	An invalid character for the data type being parsed was encountered.
-123 Exponent too large	The magnitude of the exponent was larger than 32000.
-124 Too many digits	The mantissa of a decimal numeric data element contained more than 255 digits excluding leading zeros.

-128 Numeric data not allowed	A legal numeric data element was received, but the device does not accept one in this position for the header
-130 Suffix error	This error, as well as errors -131 through -139, is generated when parsing a suffix.
-131 Invalid suffix	The suffix does not follow the syntax described in IEEE 488.2 or the suffix is inappropriate for this device.
-134 Suffix too long	The suffix contained more than 12 characters.
-138 Suffix not allowed	A suffix was encountered after a numeric element which does not allow suffixes.
-140 Character data error	This error is generated when parsing a character data element.
-141 Invalid character data	Either the character data element contains an invalid character or the particular element received is not valid for the header.
-144 Character data too long	The character data element contains more than twelve characters
-148 Character data not allowed	A legal character data element was encountered where prohibited by the device.
-150 String data error	This error is generated when parsing a string data element.
-151 Invalid string data	A string data element was expected, but was invalid for some reason.
-158 String data not allowed	A string data element was encountered but was not allowed by the device at this point in parsing.
-160 Block data error	This error is generated when parsing a block data element.
-161 Invalid block data	A block data element was expected, but was invalid for some reason.
-168 Block data not allowed	A legal block data element was encountered but was not allowed by the device at this point in parsing.
-170 Expression error	This error is generated when parsing an expression data element.
-171 Invalid expression	The expression data element was invalid.
-178 Expression data not allowed	A legal expression data was encountered but was not allowed by the device at this point in parsing.
-180 Macro error	This error is generated when defining a macro or executing a macro.
-181 Invalid outside macro definition	Indicates that a macro parameter placeholder (\$<number>) was encountered outside of a macro definition.
-183 Invalid inside macro definition	Indicates that the program message unit sequence, sent with a *DDT or *DMC command, is syntactically invalid.

-184 Macro parameter error Indicates that a command inside the macro definition had the wrong number or type of parameters.

Execution Errors

-200 Execution error This is the generic syntax error for devices that cannot detect more specific errors. This code indicates only that an Execution Error as defined in IEEE 488.2 has occurred.

-201 Invalid while in local Indicates that a command is not executable while the device is in local due to a hard local control

-202 Settings lost due to rtl Indicates that a setting associated with a hard local control was lost when the device changed to LOCS from REMS or to LWLS from RWLS.

-203 Command protected Indicates that a legal password-protected program command or query could not be executed because the command was disabled.

-210 Trigger error

-211 Trigger ignored Indicates that a GET, *TRG, or triggering signal was received and recognized by the device but was ignored because of device timing considerations.

-212 Arm ignored Indicates that an arming signal was received and recognized by the device but was ignored.

-213 Init ignored Indicates that a request for a measurement initiation was ignored as another measurement was already in progress.

-214 Trigger deadlock Indicates that the trigger source for the initiation of a measurement is set to GET and subsequent measurement query is received. The measurement cannot be started until a GET is received, but the GET would cause an INTERRUPTED error.

-215 Arm deadlock Indicates that the arm source for the initiation of a measurement is set to GET and subsequent measurement query is received. The measurement cannot be started until a GET is received, but the GET would cause an INTERRUPTED error.

-220 Parameter error Indicates that a program data element related error occurred.

-221 Settings conflict Indicates that a legal program data element was parsed but could not be executed due to the current device state.

-222 Data out of range Indicates that a legal program data element was parsed but could not be executed because the interpreted value was outside the legal range as defined by the device.

-223 Too much data	Indicates that a legal program data element of block, expression, or string type was received that contained more data than the device could handle due to memory or related device-specific requirements.
-224 Illegal parameter value	Used where an exact value, from a list of possibilities, was expected.
-225 Out of memory	The device has insufficient memory to perform the requested operation.
-226 Lists not same length	Attempted to use LIST structure having individual LIST's of unequal lengths.
-230 Data corrupt or stale	Possibly invalid data; new reading started but not completed since last access.
-231 Data questionable	Indicates that measurement accuracy is suspect.
-232 Invalid format	Indicates that a legal program data element was parsed but could not be executed because the data format or structure is inappropriate.
-233 Invalid version	Indicates that a legal program data element was parsed but could not be executed because the version of the data is incorrect to the device.
-240 Hardware error	Indicates that a legal program command or query could not be executed because of a hardware problem in the device.
-241 Hardware missing	Indicates that a legal program command or query could not be executed because of missing device hardware.
-250 Mass storage error	Indicates that a mass storage error occurred.
-251 Missing mass storage	Indicates that a legal program command or query could not be executed because of missing mass storage.
-252 Missing media	Indicates that a legal program command or query could not be executed because of a missing media.
-253 Corrupt media	Indicates that a legal program command or query could not be executed because of corrupt media.
-254 Media full	Indicates that a legal program command or query could not be executed because the media was full.
-255 Directory full	Indicates that a legal program command or query could not be executed because the media directory was full.
-256 File name not found	Indicates that a legal program command or query could not be executed because the file name on the device media was not found.
-257 File name error	Indicates that a legal program command or query could not be executed because the file name on the device media was in error.

-258 Media protected	Indicates that a legal program command or query could not be executed because the media was protected.
-260 Expression error	Indicates that an expression program data element related error occurred.
-261 Math error in expression	Indicates that a syntactically legal expression program data element could not be executed due to a math error.
-270 Macro error	Indicates that a macro-related execution error occurred.
-271 Macro syntax error	Indicates that that a syntactically legal macro program data sequence, according to IEEE 488.2 could not be executed due to a syntax error within the macro definition.
-272 Macro execution error	Indicates that a syntactically legal macro program data sequence could not be executed due to some error in the macro definition.
-273 Illegal macro label	Indicates that the macro label defined in the *DMC command was a legal string syntax, but could not be accepted by the device.
-274 Macro parameter error	Indicates that the macro definition improperly used a macro parameter placeholder.
-275 Macro definition too long	Indicates that a syntactically legal macro program data sequence could not be executed because the string or block contents were too long for the device to handle.
-276 Macro recursion error	Indicates that a syntactically legal macro program data sequence could not be executed because the device found it to be recursive.
-277 Macro redefinition not allowed	Indicates that a syntactically legal macro label in the *DMC command could not be executed because the macro label was already defined.
-278 Macro header not found	Indicates that a syntactically legal macro label in the *GMC? query could not be executed because the header was not previously defined.
-280 Program error	Indicates that a downloaded program-related execution error occurred.
-281 Cannot create program	Indicates that an attempt to create a program was unsuccessful. A reason for the failure might include not enough memory.
-282 Illegal program name	The name used to reference a program was invalid.
-283 Illegal variable name	An attempt was made to reference a nonexistent variable in a program.
-284 Program currently running	Certain operations dealing with programs may be illegal while the program is running.
-285 Program syntax error	Indicates that a syntax error appears in a downloaded program.
-286 Program runtime error	

- 290 Memory use error Indicates that a user request has directly or indirectly caused an error related to memory or <data handle>s, this is not the same as "bad" memory.
- 291 Out of memory
- 292 Referenced name does not exist
- 293 Referenced name already exists
- 294 Incompatible type Indicates that the type or structure of a memory item is inadequate.

Device Specific Errors

- 300 Device-specific error This is the generic device-dependent error for devices that cannot detect more specific errors.
- 310 System error Indicates that some error, termed "system error" by the device, has occurred.
- 311 Memory error Indicates some physical fault in the device's memory, such as parity error.
- 312 PUD memory lost Indicates that the protected user data saved by the *PUD command has been lost.
- 313 Calibration memory lost Indicates that nonvolatile calibration data used by the *CAL? command has been lost.
- 314 Save/recall memory lost Indicates that the nonvolatile data saved by the *SAV? command has been lost.
- 315 Configuration memory lost Indicates that nonvolatile configuration data saved by the device has been lost.
- 320 Storage fault [Indicates that the firmware detected a fault when using data storage. This error is not an indication of physical damage or failure of any mass storage element.
- 321 Out of memory An internal operation needed more memory than was available.
- 330 Self-test failed fail of Self-Test.
- 340 Calibration failed Failed of Calibration.
- 350 Queue overflow A specific code entered into the queue in lieu of the code that caused the error. This code indicates that there is no room in the queue and an error occurred but was not recorded.
- 360 Communication error This is the generic communication error.
- 361 Parity error in program message Parity bit not correct when data received.
- 362 Framing error in program message A stop bit was not detected when data was received.
- 363 Input buffer overrun Software or hardware input buffer on serial port overflows with data caused by improper or nonexistent pacing.
- 365 Time out error This is a generic device-dependent error.

Query Errors	
-400 Query error	This is the generic query error.
-410 Query INTERRUPTED	Indicates that a condition causing an INTERRUPTED Query error occurred.
-420 Query UNTERMINATED	Indicates that a condition causing an UNTERMINATED Query error occurred.
-430 Query DEADLOCKED	Indicates that a condition causing a DEADLOCKED Query error occurred.
-440 Query UNTERMINATED after indefinite response	Indicates that a query was received in the same program message after a query requesting an indefinite response was executed
Power On Event Commands	
-500 Power on	The instrument has detected an off to on transition in its power supply.
User Request Event	
-600 User request	The instrument has detected the activation of a user request local control.
Request Control Event	
-700 Request control	The instrument requested to become the active IEEE 488.1 controller-in-charge.
Operation Complete Event	
-800 Operation complete	The instrument has completed all selected pending operations in accordance with the IEEE 488.2 synchronization protocol.

6-2. Change History



TEXIO TECHNOLOGY CORPORATION

7F Towa Fudosan Shin Yokohama Bldg., 2-18-13, Shin Yokohama, Kohoku-ku,
Yokohama, Kanagawa, 222-0033, Japan.

<https://www.texio.co.jp/>
