

INSTRUCTION MANUAL

REGULATED DC POWER SUPPLY PSF SERIES

PSF-400L	PSF-400L2
PSF-800L	PSF-800LS
PSF-1200L	PSF-1600L



CONTENTS

USING THE PRODUCT SAFELY	I -IV
1. GENERAL	1
1-1. General	1
1-2. Applicable Products.....	1
1-3. Features	3
1-4. Accessories	4
2. SPECIFICATIONS.....	5
3. PRELIMINARY INSTRUCTIONS	13
4. DEVICES ON PANELS	15
4-1. Front Panel.....	15
4-2. Rear Panel	19
5. OPERATION PROCEDURES	23
5-1. Connecting AC Power Cable.....	23
5-2. Connecting Load with Output Terminals	23
5-2-1. Connection with the rear output terminals	23
5-2-2. Connection with the front output terminals	26
5-3. Operation Ranges	27
5-4. Various Setting.....	27
5-4-1. How to set voltage	28
5-4-2. How to set current.....	28
5-4-3. How to set power	28
5-4-4. How to change into power display	29
5-4-5. How to output.....	29
5-4-6. How to display the set value in outputting condition.....	30
5-4-7. How to rotate display panel by 90 degrees (for vertical installation)	31
5-4-8. How to invalidate on-panel operations (Key lock function).....	31
5-5. Various Functions Available on Menus	32
5-5-1. Preset function (01).....	33
5-5-2. OVP/OCP function (02).....	34
5-5-3. Hi- Ω function (03).....	35
5-5-4. OFF timer function (04).....	36
5-5-5. Sequence function (05).....	38
5-5-6. External control (external voltage, external resistance) (06)	41
5-5-7. External control (On/Off) (07).....	43
5-5-8. Delay function (08).....	44
5-5-9. Tracking function (09)	46
5-5-10. Master-slave function (10).....	47
5-6. Output Voltage Remote Sensing.....	49
5-7. External Control Functions	50
5-7-1. To assemble the connector XG5M-2635-N.....	50
5-7-2. Output voltage monitor and output current monitor	51
5-7-3. Constant-voltage (CV) control with external voltage or resistance.....	52
5-7-4. Constant-current (CC) control with external voltage or resistance.....	53
5-7-5. Output ON/OFF with external contacts	54
5-7-6. Alarm function using external contacts.....	55
5-7-7. Various status signals (CV, CC & ALARM).....	56

5-8. Activating output when turning on power.....	57
5-9. Usage of sequence Function.....	57
6. OTHER FUNCTIONS	59
6-1. Display in alarm status	59
6-2. One-Control Parallel Operation (excluding PSF-400L2).....	60
6-3. One-Control series operation (excluding PSF-400L2).....	62
6-4. Power Extension using PSF-800LS (Parallel Connection Only)	63
6-4-1. How to use the PSF-800LS.....	64
6-4-2. Master-slave connection using optional kits	65
7. OPTION.....	68
7-1. Accessories.....	68
7-2. Interface Boards.....	68
8. EXTERNAL CONTROL THROUGH INTERFACE BOARD	69
8-1. Remote Control	69
8-2. Interface connectors.....	69
8-3. Specifications	70
8-3-1. Specifications of IF-60RU	70
8-3-2. Specifications of IF-60GP	71
8-4. Connection Methods	72
8-5. Connection cables.....	73
8-6. Address Setting.....	73
8-7. Using Interface Boards.....	75
8-7-1. Using the GP-IB interface	75
8-7-2. Using the USB interface.....	76
8-7-3. Using the RS-232C interface	76
8-7-4. Using the local bus.....	77
8-8. Communication commands.....	77
8-8-1. Output voltage setting (: VOLT).....	79
8-8-2. OVP setting (: VOLT: PROT).....	79
8-8-3. Output current setting (: CURR)	80
8-8-4. OCP setting (: CURR: PROT)	81
8-8-5. Output power setting (: POW)	82
8-8-6. OUTPUT ON/OFF (: OUTP).....	83
8-8-7. Hi- Ω ON/OFF (: CONF: HIZ)	83
8-8-8. Hi- Ω time setting (: CONF: HIZ: HOLD).....	84
8-8-9. Display switching (: CONF: DISP)	84
8-8-10. Tracking ON/OFF (: CONF: TRAC).....	85
8-8-11. External control setting (: EXT: MOD)	85
8-8-12. External output voltage control ON/OFF (: EXT: VOLT).....	86
8-8-13. External output current control ON/OFF (: EXT: CURR)	86
8-8-14. Output switching (: EXT: OUTP).....	87
8-8-15. Off timer ON/OFF (: TIMER: MOD)	87
8-8-16. Off timer value setting (: TIMER: SET)	88
8-8-17. Delay function ON/OFF (: DELAY: MOD).....	88
8-8-18. Delay rise time setting (: DELAY: RISE).....	89
8-8-19. Delay fall time setting (: DELAY: FALL).....	89
8-8-20. Monitor inquiry (: MEAS?)	89

8-8-21. Preset calling (:PRES:CALL).....	90
8-8-22. Preset saving (:PRES:SAVE).....	90
8-8-23. Sequence mode setting (:SEQ:MOD).....	91
8-8-24. Sequence jump setting (:SEQ:STEP).....	91
8-8-25. Sequence start step setting (:SEQ:START).....	91
8-8-26. Sequencer end step setting (:SEQ:END).....	92
8-8-27. Sequence repetition frequency setting (:SEQ:CYCL).....	92
8-8-28. Sequence data transfer (:SEQ:DOWNLOAD).....	92
8-8-29. Model inquiry (*IDN?).....	93
8-8-30. Event register inquiry (*ESR?).....	93
8-8-31. Event enable register setting (*ESE).....	93
8-8-32. Status byte inquiry (*STB?).....	93
8-8-33. SRQ enable register setting (*SRE).....	93
8-8-34. Buffer clear (*CLS).....	93
8-8-35. Communication reset (*RST).....	94
8-8-36. Command completion (*OPC).....	94
8-8-37. Wait for completion (*WAI).....	94
8-8-38. Local address setting (:ADDR).....	95
8-8-39. Remote/local setting (:REMOTE).....	95
8-9. Registers.....	96
8-9-1. Status register (STB, SRE).....	97
8-9-2. Event register (ESR, ESE).....	98
8-9-3. function of the status byte.....	99
8-9-4. Reading data from the status byte and clearing the status byte.....	100
8-9-5. Clear and reset statuses.....	101
8-9-6. Remote/local function.....	102
8-9-7. Responses to multi-line message commands.....	103
9. TROUBLESHOOTING.....	104
10. MAINTENANCE.....	105
11. OUTSIDE DIMENSIONS.....	107
12. Specification of PSF-1200L/1600L.....	109

USING THE PRODUCT SAFELY

■ Preface

To use the product safely, read this user's guide to the end. Before using this product, understand how to correctly use it.



If you read this manual but you do not understand how to use it, call the company or each sales office that is indicated on the back cover of this user's guide. After you read this manual, save it so that you can read it anytime as required.

■ Notes on reading this user's guide

The contents of this user's guide include technical terms in part of their explanation. If you do not understand those terms, do not hesitate to ask the company or each sales office.

■ Pictorial indication and warning character indication

This user's guide and product show the warning and caution items required to safely use the product. The following pictorial indication and warning character indication are provided.

<p><Pictorial indication></p> 	<p>Some part of this product or the user's guide may show this pictorial indication. In this case, if the product is incorrectly used in that part, a serious danger may be brought about on the user's body or the product. To use the part with this pictorial indication, be sure to refer to this user's guide.</p>
<p><Warning character Indication></p>  <p>WARNING</p>  <p>CAUTION</p>	<p>If you use the product, ignoring this indication, you may get killed or seriously injured. This indication shows that the warning item to avoid the danger is provided.</p> <p>If you incorrectly use the product, ignoring this indication, you may get slightly injured or the product may be damaged. This indication shows that the caution item to avoid the danger is provided.</p>

USING THE PRODUCT SAFELY



WARNING

■ Do not remove the product's covers and panels

Never remove the product's covers and panels for any purpose. Otherwise, the user's electric shock or a fire may be incurred.

■ Warning on using the product

The warning items given below are to avoid danger to the user's body and life and avoid the damage and deterioration of the product. Use the product, observing the following warning and caution items.

■ Warning items on power supply

● Power supply voltage

This product is applicable to the rated source voltage from AC100V to 240V without the need of switching. However, the product is supplied with a AC125V rated power cable, which need be replaced with a proper AC power cable when using the product on source voltage over AC125V. Using the product on such high voltage without replacing the power cable may result in electric shock or a fire.

● Power cord

Important: The attached power cord set can be used for this device only.

If the attached power cord is damaged, stop using it and call the company or each sales office. If the power cord is used without the damage being removed, an electric shock or fire may be caused.

● Protection fuse

If an input protection fuse is blown, the product does not operate. When the fuse is blown, the user can replace it. However, replace it correctly, observing the warning and caution items that are provided in the section of the user's guide where the fuse replacement is explained. If the fuse is incorrectly replaced, a fire may occur.

● Changing the power supply voltage

The rated voltage range of the product is unchangeable. Do not use the product on any voltage over or below the rated voltage range marked on the product, which is from AC100V to 240V. Use the product within this range. (The AC power cable need be replaced with a proper power cable when using the product on source voltage over AC125V.)

USING THE PRODUCT SAFELY



WARNING

■ Warning item on grounding

The product has the GND terminal on the panel surface to protect the user from electric shock and protect the product. Be sure to ground the product to safely use it.

■ Warning item on installation environment

● Operating temperature

Use the product within the operating temperature indicated in the rating column. If the product is used with the vents of the product blocked or in high ambient temperatures, a fire may occur.

● Operating humidity

Use the product within the operating humidity indicated in the rating column. Watch out for condensation by a sharp humidity change such as transfer to a room with a different humidity. Also, do not operate the product with wet hands. Otherwise, an electric shock or fire may occur.

● Use in a gas

Use in and around a place where an inflammable or explosive gas or steam is generated or stored may result in an explosion and fire. Do not operate the product in such an environment.

Also, use in and around a place where a corrosive gas is generated or spreading causes a serious damage to the product. Do not use the product in such an environment.

● Do not let foreign matter in

Do not insert metal and flammable materials into the product from its vent and spill water on it. Otherwise, an electric shock and fire may occur.

■ Warning item on abnormality while in use

If smoke or fire is generated from the product while in use, stop using the product, turn off the switch, and remove the power cord plug from the outlet. After confirming that no other devices catch fire, call the company or each sales office.

USING THE PRODUCT SAFELY



CAUTION

■ **Input/output terminal**

Maximum input to the input terminals is specified to prevent the product from being damaged. Do not supply input, exceeding the specifications that are indicated in the "Rating" or "Caution on use" column in the user's guide of the product. Otherwise, a product failure is caused. Also, do not supply power to the output terminals from the outside. Otherwise, a product failure is caused.

■ **When the product is left unused for a long time**

Be sure to remove the power plug from the outlet.

(Calibration)

Although the performance and specifications of the product are checked under strict quality control during shipment from the factory, they may slightly change because of secular changes in its parts. It is recommended to periodically calibrate the product so that it is used with its performance and specifications stable. For consultation about the product calibration, call the dealer or the company or each sales office where you bought the product.

(Daily maintenance)

When you clean off the dirt of the product covers, panels, and knobs, avoid solvents such as thinner and benzene. Otherwise, paint may peel off or the resin surface may be affected.

To wipe off the covers, panels, and knobs, use a soft cloth with neutral detergent in it. During cleaning, be careful that water, detergents, and other foreign matters do not get into the product.

If a liquid or metal gets into the product, an electric shock and fire are caused. During cleaning, remove the power cord plug from the outlet.

Use the product correctly and safely, observing the above warning and caution items. Because the user's guide indicates caution items even in individual items, observe those caution items to correctly use the product.

If you have questions or comments about the content of the user's guide, call the company's sales office.

1. GENERAL

1-1. General

The PSF Series is a variable output type high-performance switching DC stabilized power supply unit. It incorporates a high-frequency current suppression circuit and is applicable to the rated source voltage from AC100V to 240V without the need of switching. It offers wide-range voltage and current outputs within the maximum rated power range. It also has a variable constant power function. It has such standard features as voltage and current setting, output On/Off, monitor output and other functions through external connectors. The frame depth is smaller than the traditional models for saving the installation space and providing a wider work space. Two-output model and current extension model are newly released for wider range of applications. The PSF Series is able to execute sequence programs, which are written in it using the optional interface board in advance, without anything else. It is possible to control the PSF Series from a Personal computer through the optional GP-IB, RS-232C or USB interface board.

The application software exclusive for the PSF series may be downloaded from our homepage.

Homepage address – <http://www.texio.co.jp>

1-2. Applicable Products

Product name	Voltage range	Current range	Power range
PSF-400L	0V to 80V	0A to 40A	10W to 400W
PSF-800L	0V to 80V	0A to 80A	10W to 800W
PSF-400L2 (Two-output type)	0V to 80V x2CH	0A to 40A x2CH	10W to 400W x2CH
PSF-800LS (Current extension)	0V to 80V	0A to 80A	10W to 800W
PSF-1200L (400L+800LS)	0V-80V	0A-120A	30W-1200W
PSF-1600L (800L+800LS)	0V-80V	0A-160A	20W-1600W
IF-60GP (GP-IB)	Optional GP-IB interface board		
IF-60RU (RS-232C, USB)	Optional RS-232C and USB interface board		

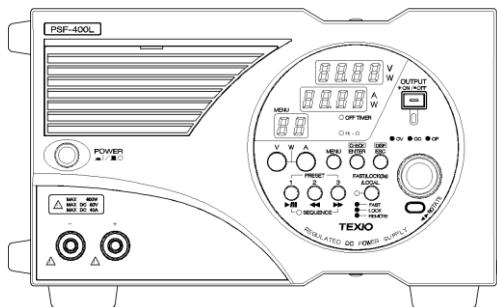

■ 400W Type
PSF-400L

■ 800W Type
PSF-800L

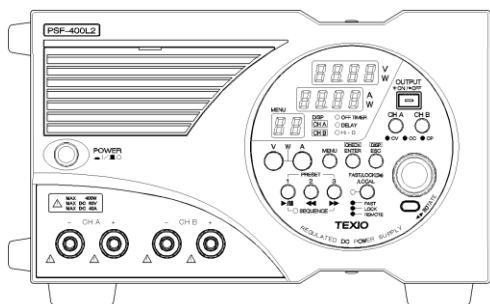

■ 400Wx2-Channel Type
PSF-400L2

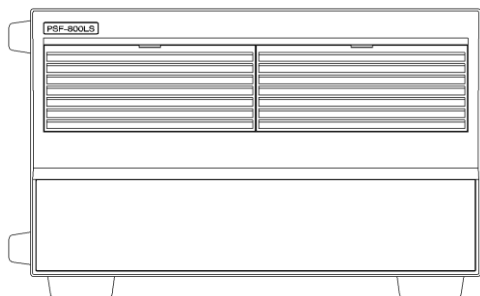

■ 800W Type
(For Current Extension)
PSF-800LS

1-3. Features

- **Flexible range Output**
Capable of wide-range voltage and current setting within the rated power range to cover the ranges of four models of our existing PS power supply units.
- **Constant-Power Control**
Newly provides constant-power (CP) control in addition to constant-voltage (CV) and constant-current (CC) controls.
- **Power Factor Correction Circuit**
A built-in power factor correction circuit ensures compatibility to a wide AC input voltage range from AC100V to 240V without the need of switching. It also suppresses harmonic current.
- **Two-Output Model (PSF-400L2)**
Equipped with two 400W output channels for a wide variety of applications.
- **Rotary Panel Operation Unit**
The panel operation unit may be rotated by 90 degrees for easy-to-see monitoring in either horizontal or vertical installation.
- **Off Timer Function**
Turns off output automatically after a lapse of preset time in order to prevent “a failure to turn off output” or “over-charging” even in the case where the user does any other work without turning it off.
- **Sequence (SEQ) Function**
Executes data read from a Personal computer through the optional interface board on the panel operation unit. Two operation modes are available: Manual mode (for execution while checking the step details), and automatic mode (for automatic execution of steps). (99 steps, 999 cycles)
- **Delay (DLY) Function: PSF-400L2 Only**
Capable of setting the time of changing the output actually after turning it on (or off) between the channels A and B.
- **Tracking Function: PSF-400L2 Only**
The set value of the channel B is made equal to that of the channel A when the tracking function is activated. Hereafter, both channels change synchronously.
- **Protective Functions**
Has internally fixed protective functions, which are OVP, OCP and OHP. Also has OVP and OCP functions, which may be set on the panel operation unit.
- **Preset Functions (Three Points)**
Pressing a preset key directly selects a preset value, which is set in advance.

- **One Control Operation**
Provides master-slave one control operations. In parallel operation, a maximum of four extension units, including the master unit, may be used to increase power. In series operation, a maximum of two extension units, including the master unit, may be used.
- **External Control Function**
Offers voltage- and resistance-based controls, voltage monitoring, current monitoring, output On/Off, alarm, CV/CC status and other functions as the standard features.
- **Options**
Two types of optional boards, GP-IB + local bus board and RS-232C + USB + local bus board, are available for applications with several built-in units, which are operated simultaneously in a factory, etc.
It is possible to store sequence programs and read voltage and current data if application software is created.
- **Space Saving Design**
The frame depth is shorter than our other products for easy installation on a desk or other small space.

1-4. Accessories

The PSF power supply unit is supplied with the following accessories:

- (1) CD-ROM(Instruction manual)
- (2) Screws for output terminals on rear panel
- (3) Protection covers for output terminals on rear panel
- (4) Protection caps for output terminals on front panel
- (5) External control connector (26-pin)
- (6) GND cable
- (7) AC power cable

2. SPECIFICATIONS

Output Specifications

Model	PSF-400L	PSF-800L	PSF-400L2	PSF-800LS
Rated output voltage	80.00V	80.00V	80.00V x2CH	80.00V
Setting accuracy	0.1%setting±2digit (23°C±5°C)			/
Resolution	10mV			
Display accuracy	0.2%reading±2digit (23°C±5°C)			
Rated output current ※1	40.00A	80.00A	40.00A x2CH	80.00A
Setting accuracy	0.2%setting±2digit (23°C±5°C)			/
Resolution	10mA			
Display accuracy	0.3%reading±2digit (23°C±5°C)			
Rated output power ※2	400W	800W	400W x2CH	800W
Setting accuracy	±10W			/
Resolution	10W			
Display accuracy	0.5%reading±5digit (23°C±5°C)			

NOTES

※1: The maximum output current through the front output terminals is 40A.

※2: Switching from the constant-voltage (CV) or constant-current (CC) mode into the constant-power (CP) mode or vice versa is subject to over-shoot ringing, etc.

Input Specifications

Model	PSF-400L	PSF-800L	PSF-400L2	PSF-800LS
Input voltage	AC100V to 240V, single-phase, frequency: 50Hz or 60Hz			
Power consumption ※3	560VA	1120VA	1120VA	1120VA
Power factor ※4	0.99			
Rush current	35Amax.	70Amax.	70Amax.	70Amax.

NOTES

※3, 4: At the rated output voltage and AC100V input

Constant-Voltage Characteristics

	PSF-400L	PSF-800L	PSF-400L2
Source fluctuation ※5	0.01% ±2mV of rated voltage		
Load fluctuation ※6	0.01% ±3mV of rated voltage		
Ripple noise (p-p) ※7	90mV	150mV	90mV
Ripple noise (rms) ※8	4mV	6mV	4mV
Transient response (typ.) ※9	1ms	1ms	1ms
Rise time (typ.) ※10	50ms (rated load), 50ms (no load)		
Fall time (typ.) ※11	100ms (rated load), 500ms (no load)		
Temperature coefficient (typ.) ※12	±50ppm/°C (after 30-minute warming up)		

Constant-Current Characteristics

	PSF-400L	PSF-800L	PSF-400L2
Source fluctuation ※5	0.01% ±2mA of rated current		
Load fluctuation ※13	0.02% ±3mA of rated current		
Ripple noise (rms)	30mA	60mA	30mA
Temperature coefficient (typ.) ※12	±100ppm/°C (after 30-minute warming up)		

Constant-Power Characteristics

	PSF-400L	PSF-800L	PSF-400L2
Source fluctuation ※5	0.5%±10W		

NOTES

- ※5: Fluctuation when the source voltage is changed by ±10% in the range from AC100V to 240V.
- ※6: Fluctuation when the load is changed from the rated load into no load (open circuit) at the rated output voltage.
- ※7: Measured at the frequency up to 20 MHz.
- ※8: Measured at the frequency up to 1 MHz.
- ※9: Response time till the output voltage is restored to the range within 0.1% + 10 mV of the rated output voltage when the output current is changed from 50% to 100% of the maximum output current at the rated output voltage.
- ※10: Value with a fixed load.
Time until the output voltage increases up to 10% to 90% of the rated output voltage.
- ※11: Value with a fixed load.
Time until the output voltage decreases down to 90% to 10% of the rated output voltage.
- ※12: Value after 30 minutes of warming up (excluding external control).
- ※13: Fluctuation when the load is changed from the rated load into no load (short circuit) at the rated output current.

Functions

Constant-voltage (CV) control with external voltage	Output voltage: Approx. 0V to 80V for external voltage: 0V to 10V
Constant-voltage (CC) control with external resistance	Output voltage: Approx. 0V to 80V for external resistance: 0Ω to 10kΩ
Constant-current (CC) control with external voltage	Output current: Approx. 0A to 40A (400L & 400L2) or 0A to 80A (800L) for external voltage: 0V to 10V
Constant-current (CC) control with external resistance	Output current: Approx. 0A to 40A (400L & 400L2) or 0A to 80A (800L) for external resistance: 0Ω to 10kΩ
External On/Off control	On/Off at contact, short: On, open: Off
Output voltage monitor signal	Approx. 0V to 10V for 0V to rated output voltage.
Output current monitor signal	Approx. 0V to 10V for 0V to rated output current.
Constant-voltage (CV) status signal	Open collector, active Low.
Constant-current (CC) status signal	Open collector, active Low.
Alarm signal output	Open collector, active Low.
Alarm signal input	Turns off output when shorted.
Remote sensing function	Compensates for voltage drop up to 1V (single side). Within rated voltage at both ends of power supply.
Parallel one-control operation	Up to four units (excluding 400L2).
Series one-control operation	Up to two units (excluding 400L2).
Preset function	A maximum of three points are presettable.
Off timer (OFF TIMER) function	Time until turning off output is presettable. Setting range: 10min. to 99hrs. & 50min.
High-impedance (Hi-Ω) function	Turns off internal bleeder circuit. Holding Time: 5min to 30min
Delay (DELAY) function	Output delay time is presettable. Setting range: -9.99sec to 10.00sec. (Resolution: 0.01sec.)
Tracking function ※14	May change setting of two channels simultaneously.
Key lock function	Disables operations on front panel.
Sequence function	Number of steps: 0 to 99 Step time: 1 to 9999 (sec.) Number of cycles: 1 to 999 (--: Infinite) The product is capable of simple program operations using the exclusive application software. The application software exclusive for sequence operation may be downloaded from our homepage.

NOTE

※14: Available on the PSF-400L2 only.

Protective functions

Over-voltage protection (OVP): Fixed ※15	Output Off when output voltage exceeds 110% of rated voltage.
Over-voltage protection (OVP): Variable ※16	Presettable in range from 1V to 84V on front panel. Output Off when OVP works.
Over-current protection (OCP): Fixed ※15	Output Off when output current exceeds 110% of rated current.
Over-current protection (OCP): Variable ※16	Presettable in range from 1A to 42A on front panel. Output Off when OCP works. (800L:84A)
Overheat protection (OHP) ※15	Output Off at the internal heat sink temperature over the set temperature.

NOTES

※15: Throw the POWER switch again to reset.

※16: Throw the POWER switch again or press the ESC key to reset.

Environmental Conditions

Operating temperature range	0°C to +40°C
Operating humidity range	30% RH to 80% RH (No dew condensation)
Storage temperature range	-20°C to +70°C
Storage humidity range	30% RH to 80% RH (No dew condensation)

Applicable Standards

LVD		EN61010-1 3rd edition (2010) Indoor use Altitude up to 2000m Transient overvoltage: Overvoltage category II Pollution Degree 2 EN61000-3-2 clause 7.1 class A EN61000-3-3 clause 5.
EMC	EMS (Min)	EN61326-1: 2013
	EMI (Class A)	EN61326-1: 2013

※ The standards are applicable for the product marked CE on the rear panel only and not for the modified product.

The PSF-1200L / 1600L and the master slave mode does not apply.

Others

Cooling method	Forced cooling with fan motor
To-GND voltage	±DC500V
Dielectric strength voltage	Power In terminals - frame: AC1500V, 1min. Power In terminals - output terminals: DC3200V, 1min.
Insulation resistance	Power In terminals - frame: DC500V, 30MΩ or more Power In terminals - output terminals: DC500V, 30MΩ or more Output terminals - frame: DC500V, 30MΩ or more
Outside dimensions (Projections not included.)	210mm(W) × 124mm(H) × 290mm(D)
Weight	PSF-400L: Approx. 5kg PSF-800L, 400L2 & 800LS: Approx. 7kg

■ One-Control Operation Setting Table

400L

Item		Single	Parallel connection						Series connection
		400L	400L × 2	400L × 3 400L+800L	400L × 4	400L+800L × 2	400L+400L+ 800L × 2	400L+800L × 3	400L+400L
		400W	800W	1200W	1600W	2000W	2400W	2800W	800W
Voltage setting	SLOW	10mV							
	FAST	1V							
	Range	0V-82V							
	Min. display digit	10mV							
Current setting	SLOW	10mA	100mA	90mA	80mA	100mA	60mA	70mA	10mA
	FAST	1A	10A	9A	8A	10A	6A	7A	1A
	Range	0A-41A	0A-82A	0A-123A	0A-164A	0A-205A	0A-246A	0A-287A	0A-41A
	Min. display digit	10mA	100mA						10mA
Power setting	SLOW	10W	100W	99W	100W	100W	96W	98W	10W
	FAST	100W	1000W	990W	1000W	1000W	960W	980W	100W
	Range	10W-410W	20W-820W	30W-1230W	40W-1640W	50W-2050W	60W-2460W	70W-2870W	10W-410W
	Min. display digit	1W							
OVP setting	SLOW	100mV							
	FAST	10V							
	Range	1V-84V							
	Min. display digit	10mV							
OCP setting	SLOW	100mA	200mA	300mA	400mA	500mA	600mA	700mA	100mA
	FAST	10A	20A	30A	40A	50A	60A	70A	10A
	Range	1A-42A	2A-84A	3A-126A	4A-168A	5A-210A	6A-252A	7A-294A	1A-42A
	Min. display digit	10mA	100mA						10mA

Rating of PSF-1200L, please refer to Chapter 12.

800L

Item		Single	parallel connection			Series connection
		800L	800L × 2	800L × 3	800L × 4	800L+800L
		800W	1600W	2400W	3200W	1600W
Voltage setting	SLOW	10mV				
	FAST	1V				
	Range	0V-82V				
	Min. display digit	10mV				
Current setting	SLOW	10mA	100mA	90mA	80mA	10mA
	FAST	1A	10A	9A	8A	1A
	Range	0A-82A	0A-164A	0A-246A	0A-328A	0A-82A
	Min. display digit	10mA	100mA			10mA
Power setting	SLOW	10W	100W	99W	100W	10W
	FAST	100W	1000W	990W	1000W	100W
	Range	10W-820W	20W-1640W	30W-2460W	40W-3280W	10W-820W
	Min. display digit	1W				
OVP setting	SLOW	100mV				
	FAST	10V				
	Range	1V-84V				
	Min. display digit	10mV				
OCP setting	SLOW	100mA	200mA	300mA	400mA	100mA
	FAST	10A	20A	30A	40A	10A
	Range	1A-84A	2A-168A	3A-252A	4A-336A	1A-84A
	Min. display digit	10mA	100mA			10mA

In series connection, the output voltage is twice as high as that of the master unit.

In parallel connection, the minimum digit of current display is 100mA.

In some model combinations, the resolution of current setting is different from the minimum digit of current display and the display may not be changed by clicking the mouse button once.

Rating of PSF-1600L, please refer to Chapter 12.

■ Default Setting and Storage after Power Off

Default Setting List of PSF Series

Item	Initial setting	Storage after power off
Voltage	0.00V	○
Current	0.00A	○
Power	410W/820W	○
OVP	84.00V	○
OCP	42.00A/84.00A	○
Display mode	CHA(V/A)	○
Menu display	Initialized when power is turned off.	×
Operation mode	V	○
External voltage control	OFF	○
External resistance control	OFF	○
External output on/off	IN	○
Preset function	OFF	○
Preset item: Voltage	0V	○
Preset item: Current	0A	○
Preset item: Power	410W/820W	○
Off-timer function	OFF	○
High-impedance function	OFF	○
High-impedance holding time	30min	○
Delay function	OFF	○
Trailing delay time	0	○
Falling delay time	0	○
Tracking function	OFF	○
Sequence function	OFF	○
Sequence start No.	0	○
Sequence end No.	99	○
Sequence repetition frequency	1	○
Sequence item: Voltage	0V	○
Sequence item: Current	41.00A/82.00A	○
Sequence item: Power	410W/820W	○
Sequence item: Output	OFF	○
Sequence item: Time	1sec	○
Key lock function	OFF	×
One-control operation	OFF	○
Output status	Initialized when power is turned off.	×
Sequence operation status	× (Stop status)	×
Off-timer operation status	× (Non operating status)	×
System address	1	○
Personal computer address	3	○

3. PRELIMINARY INSTRUCTIONS

Be sure to read through this section before using the PSF Series power supply unit.



WARNING

- **Checking the Source Voltage**
Use the PSF Series power supply unit within the rated source voltage range, which is AC100V to 240V (allowance: $\pm 10\%$), single-phase, 50Hz or 60Hz.
- **Connecting the AC Power Cable**
Be sure to use the AC power cable supplied with the product.



CAUTION

- **AC Power Cable**
Attached AC cable is different according to the destination. Make sure the rating of the AC cable.
- **Grounding**
Be sure to ground the PSF Series power supply unit to prevent electric shock or electrocution.
A failure of grounding the unit may result in malfunctioning due to external noises and/or increased noises generated by the unit.
Be sure to connect the GND terminal if a 2P-3P conversion plug is used owing to unavoidable circumstances.
- **Instructions on Using the PSF Series in the Floating Condition**
Using the PSF Series power supply unit in the floating condition is subject to high potential between the frame and output terminals.
If the frame and output terminals are short-circuited in this condition, a measuring instrument or load connected with the PSF Series may be broken. Be very careful. Such high potential may remain in the noise reduction capacitor after use. Never short-circuit the terminal or touch them by hand. Disobedience to this instruction may cause electric shock or electrocution.



CAUTION

- **Instruction on Using the Output Terminals**

The PSF Series is a floating type power supply unit. Connect either output terminal on the rear panel with the GND terminal of the frame, if output should be grounded. The output terminals on the front panel are auxiliary output terminals, whose maximum current is 40A. Note that using the front output terminals may not satisfy the electrical specifications.

Do not use the front and rear output terminals simultaneously. Using them together may result in troubles.

- **Instruction on Turning On Power**

When the PSF Series power supply unit is turned on, the version data of the internal ROM are displayed, the model name, presence or absence of the interface, address and other data are displayed, and then the set voltage and current are displayed.

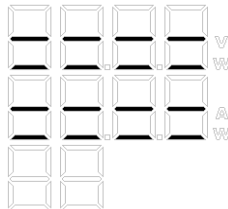

Display while storing the set values

- **Precaution for turning off power**

The PSF Series power supply unit stores set values immediately before the source voltage is shut off or the POWER switch is turned off. These stored values serve as the initial values when it is turned on next time.

- Once power is turned on or off, the user should wait for five seconds or more before turning it off or on. If power is turned on and off repeatedly at intervals of five seconds or less, the unit may fail to store the set values, the power fuse may be deteriorated due to a fault of the rush current limit circuit, or the POWER switch may become defective.

4. DEVICES ON PANELS

4-1. Front Panel

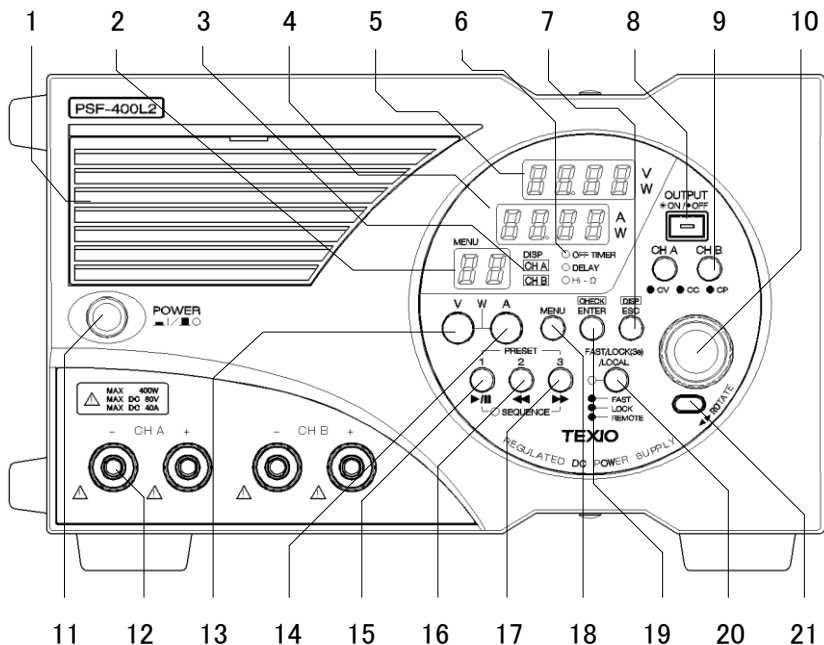

Fig.4-1 Front Panel(PSF-400L2)

1. Front grill

This is a ventilation grill for taking air for cooling the internal circuits into the unit. It is detachable and has a dust filter inside. Clean the filter periodically.

2. Address No., number of steps, number of cycles, and menu No.

Normal operation	Sequence operation	Menu	Tracking
Not displayed.	Number of steps is displayed.	Menu No. is displayed.	"Ab" is displayed.

3. Channel LEDs

The LED of a selected channel is lit. Both LEDs are lit when the tracking function is activated.

4. Current 7-segment LED

Normal operation	Sequence operation	Menu	Alarm
Current or power is displayed.	Step No. is displayed.	Set item is displayed.	OVP, OCP, HARD or OHP is displayed.

The “W” LED on the right of the 7-segment LED is lit in the power display state.

5. Voltage 7-segment LED

Normal operation	Sequence operation	Menu	Alarm
Voltage or power is displayed.	Cycle No. is displayed.	Set parameter is displayed.	OVP, OCP, HARD or OHP is displayed.

The “W” LED on the right of the 7-segment LED is lit in the power display state.

6. Function LEDs

These LEDs display the On/Off state the functions.

The (green) LED is lit when the corresponding function is activated.

◆ See Fig.4-2 Panel Operation Unit below.

7. ESC/DISP key (**ESC** / **DISP**)

Changes the channel display, sequence operation display (i.e., step No. and cycle No.), remaining time in off-timer operation and other displays.

When the menu is displayed, pressing it exits the function selection mode and returns to the normal mode.

8. OUTPUT key (red) (**OUTPUT**)

This key turns on or off output.

The LED is lit when output is turned on.

9. CHA and CHB keys (red, green, orange) (**CHA**, **CHB**)

These keys turn on or off the channel outputs. When the output is on, the LED of the color representing the output mode is lit.

The green LED is lit in the constant-voltage (CV) mode, the red LED in the constant-current (CC) mode, and the orange LED in the constant-power (CP) mode.

These keys are provided on the PSF-400L2 only.

The PSF-400L and PSF-800L have LEDs only.

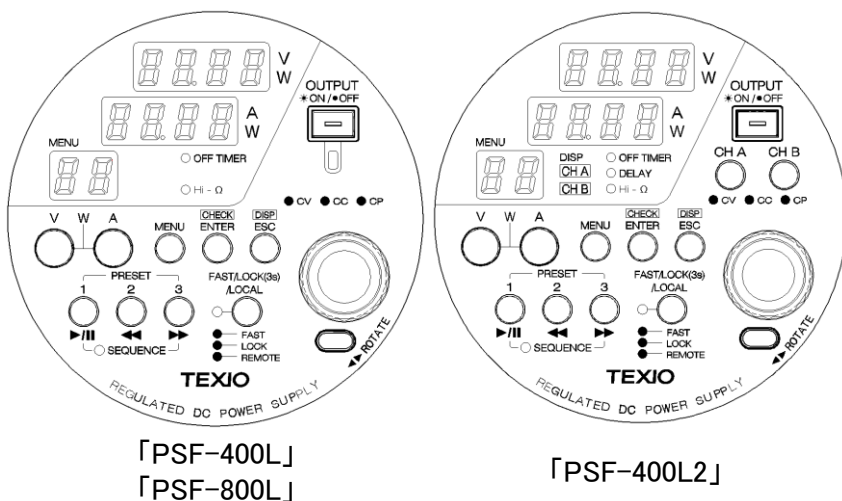









Fig.4-2 Panel Operation Unit

10. Rotary encoder (hereinafter merely referred to as encoder)
Used to select the functions and change the values.
11. POWER ON/OFF switch
Press the switch to the (I) position to turn on the power supply unit.
Press it again to turn off the unit (the switch returns to the Out position).
12. Front output terminals
Output is supplied through these terminals.
The maximum current is 40A.
13. V key (green) ()
Used for voltage setting. Press the key and rotate the encoder to change the set value. If the  key is pressed while holding the  key, both LEDs are lit and the current 7-segment LED enters the power display mode.
14. A key (green) ()
Used for current setting. Press the key and rotate the encoder to change the set value. If the  key is pressed while holding the  key, both LEDs are lit and the voltage 7-segment LED enters the power display mode.
15. PRESET 1 key (green) ()
Reads out data stored in PRESET 1.
Serves as a start/pause key () in the sequence mode.

16. PRESET 2 key (green) (**PRESET 2**)
 Reads out data stored in PRESET 2.
 Serves as a jump key (**◀**) to a number one smaller than the step number in the sequence mode.
17. PRESET 3 key (green) (**PRESET 3**)
 Reads out data stored in PRESET 3.
 Serves as a jump key (**▶**) to a number one larger than the step number in the sequence mode.
18. MENU key (**MENU**)
 Used for setting and selection of various functions.
19. ENTER/CHECK key (**ENTER** / **CHECK**)
 Alternates the output value and set value.
 When the output is on, every press of the **ENTER** / **CHECK** key alternates output value display and set value display.
- When the **V** key is lit → Voltage setting is enabled.
 - When the **A** key is lit → Current setting is enabled.
 - When the **V** and **A** keys are lit → Power setting is enabled.
- When the menu is displayed, press this key to validate functions and values.
20. FAST/LOCK (3s)/LOCAL change-over key (**FAST**)
 Changes the digit of the voltage, current or power set value, locks panel operation, or changes the remote mode into the local mode. The LED color depends on the status.
- FAST (green) : The setting resolution is 1V, 1A or 100W.
 LOCK (3s) (red) : Operations on the front panel are disabled.
 REMOTE (orange) : Lit during communication through the optional board.
21. ROTATE key
 The panel operation unit of the PSF Series may be rotated by 90 degrees to ensure easy operation in either horizontal or vertical installation.
 Hold the encoder and rotate the panel operation unit while pressing the key.

4-2. Rear Panel

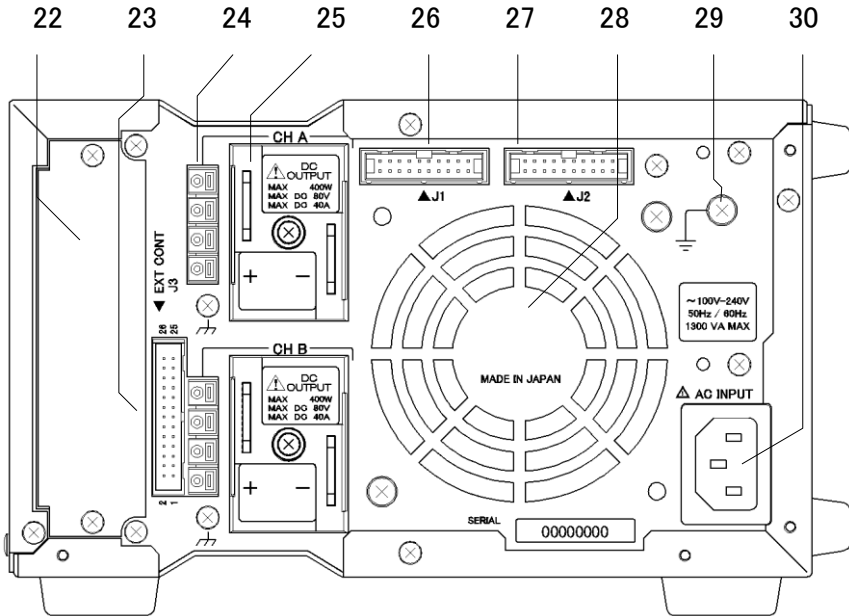

Fig.4-3 Rear Panel (PSF-400L2)

22. Optional board slot

Used to install the optional IF60-GP or IF60-RU board for controls through the interface.

The product is supplied with slot covered with a blank panel.

23. J3 external control connector

Used for various controls.

◆ See section “5-7. External Control Functions” below.

Pin assignment of this connector is as shown below.

Pin No.	Signal name	Function
1	CHB STATUS COM (COM of 2, 3 & 4)	COM of pins 2, 3 and 4.
2	CHB ALARM OUT	Open collector output. Set to the L level when the channel B is in the alarm mode.
3	CHB EXT CC STATUS OUT	Open collector output. Set to the L level when the channel B is in the CC mode.
4	CHB EXT CV STATUS OUT	Open collector output. Set to the L level when the channel B is in the CV mode.
5	CHB EXT CV CONTROL IN	Constant-voltage control input pin of the channel B. Control from approx. 0 to the rated output voltage at 0V to 10V in the external voltage control mode. Control from approx. 0 to the rated output voltage at 0k Ω to 10k Ω in the external resistance control mode.
6	CHB EXT CC CONTROL IN	Constant-current control input pin of the channel B. Control from approx. 0 to the rated output current at 0V to 10V in the external voltage control mode. Control from approx. 0 to the rated output current at 0k Ω to 10 k Ω in the external resistance control mode.
7	CHB COM	COM pin of the channel B. Connected with the negative output terminal of the channel B.
8	CHB EXT V MON OUT	Output voltage monitor pin of the channel B. Outputs approx. 0V to 10V for 0 to the rated output voltage.
9	CHB EXT A MON OUT	Output current monitor pin of the channel B. Outputs approx. 0V to 10V for 0 to the rated output current.
10	CHB COM	COM pin of the channel B. The negative output terminal of the channel B.
11	CHB EXT ALARM IN	Causes the alarm status when short-circuited with the CHB COM pin.
12	CHB EXT OUTPUT IN	Turns on output when short-circuited with the CHB COM pin.
13	CHB COM	COM pin of the channel B. Connected with the negative output terminal of the channel B.
14	CHA EXT CV CONTROL IN	Constant-voltage control input pin of the channel A. Control from approx. 0 to the rated output voltage at 0V to 10V in the external voltage control mode. Control from approx. 0 to the rated output voltage at 0k Ω to 10k Ω in the external resistance control mode.

Pin No.	Signal name	Function
15	CHA EXT CC CONTROL IN	Constant-current control input pin of the channel A. Control from approx. 0 to the rated output current at 0V to 10V in the external voltage control mode. Control from approx. 0 to the rated output current at 0k Ω to 10k Ω in the external resistance control mode.
16	CHA COM	COM pin of the channel A. Connected with the negative output terminal of the channel A.
17	CHA EXT V MON OUT	Output voltage monitor pin of the channel A. Outputs approx. 0V to 10V for 0 to the rated output voltage.
18	CHA EXT A MON OUT	Output current monitor pin of the channel A. Outputs approx. 0V to 10V for 0 to the rated output current.
19	CHA COM	COM pin of the channel A. Connected with the negative output terminal of the channel A.
20	CHA EXT ALARM IN	Causes the alarm status when short-circuited with the CHA COM pin.
21	CHA EXT OUTPUT IN	Turns on output when short-circuited with the CHA COM pin.
22	CHA COM	COM pin of the channel A. Connected with the negative output terminal of the channel A.
23	CHA EXT CV STATUS OUT	Open collector output. Set to the L level when the channel A is in the CV mode.
24	CHA EXT CC STATUS OUT	Open collector output. Set to the L level when the channel A is in the CC mode.
25	CHA ALARM OUT	Open collector output. Set to the L level when the channel A is in the alarm mode.
26	CHA STATUS COM (COM of 23, 24 & 25)	COM of pins 23, 24 and 25.

Pins 1 to 13 are not used on the PSF-400L and PSF-800L.

24. Sensing terminals

Used to change the sensing point. Short-circuited before shipment to select the internal sensing.

◆ See section “5-6. Output Voltage Remote Sensing” below.

25. Rear output terminals

Power of the PSF Series power supply unit is output through these terminals. The channel A terminal block is in the upper position (CHA) and the channel B terminal block is in the lower position (CHB) when the unit is viewed from the back. On each terminal block, the positive (+) terminal is on the left and the negative (–) terminal is on the right when the unit is viewed from the back. Connect either output terminal with the screw with the  mark near the terminal block if it need be grounded with the frame.

26. J1 control signal input connector
This connector is provided for one-control operation.
Use the optional one-control operation cable.
◆ See sections “6-2. One-Control Parallel Operation” and “6-3. One-Control Series Operation” below.
27. J2 control signal output connector
This connector is provided for one-control operation. Use the optional one-control operation cable.
◆ See sections “6-2. One-Control Parallel Operation” and “6-3. One-Control Series Operation” below.
28. Exhaust grill
Air taken into the unit from the front is blown out through this grill. Leave a 30cm or more space behind the rear panel for good ventilation. If there is some object near the rear panel, the temperature inside the power supply unit may rise excessively.
29.  Functional ground terminal
Grounding the product conductor with this terminal.
30. AC INPUT
Connect the AC power cable supplied with the unit with this plug receptacle and supply commercial power to the unit.

5. OPERATION PROCEDURES

5-1. Connecting AC Power Cable

Make sure that the power source is shut off.
Use the AC power cable supplied with the product.

Plug the connector of the AC power cable into the AC INPUT receptacle on the rear panel.

5-2. Connecting Load with Output Terminals



CAUTION

Be careful of the
temperature!



Be sure to connect the load in the condition where the POWER switch is off.

To connect a load, use cables having large enough current capacity for the rated output and current in order to prevent a fire. The current capacity of the cables should be still higher if the cables are twisted to reduce noises or avoid malfunctioning.

Use cables of the rated voltage over the grounding voltage (500V) for the load.

The front output terminals and rear output terminals are connected internally. Even when the front output terminals are used, the rear output terminals also output voltage. Put the protective covers supplied with the product on the rear output terminals to avoid electrocution.

5-2-1. Connection with the rear output terminals

- (1) Remove AC cable from AC INPUT.
- (2) Connect crimp style lug terminals to the ends of the load cables.
Tighten the lug terminals firmly using the nuts supplied with the product.



CAUTION

The rear output terminals have M6 holes and M3 (tapped) holes. Be sure to use the M6 holes to output power. Noises at the load end may be reduced by twisting the cables to the load or connecting a film capacitor of low high-frequency impedance (several μF) and an electrolytic capacitor (several hundred μF) to the load end.

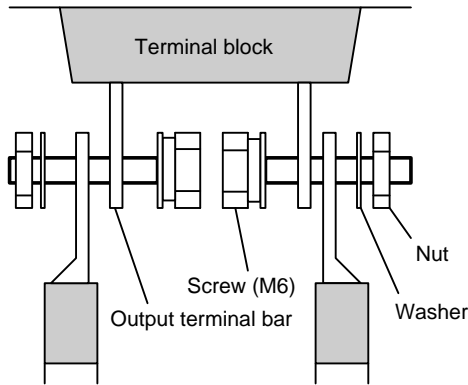

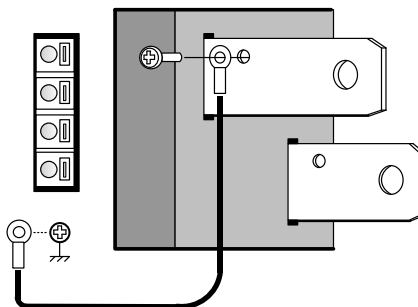

Fig.5-1 Connection with Rear Output Terminals

※ **Connect the cables using the bolts supplied with the product as shown above. If other bolts are used, they may get into contact with the protective cover. The lug terminals must be outside the output terminals.**

(3) Connect positive or negative output terminal with the GND screw with the  mark using the GND cable supplied with the product as the necessity requires.

※ **The negative potential of the external voltage control is the same as that of the negative output terminal. If the power supply unit is grounded at the positive terminal and the power source for external control is grounded at the negative terminal, the load cables for external voltage control short-circuits the output of the power supply unit, resulting in troubles. Use the power source for external voltage control in the floating condition.**



Connect with this screw

Fig.5-2 Positive Grounding Connection

- (4) Sandwich the output terminals and load cables from above and below with the rear output terminal protective covers as shown below. Drive the screw into the protective covers at the center.

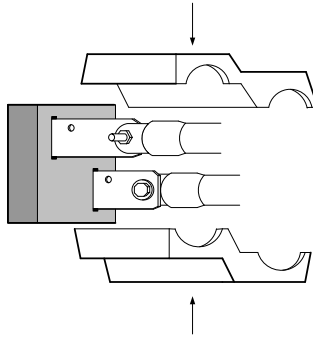

Fig.5-3 Attaching Rear Output Terminal Protective Covers

⚠ CAUTION

Make sure to mount the attached protection cover on the terminal which is not used when using front output terminal or rear output terminal. Front output terminal and rear output terminal are connected internally, and output voltage is charged to non-using terminal. Electric shock may be given to touch the non-covered terminal.

The rear output terminals have M6 holes and M3 (tapped) holes. Be sure to use the M6 holes to output power. Noises at the load end may be reduced by twisting the cables to the load or connecting a film capacitor of low high-frequency impedance (several μF) and an electrolytic capacitor (several hundred μF) to the load end.

- (5) Cut the shaded parts shown below with nippers or the like to connect the PSF series in series or in parallel or to ground the output.

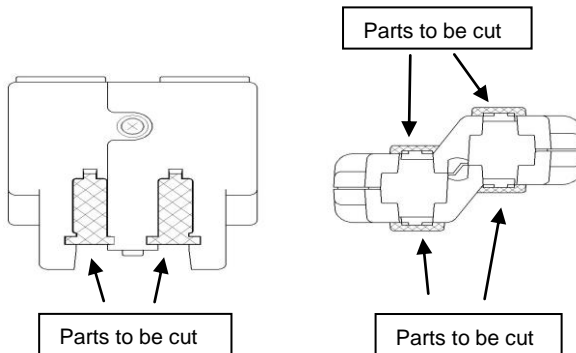

Fig.5-4 Parts to be cut

5-2-2. Connection with the front output terminals

- (1) Shut off the POWER switch.
- (2) Connect crimp style lug terminals to the ends of the load cables.
Fix the load cables firmly to eliminate looseness or backlash from the front output terminals and load cables.
- (3) Protect the front output terminals with the protective caps supplied with the product for safety, if current is output through the rear output terminals.

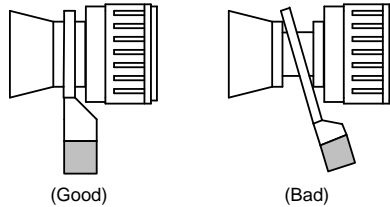

Fig.5-5 Connection with Front Output Terminals



CAUTION

- The power supply unit may output a maximum of 40A through the front output terminals. Do not use pin plugs or banana plugs for outputting large current in order to avoid overheat due to contact resistance. Use lug terminals that meet the output current rating and connect them firmly with the front output terminal.
- For safety, NEVER output power through both the front and rear output terminals.

5-3. Operation Ranges

The PSF Series power supply units offer wider ranges of voltage and current setting within the rated power range than our traditional models.

- Voltage setting range: 0V to 80V (All models)
- Current setting range: 0A to 40A (PSF-400L & PSF-400L2)
0A to 80A (PSF-800L & PSF-800Ls)
- Power setting range: 10W to 400W (PSF-400L & PSF-400L2)
10W to 800W (PSF-800L & PSF-800Ls)

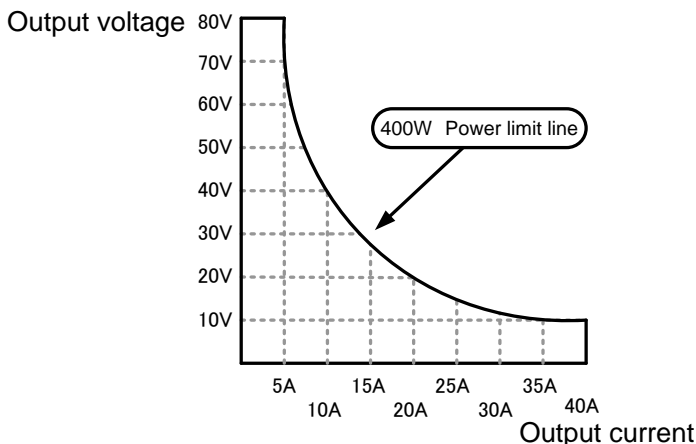
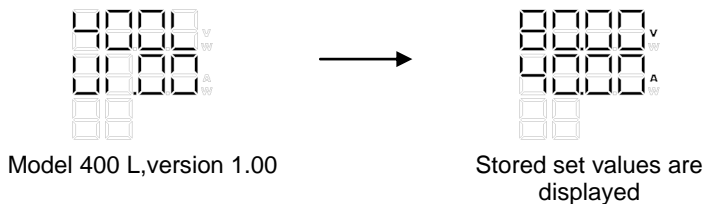

Fig.5-6 Operation Range of PSF-400L

5-4. Various Setting

First, press the POWER switch to turn on power. The power supply unit gives initial display (version and so forth) for several seconds and then displays the stored set values.

- ※ **The unit stores the set values automatically when the source voltage is cut off or the POWER switch is shut off.**



5-4-1. How to set voltage

※ Check which channel is selected before setting the voltage of the PSF-400L2 in order not to change the set value of the other channel.

- (1) Make sure that the **V** key is lit in green. If not, press the **V** key to turn it on.

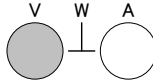

- (2) Set an intended value with the encoder.

5-4-2. How to set current

- (1) Make sure that the **A** key is lit in green. If not, press the **A** key to turn it on.

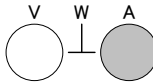

- (2) Set an intended value with the encoder.

5-4-3. How to set power

◆ See Section “5-4-4. How to change into power display” below.

- (1) Make sure that the **V** and **A** keys are lit. If not, press the **V** and **A** keys to turn them on.
(Both keys are lit in the power setting mode.)

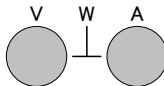

If the **A** key is pressed while keeping the **V** key depressed, the current display 7-segment LED enters the power display mode.

(The “W” LED on the side of the 7-segment LED is lit, indicating that the power is displayed.)

If the **V** key is pressed while keeping the **A** key depressed, the voltage display 7-segment LED enters the power display mode.

(The “W” LED on the side of the 7-segment LED is lit, indicating that the power is displayed.)

- (2) Set an intended value with the encoder.

5-4-4. How to change into power display

The voltage and current values are displayed normally. The power is displayed when both the **V** and **A** keys are pressed. Rotating the encoder in this condition changes the set power.

If the **A** key is pressed while keeping the **V** key depressed, the current display 7-segment LED enters the power display mode. (The “W” LED on the side of the 7-segment LED is lit, indicating that the power is displayed.)

If the **V** key is pressed while keeping the **A** key depressed, the voltage display 7-segment LED enters the power display mode. (Key depressed, the voltage display 7-segment LED enters the power display mode.)

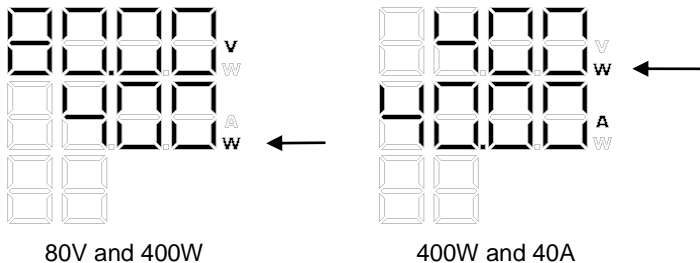

Fig.5-7 Power Display

5-4-5. How to output

The following output methods are available:

- Turning output on or off using the **OUTPUT** key.
- Turning output on or off using the **CHA** or **CHB** key (PSF-400L2 only).
- Turning output on or off using the external control function.

◆ See Section “5-5-7. External control (On/Off)” below.

※ **The output of the PSF series is turned on before the voltage lowers down to 0 (zero) volt if it is turned on and off quickly in the condition in a light load condition. The Off time must be 1 second or more when the output is turned on and off quickly.**

◆ See Section 2 “SPECIFICATIONS”.

(1) Turning output on or off using the **OUTPUT** key.

Press the **OUTPUT** key to turn output on or off. Output is on while this key is lit. On the PSF-400L2, pressing the **OUTPUT** key turns on or off the outputs of the channels A and B simultaneously, if the **CHA** **CHB** keys have been pressed to select the channels A and B

(2) Turning output on or off using the **CHA** **CHB** key. (PSF-400L2 only)

The **CHA** **CHB** keys are independent of each other, and it is possible to output through the channel A or B by pressing the **CHA** or **CHB** key to select the channel. However, output is disabled unless the **OUTPUT** key is lit.

※ If neither **CHA** nor **CHB** key is lit, the **OUTPUT** key will not go on even if it is pressed. (No output is provided.)

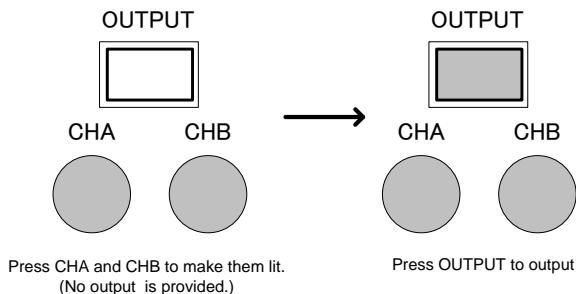
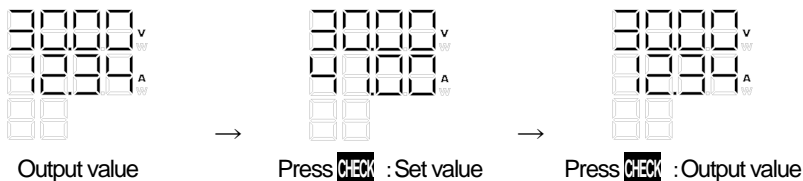

Fig.5-8 Output by Pressing **OUTPUT** key

5-4-6. How to display the set value in outputting condition

The power supply unit displays the output value in the outputting condition. Press the **ENTER** / **CHECK** key in this condition to change the displayed output value into the set value.

- ※ Every press of the **ENTER** / **CHECK** key alternates the setting mode and output mode.
- ※ When output value display is changed into set value display in the outputting condition, the **A** or **V** key blinks, indicating that the set value is being displayed.
- ※ The set value is changed if the encoder is rotated in the setting mode. The output value is changed if the encoder is rotated in the output mode. Do not touch the encoder to check the set value only.



5-4-7. How to rotate display panel by 90 degrees (for vertical installation)

The panel operation unit of the PSF Series may be rotated by 90 degrees to ensure easy operation in either horizontal or vertical installation. Hold the encoder and rotate the panel operation unit while pressing the ROTATE key below the encoder.

A “click” sound is heard and the panel operation unit is locked.



CAUTION

Be sure to confirm that the POWER switch is off before rotating the display panel.

If the display panel is rotated with power on, the set value may change due to rotation of the encoder. Be careful.

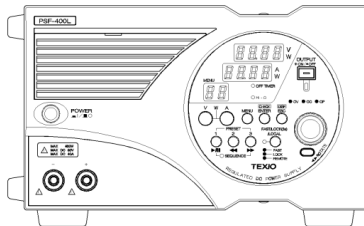

Horizontal installation

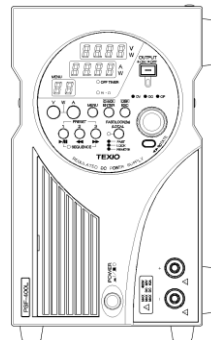

Vertical installation by
Rotating display panel

Fig.5-9 Rotating Display Panel

5-4-8. How to invalidate on-panel operations (Key lock function)

It is possible to invalidate operations conducted on the panel by pressing the FAST/LOCK (3s)/LOCAL key on the left of the encoder. Hold this key for three seconds or more to lock the keys. The keys are locked when the LED on the side of the key goes on red. To cancel the key lock condition, hold the FAST/LOCK (3S)/LOCAL key for three seconds or more.



CAUTION

This key serves as the FAST, LOCK (3s), and LOCAL keys. Even if the power supply unit is in the FAST state (green), the FAST state is canceled and the normal (SLOW) state is restored when the key is reset in order to avoid danger. Even in the key locked condition, the OUTPUT key is only functional to avoid danger. (output off only)

5-5. Various Functions Available on Menu

Introduction

- Every press of the **MENU** key changes the menu numbers.
- **MENU** options are available from “01” to “07”. (Options are available from “01” to “09” on the PSF-400LS2 only.)
- Press the **ESC / DISP** key to return from the **MENU** setting condition to the normal condition.
- To deactivate a function, select the setting mode of that function again from the menu and deactivate it.

Use the following keys to set the functions:

- **MENU** key ...Selects the menu options.
- **ENTER / CHECK** key ...Validates numeric values and items.
- **ESC / DISP** key ...Cancels the menu setting mode (and returns to the normal state).
- Encoder ...Selects numeric values and items.

Illustrations in the descriptions below represent the following:

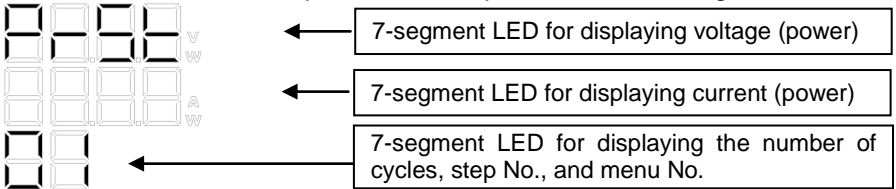

The basic flow of setting is as shown below:

- (1) Press the **MENU** key until an intended function number is displayed.
- (2) Press the **ENTER / CHECK** key to validate the function. Proceed to setting of the next item.
- (3) Set a numeric value or item with the encoder, and press the **ENTER / CHECK** key to validate it.
- (4) When all intended items have been set, press the **ESC / DISP** key to return to the normal state.



CAUTION

Any set value is validated only after the **ENTER / CHECK** key is pressed. Be sure to check if the value is set properly after setting it. Some functions may not be set at a time. See Table 5-1 below and carry out setting properly.

Set function	No.	Functions that cannot be set or used simultaneously
Preset	01	Sequence External(voltage/resistance)
OVP/OCP	02	-
Hi-Ω	03	-
Off timer	04	Sequence Delay External (On/Off)
Sequence	05	Preset Off timer External (voltage/resistance) External (On/Off) Delay Tracking
External (voltage/resistance)	06	Preset Tracking
External (On/Off)	07	Off timer Delay
Delay	08	Sequence Off timer
Tracking	09	Sequence External (voltage/resistance) External (On/Off)

Table 5-1

5-5-1. Preset function (01)

This function stores intended set values in advance. It is possible to assign set values to be stored to three PRESET keys.

The values shown below may be preset. Note that any other values may not be stored.

- Set voltage
- Set current
- Set power

CAUTION

Once the **MENU** key is pressed to activate the preset function, setting of the voltage, current and power is disabled. Set intended values to be stored in advance, and store them using the preset function.

- (1) Set a value to be stored and assigned to the PRESET key.
 - ◆ See Section “5-4. Various Setting” above.
- (2) Press the **MENU** key until menu number “01” is displayed.

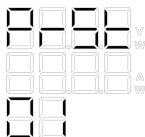

- (3) Press the **ENTER / CHECK** key. All PRESET keys blink.
 Press the button of an intended PRESET key.
 Only the pressed key is lit, the value is stored, and the normal state is restored.

5-5-2. OVP/OCP function (02)

■ **OVP:(Over Voltage Protection)**

The OVP function turns off output when the output voltage of the PSF Series exceeds the preset OVP value.

The setting range is from 1.0V to 84.0V. The resolution is 0.1V.

■ **OCP:(Over Current Protection)**

The OCP function turns off output when the output current of the PSF Series exceeds the preset OCP value.

The setting range is from 1.0 A to 42.0 A (800L: 1.0 A to 84.0 A).

The resolution is 0.1 A. The resolution is different in one-control parallel operation.

◆ See Section 2 “SPECIFICATIONS”.

- (1) Press the **MENU** key until menu number “02” is displayed.

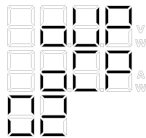

- (2) Every press of the **ENTER / CHECK** key alternates OVP and OCP setting displays. On the PSF-400L2, OVP and OCP setting display of the channel A appears first, which changes into OVP and OCP setting display of the channel B then.

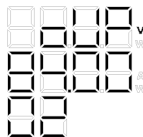

OVP setting

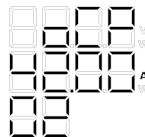

OCP setting

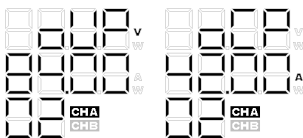

OVP and OCP setting of channel A

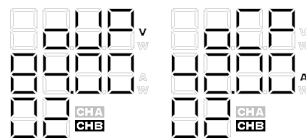

OVP and OCP setting of channel B

- (3) When an intended function is displayed, rotate the encoder to set an intended value, and press the **ENTER / CHECK** key to validate it. Setting is complete now.
- (4) Press the **ESC / DISP** key to return to the normal state.

5-5-3. Hi-Ωfunction (03)

Capacitors are connected to the output of the PSF Series power supply unit, which has a bleeder circuit for discharging the capacitors when output is turned off. This bleeder circuit pulls out certain-level current normally. When the Hi-Ωfunction is activated, the bleeder circuit is deactivated and the reverse current preventing diode necessary for charging the battery, capacitors, etc. may be omitted. When the Hi-Ωfunction is activated, the capacitors inside the PSF Series power supply unit are charged and may cause a dangerous accident, even after output is turned off. On the PSF Series power supply unit, it is possible to set the time of returning from the active Hi-Ωfunction to the normal condition (i.e., time duration until the internal bleeder circuit goes active) in units of five minutes (to a maximum of thirty minutes) in order to avoid dangerous accidents.

- (1) Press the **MENU** key until menu number "03" is displayed.

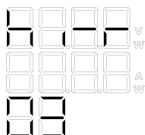

- (2) Press the **ENTER / CHECK** key to enter the Hi-Ωfunction setting mode. Select ON or OFF with the encoder.
(The Hi-Ωfunction is set to OFF before shipment.)

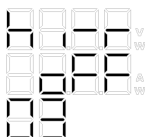

Initial setting

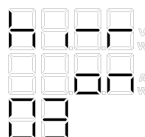

Hi-Ωfunction activated

- (3) Press the **ENTER / CHECK** key to validate setting. The function LED in the center of the panel goes on.

- OFF TIMER
- DELAY
- Hi-Ω(Lit)

- (4) Then, set the time of returning from the active Hi-Ωfunction to the normal condition with the encoder. Press the **ENTER** / **CHECK** key to validate setting.

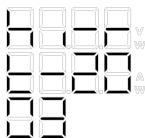

Returning to the normal condition 20 minutes later

- (5) Press the **ESC** / **DISP** key to quit the setting mode and return to the normal state.

CAUTION

When the Hi-Ωfunction is activated, the output terminals of the power supply unit keep on carrying voltage even after output is turned off. LED is blinking when Hi-Ωis activated. (since the internal capacitors remain charged). Voltage of 80V may stay at the maximum. Such a state is very dangerous. To avoid accidents, isolate the output terminals from the load cables completely with a relay, switch, etc. Handle the output terminals with the greatest care.

5-5-4. OFF timer function (04)

This function deactivates output of the power supply unit automatically. It is possible to set the timer-off period in units of ten minutes.

- (1) Press the **MENU** key until menu number “04” is displayed.

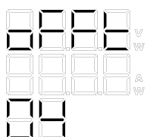

- (2) Press the **ENTER** / **CHECK** key to enter the Off Timer setting mode. Select ON or OFF with the encoder.
(The Off Timer is set to OFF before shipment.)

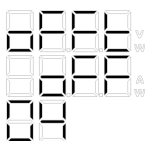

Initial setting

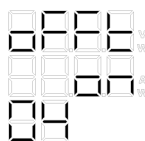

OFF timer activated

- (3) Press the **ENTER / CHECK** key to validate setting.
The function LED in the center of the panel goes on.

- OFF TIMER (Lit)
- DELAY
- Hi-Ω

- (4) Then, set intended time with the encoder.
Press the **ENTER / CHECK** key to validate setting. Setting is complete now.
The time may be set in units of ten minutes to a maximum of 99 hours and 50 minutes. The function LED begins to blink when the remaining time becomes less than five minutes.
The remaining time of the off-timer may be checked by pressing the ESP/DISP key while the off-timer is running. (On the 400L2, display changes in the order of CHA, CHB, and remaining time of the off-timer.)

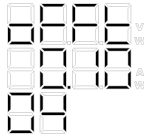

Timer set to ten minutes

- (5) Press the **ESC / DISP** key to quit the setting mode and return to the normal state.

5-5-5. Sequence function (05)

This function executes sequence programs, which are written in the PSF Series power supply unit using the optional interface board in advance, without anything else. Access the Texio homepage or consult its distributor for the procedures of writing sequence programs. The application software exclusive for sequence operation may be downloaded from our homepage.

The method of writing the sequence programs is described in the application software exclusive for sequence operation. The following shows an example of the sequence program and the screen of the exclusive application.

Note that it is impossible to rewrite the sequence programs on the PSF Series power supply unit.

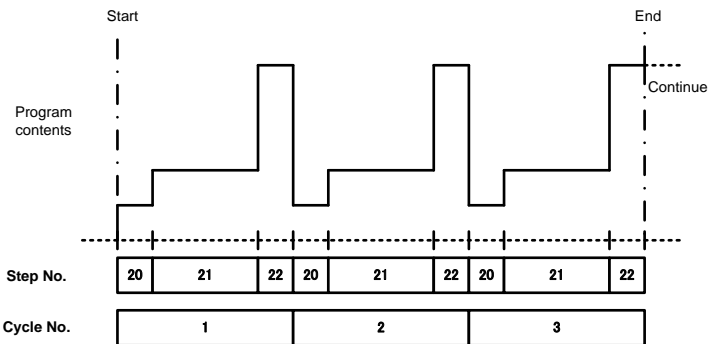

Fig.5-10 Repeating Steps 20 to 22 Three Times, Beginning with Step 20

CAUTION

If output is active at the end of the program as shown in Fig. 5-10, the power supply unit remains in the status of the last step even after completion of sequence operation. (Output stays active.)

The last step number must be OFF if output should be turned off on completion of sequence operation.

The power supply unit finishes sequence operation when the OUTPUT key is pressed during sequence operation.

If the OUTPUT key is pressed in a step, where output is active, during sequence operation, output remains active though sequence operation finishes.

- (1) Press the **MENU** key until menu number "05" is displayed.

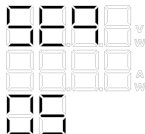

- (2) Press the **ENTER** / **CHECK** key to enter the sequence operation setting mode. Select ON or OFF with the encoder.
 (The sequence operation is set to OFF before shipment.)

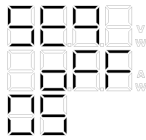

initial setting

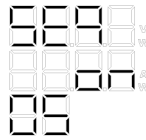

Sequence operation activated

- (3) Press the **ENTER** / **CHECK** key to validate setting.
 The LED below the PRESET key goes on.

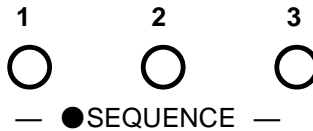

- (4) Set an intended start step number with the encoder.
 Press the **ENTER** / **CHECK** key to validate it.
 The setting range is from 0 to 99.

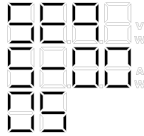

Starting sequence operation from step No. "00"

- (5) Then, set an intended end step number with the encoder.
 Press the **ENTER** / **CHECK** key to validate it.
 The setting range is from 0 to 99.

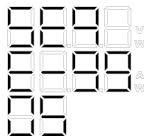

Finishing sequence operation at step No. "99"

- (6) Set the number of times of repeating the steps with the encoder.
Press the **ENTER** / **CHECK** key to validate it. Setting is complete.
Setting “---” repeats the steps infinitely.
The setting range is from 1 to 999 plus “—” (infinite).

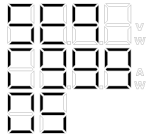

Repeating the steps 999 times

- (7) Press the **ESC** / **DISP** key to quit the setting mode and return to the condition capable of sequence operation.
- ◆ See Section 5.9 “Usage of Sequence Operation” for the method of using.

5-5-6. External control (external voltage, external resistance) (06)

- Constant-voltage (CV) control using external voltage

This function allows the user to control the voltage of the PSF Series power supply unit by applying external voltage to the unit. The output voltage is controlled from approximately 0V to the rated output voltage when 0V to 10V is applied from outside.

- Constant-current (CC) control using external voltage

This function allows the user to control the current of the PSF Series power supply unit by applying external voltage to the unit. The output current is controlled from approximately 0A to the rated output current when 0V to 10V is applied from outside.

- Constant-voltage (CV) control using external resistance

This function allows the user to control the voltage of the PSF Series power supply unit by connecting an external resistance with the unit.

The output voltage is controlled from approximately 0V to the rated output voltage when 0 Ω to 10k Ω is connected with the power supply unit.

- Constant-current (CC) control using external resistance

This function allows the user to control the current of the PSF Series power supply unit by connecting an external resistance with the unit.

The output current is controlled from approximately 0V to the rated output voltage when 0 Ω to 10k Ω is connected with the power supply unit.

- ◆ See Sections “5-7-2. Constant-voltage (CV) control with external voltage or resistance” and “5-7-3. Constant-current (CC) control with external voltage or resistance” below.



CAUTION

The PSF Series power supply unit is incapable of simultaneous external voltage and external resistance controls like controlling the constant voltage (CV) with external voltage and controlling the constant current (CC) with external resistance.

(1) Press the **MENU** key until menu number “06” is displayed.

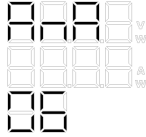

(2) Press the **ENTER / CHECK** key to enter the external control setting mode. Select the intended control means (external voltage or external resistance) with the encoder, and press the **ENTER / CHECK** key. (The external control is set to OFF before shipment.)

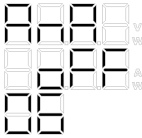

Initial setting

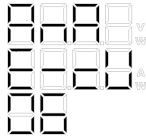

External voltage

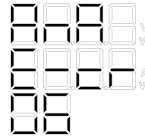

External resistance

(3) Select the objective of external control with the encoder. The objectives are displayed as shown below.

- CV = Constant voltage
- CC = Constant current
- IN = Control on the panel operation unit or from the Personal computer
- OUT = through the optional board External control

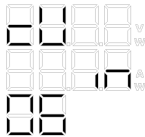

Controlling constant voltage from panel operation unit

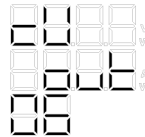

Constant voltage by external control

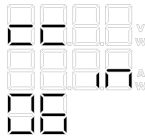

Controlling constant current from panel operation unit

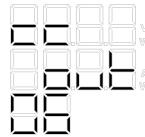

Constant current by external control

(4) Finally, press the **ENTER / CHECK** key to validate setting. Setting is complete now.

(5) Press the **ESC / DISP** key to quit the setting mode and return to the normal condition.

5-5-7. External control (On/Off) (07)

It is possible to turn on or off the output by shorting or opening the signal pins with external contact signals.

Short circuit: Output On, Open: Output Off

◆ See Section “5-7-4. Output On/Off with external contacts” below.

(1) Press the **MENU** key until menu number “07” is displayed.

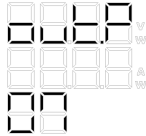

(2) Press the **ENTER** / **CHECK** key to enter the external output On/Off control setting mode. Select On or Off with the encoder, and press the **ENTER** / **CHECK** key again to validate the setting. Setting is complete now. The output control modes are displayed as shown below.

IN = On/Off control with the OUTPUT key

OUT = On/Off control with external contacts

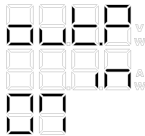

On/Off control with the
OUTPUT key

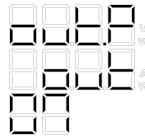

External On/Off control)

(3) Press the **ESC** / **DISP** key to quit the setting mode and return to the normal condition.

5-5-8. Delay function (08)

The delay function is available on the two-output model (PSF-400L2) only. It causes a delay of the channel B output for intended time (in units of seconds) from the reference point, which is output of the channel A.

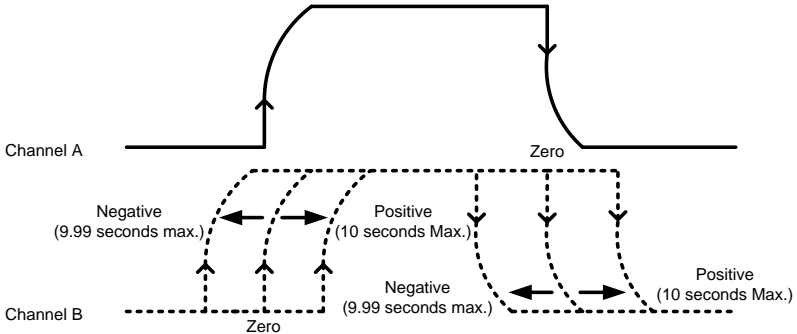
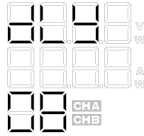
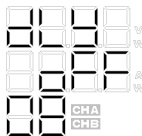

Fig.5-11 Temporal Concept of Delay Function

- (1) Press the **MENU** key until menu number "08" is displayed.



- (2) Press the **ENTER / CHECK** key to enter the delay function setting mode. Select On or Off with the encoder.
(The delay function is set to Off before shipment.)



Delay OFF

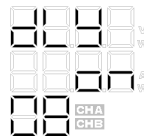

Delay ON

- (3) Press the **ENTER / CHECK** key to validate setting. The function LED in the center of the panel goes on.

- OFF TIMER
- DELAY (Lit)
- Hi-Ω

- (4) Set the rise delay time with the encoder. When positive time is set, output of the channel B is delayed from the channel A. On the contrary, the channel B begins to output first when negative time is set. It is possible to set the delay time in the range from -9.99 seconds to +10.00 seconds in units of 10 ms.

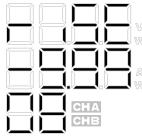

Turning off channel B
output 9.99 seconds earlier



Turning off channel B
output 10.00 seconds later

- (5) Set the fall delay time with the encoder, and press the **ENTER / CHECK** key. Setting is complete now.

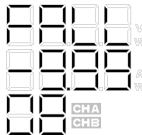

Turning off channel B
output 9.99 seconds earlier

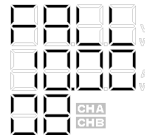

Turning off channel B
output 10.00 seconds later

- (6) Press the **ESC / DISP** key to quit the setting mode and return to the normal condition.

5-5-9. Tracking function (09)

The tracking function is available on the two-output model (PSF-400L2) only. It allows the setting of both channels to be changed at a time. When the value of the channel A is changed into that of the channel B automatically in the condition where the tracking function is active (ON). Then, the values of both channels change simultaneously. Hereafter, the values of both channels change simultaneously.

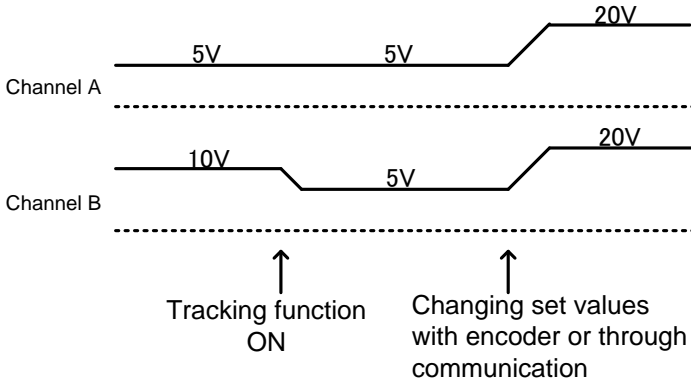
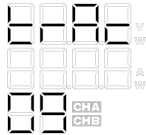
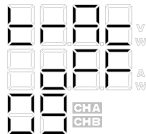

Fig.5-12 Tracking Operation

- (1) Press the **MENU** key until menu number “09” is displayed.



- (2) Press the **ENTER** / **CHECK** key to enter the tracking function setting mode. Select On or Off with the encoder.
(The tracking function is set to OFF before shipment.)



Initial setting

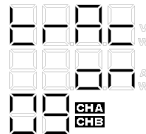

Tracking ON

- (3) Press the **ENTER** / **CHECK** key to validate setting.
The CHA and CHB LEDs on the right of the channel LED go on.

- (4) Press the **ESC** / **DISP** key to quit the setting mode and return to the normal condition. “Ab” is displayed on the 7-segment MENU LED, indicating that the tracking function is activated.

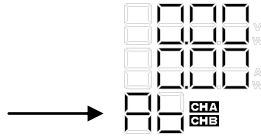

Display when tracking function is activated

5-5-10. Master-slave function (10)

CAUTION

The Hi-Ωfunction (03) is not available for the master-slave operation. Which is only available on the same models in series connection.

On slave units in series connection, the output voltages of the slave units alone are displayed (when output is on).

No panel operations are enabled on the slave units. Besides, the Off Timer, sequence and external control functions of the slave units are initialized. On slave units in parallel connection, “----” is displayed and the monitor value is not displayed.

(The monitor value is displayed on the master unit.)

- ◆ See Sections “6-2. One-Control Parallel Operation” and “6-3. One-Control Series Operation” below.

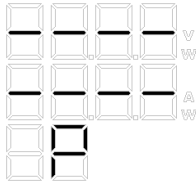

Display on slave unit in parallel connection

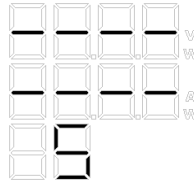

Display on slave unit in series connection

- (1) The set condition is established when the Power switch is thrown while holding the **MENU** key.
- (2) Select an intended operation mode with the encoder and press the **ENTER / CHECK** key to validate the setting.
(The master-slave function is set to OFF before shipment.)

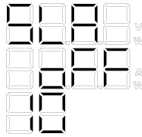

Initial setting: Single unit operation or master unit in series connection

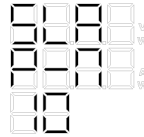

Master unit in parallel connection

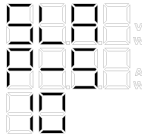

Slave unit in parallel connection

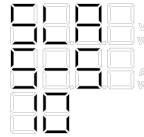

Slave unit in series connection

- (3) Set the total power with the encoder when the unit is selected as the master unit in parallel connection.

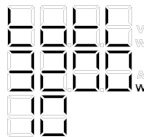

Total power of 3200 W

- (4) Press the **ESC / DISP** key to quit the setting mode and return to the normal condition.
- (5) Press the **ESC / DISP** key to exit the setting condition and return to the normal condition.

5-6. Output Voltage Remote Sensing

The PSF Series power supply unit has an output voltage remote sensing function. It eliminates influences of voltage drop between the power supply unit and load, which is caused by the contact resistance or the resistance of the load cable conductors.

It compensates for a voltage of 1V on the single side.

CAUTION

When the voltage remote sensing function is used, the voltage at the front and rear output terminals of the power supply unit must not exceed the rated voltage. Be very careful. If the load is too far from the power supply unit, inductance and capacity of the load cables may cause oscillation. To avoid such oscillation, connect an electrolytic capacitor of several hundred μF to several thousand μF to the load terminals.

- (1) Make sure that the POWER switch is off before starting work.
- (2) Disconnect the wire that short-circuits the + and +S terminals or - and -S terminals of four-terminal block on the left of the output terminals on the rear panel.
- (3) Connect the positive sensing terminal (+S) with the positive side of the load and the negative sensing terminal (-S) with the negative side of the load as shown below. If the sensing wires are disconnected, control becomes unstable and voltage over the set voltage is applied to the load. Connect the sensing wires firmly.

※ **Current of approximately 1mA flows through the sensing wires at the rated output voltage. Use AWG 26 to 18 wires as the sensing wires.**

◆ See Section “5-2. Connecting Load with Output Terminals” above.

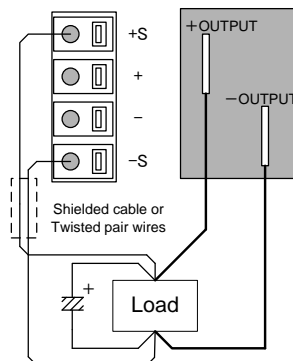

Fig.5-13 Remote Sensing Connection

5-7. External Control Functions

Following connector for external control is supplied with the product.

1. XG5M-2635-N (manufactured by OMRON Corporation)

This section describes how to assemble the external control connector.

5-7-1. To assemble the connector XG5M-2635-N

The mounting of the wire to the contact, in order to improve the reliability, please use the (OMRON) special tool XY2B-7006. In addition, the application wire rod is twist line AWG28 - AWG26, external form $\Phi 1.1$ - $\Phi 1.3$.

Specifically, please review an instruction manual of XY2B-7006. For details, please confirm the operation manual of XY2B-7006.

In the case of faulty wiring or wiring change, please use the (OMRON) special tool XY2E-0001 that is withdrawn from the housing contact. For details, please confirm the operation manual of XY2E-0001.

5-7-2 Output voltage monitor and output current monitor

It is possible to monitor the output voltage and output current of the PSF Series power supply unit in voltage.

This section describes how to monitor the output voltage and output current of the two-output model (PSF-400L2). Those of a single-output model may be monitored in the same manner as monitoring the CHA outputs described below.

※ **The internal impedance of the voltage and current monitoring circuits is approximately 1kΩ.**

Be careful not to flow current over 1mA through the monitoring circuits.

(1) Voltage monitor

CHA: Pins 17 and 16 (COM), CHB: Pins 8 and 7 (COM)

(2) Current monitor

CHA: Pins 18 and 16 (COM), CHB: Pins 9 and 7 (COM)

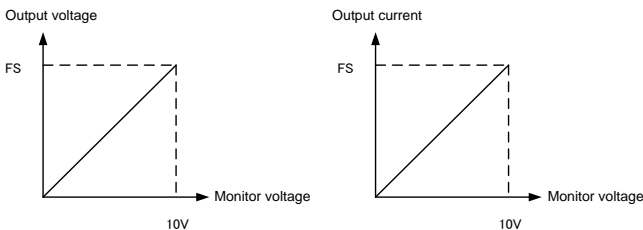
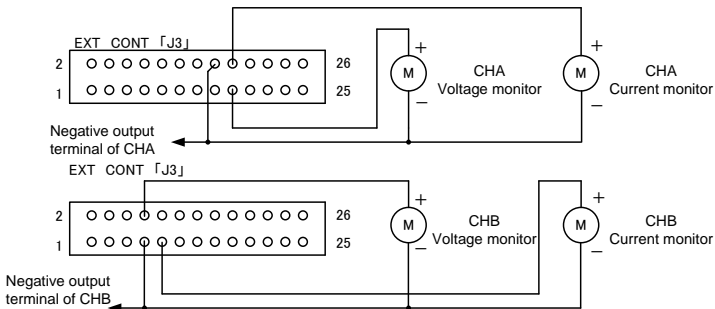

Fig.5-14 Monitor Output Terminal

5-7-3. Constant-voltage (CV) control with external voltage or resistance

It is possible to control the output voltage by external voltage or external resistance through the connector J3 (EXT CONT) on the rear panel if external control is selected in Section “5-5-6. External control (external voltage, external resistance)” above. For the setting procedures, see Section “5-5-6. External control (external voltage, external resistance)”.

CAUTION

The negative side of the external voltage is connected with the negative output terminal of the power supply unit. Use the external voltage source in the floating condition to avoid accidents or malfunctioning.

If the external resistor is disconnected for some reason in the external control mode, excessive voltage is applied to the output. Use a shorting type switch if the constant voltage is to be controlled by changing fixed resistors with the switch.

Control by external voltage and control by external resistance use the same pins. Check with control is selected, control by external voltage and control by external resistance, before using the pin.

CHA : Pins 14 and 16 (COM)

CHB : Pins 5 and 7 (COM)

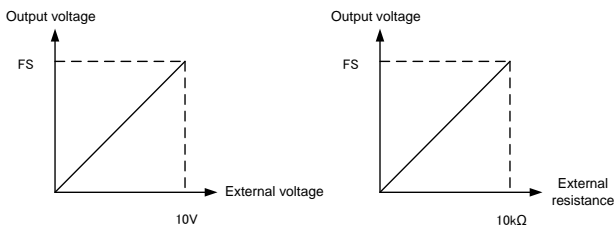
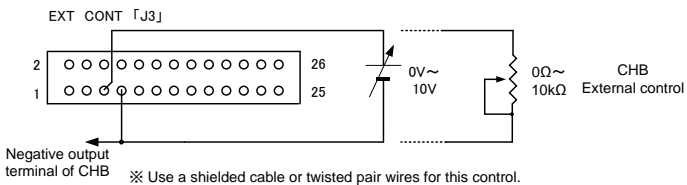
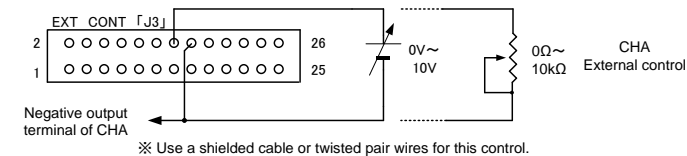

Fig.5-15 External Voltage/Resistance Control Terminal(CV)

5-7-4. Constant-current (CC) control with external voltage or resistance

It is possible to control the output current by external voltage or external resistance through the connector J3 (EXT CONT) on the rear panel if external control is selected in Section “5-5-6. External control (external voltage, external resistance)” above. For the setting procedures, see Section “5-5-6. External control (external voltage, external resistance)”.

CHA : Pins 15 and 16 (COM)

CHB : Pins 6 and 7 (COM)

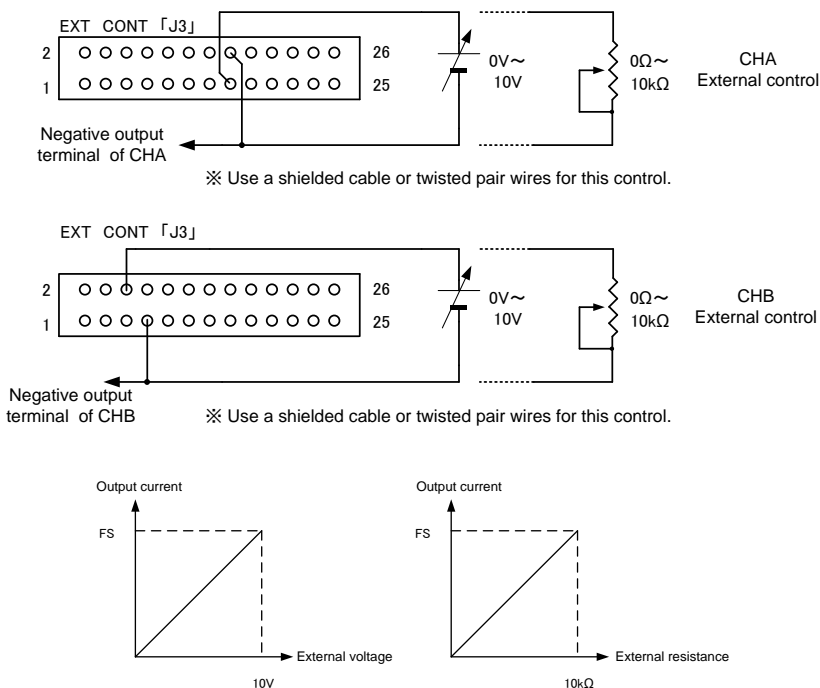

Fig.5-16 External Voltage/Resistance Control Terminals (CC)

5-7-5. Output ON/OFF with external contacts

It is possible to turn on or off output with external contacts if the external control function is activated in Section “5-5-7. External control (On/Off)” below. For the setting procedures, see Section “5-5-7. External control (On/Off)”.

CHA : Pins 21 and 22 (COM)

CHB : Pins 12 and 13 (COM)

Short : OUTPUT ON

Open : OUTPUT OFF

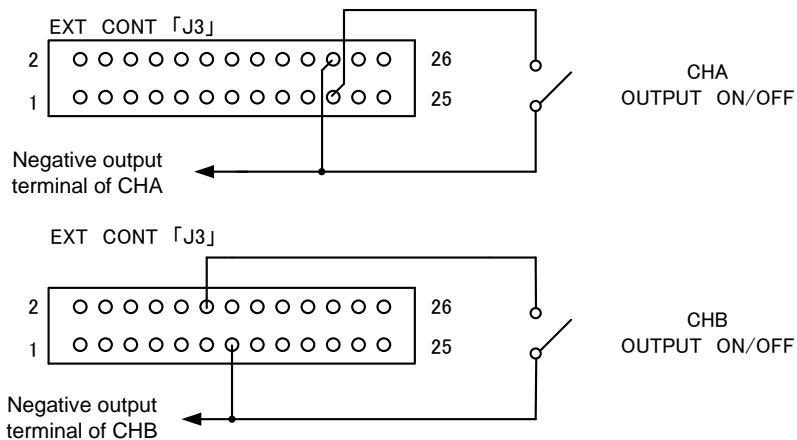

Fig.5-17 Output ON/OFF Terminals with External Contacts

5-7-6. Alarm function using external contacts

It is possible to bring the PSF Series power supply unit into the alarm status forcedly by short-circuiting the external contacts. Output is turned off and “HARD” is displayed on the 7-segment LED when the PSF Series power supply unit is brought into the alarm status. Cut off input power or shut off the POWER switch to cancel the alarm status.

CHA : Pins 20 and 22 (COM)

CHB : Pins 11 and 13 (COM)

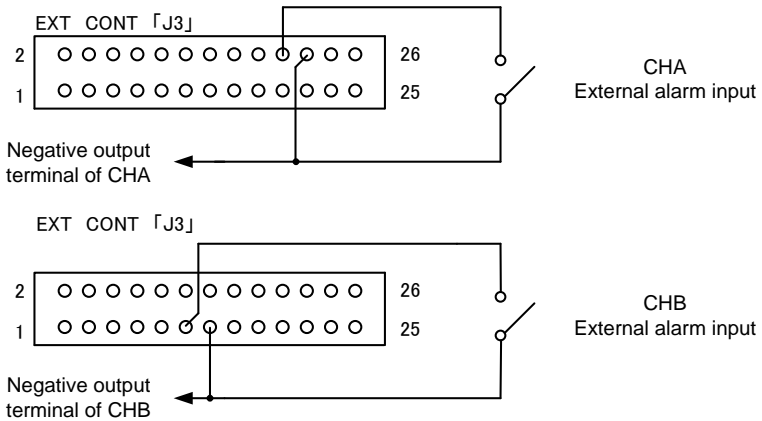

Fig.5-18 External Alarm Input Terminals

5-7-7. Various status signals (CV, CC & ALARM)

It is possible to check the status using the open collector output.

- Constant-voltage (CV) status signal
This status signal goes Low when the PSF Series power supply unit enters the constant-voltage (CV) status.
- Constant-current (CC) status signal
This status signal goes Low when the PSF Series power supply unit enters the constant-current (CC) status.
- Alarm status signal
This status signal goes Low when the PSF Series power supply unit enters the alarm status.

PC3H7 made by SHARP

Item		Symbol	Max. rating	Unit
Output	Collector-emitter voltage	V_{CEO}	66	V
	Emitter-collector voltage	V_{ECO}	6	V
	Collector current	I_C	50	mA
	Collector loss	P_C	150	mW
Total allowable loss		P_T	170	mW
Isolation voltage		BV_S	2500	Vrms

CHA : Constant-voltage (CV) status: Pins 23 and 26 (COM)
 Constant-current (CC) status: Pins 24 and 26 (COM)
 Alarm status: Pins 25 and 26 (COM)

CHB : Constant-voltage (CV) status: Pins 4 and 1 (COM)
 Constant-current (CC) status: Pins 3 and 1 (COM)
 Alarm status: Pins 2 and 1 (COM)

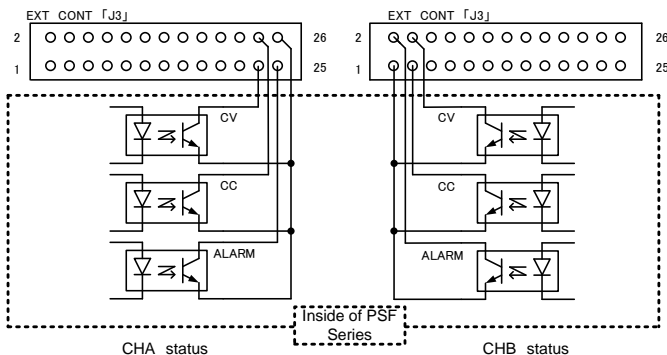
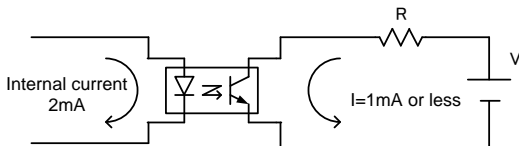

Fig.5-19 Status Terminals

⚠ CAUTION



※ Select and use proper voltage or resistance so that the open collector current does not exceed 1mA.

Fig.5-20 Photo coupler current

5-8. Activating output when turning on power

Using the output on/off function with the external contacts shown in Section “5-7-4. Output ON/OFF with external contacts”, it is possible to turn on output automatically as soon as power is input to the power supply unit.

※ **The value stored automatically when the source voltage is cut off or the POWER switch is shut off is output. Check the set value again before using this function.**

5-9. Usage of sequence Function

Using the sequence function shown in Section “5-5-5. Sequence function(05)”, it is possible to execute the sequence programs written in the power supply unit in advance through the optional interface board on the power supply unit without the need of any other devices. See Section “5-5-5. Sequence function(05)” above for the procedures of setting the sequence operation.

Download the application software exclusive for the sequence operation from our homepage and create sequence programs in advance.

- (1) Write sequence programs through the interface board.
- (2) Activate the sequence function shown in Section “5-5-5. Sequence function(05)”.
- (3) Execute sequence operation with the **PRESET** key(s).
Each **PRESET** key has two functions. Operations caused by pressing the **PRESET** keys and **OUTPUT** key are different in the normal operation and sequence operation modes. These keys cause the following operations in sequence operation.

<Normal operation>

PRESET 1

PRESET 2

PRESET 3

OUTPUT

<Sequence operation>

Starts or gives a pause to operation. ()



Jumps to the step of the number one smaller than the step number. ()

Jumps to the step of the number one larger than the step number. ()

Finishes sequence operation.

CAUTION

The **OUTPUT** key does not start sequence operation.

Use the **PRESET 1** () key to start sequence operation. Even if the sequence function is activated and the “● SEQUENCE LED” is lit, the sequence operation will not start unless the **PRESET 1** () key is pressed. Other functions than the preset function work normally even when the “● SEQUENCE LED” is lit.

When the **OUTPUT** key is pressed during sequence operation, sequence operation finishes. Note that completion of sequence operation is different from deactivation of output in normal operation.

- (4) Display in sequence operation is different from that in normal operation. It is as shown below. When the **ESC / DISP** key is pressed in sequence operation, the step number is displayed on the voltage 7-segment LED and the number of cycles is displayed on the current 7-segment LED. Press the **ESC / DISP** key again to return to the set value display condition (or the output value display condition while output is given).

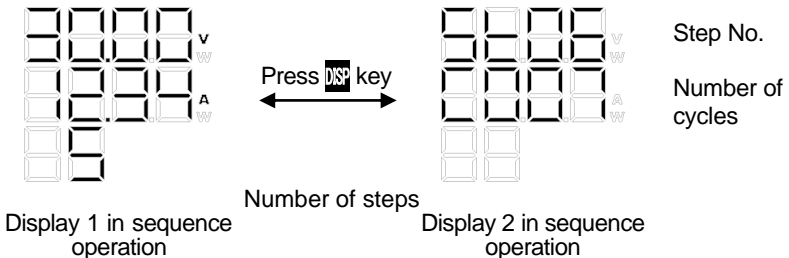

- (5) During sequence operation, the “● SEQUENCE LED” below the **PRESET** key blinks, indicating that sequence operation is being executed. To stop sequence operation halfway, press the **OUTPUT** key or deactivate the sequence function as shown in Section “5-5-5. Sequence function (05)”.

6. OTHER FUNCTIONS

6-1. Display in alarm status

When the PSF Series power supply unit enters the alarm status or the function described in Section “5-7-5. Alarm function using external contacts” is used, the alarm code shown below is displayed, indicating that an alarm occurs in the power supply unit. When an alarm occurs, the power supply unit turns off output and stays in the alarm status. When a protection function (excluding OVP and OCP described in Section “5-5-2. OVP/OCP function (02)”) works, all operations (panel operation, etc.) are disabled and the power supply unit stops operation. Press the **ESC** / **DISP** key for one second to reset the OVP or OCP alarm (described in Section “5-5-2. OVP/OCP function (02)”). Turn off the input power source or shut off the POWER switch and throw it again to reset the protection function.

(1) OVP alarm

This alarm code is displayed if the output voltage exceeds the preset OVP value.

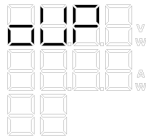

(2) OCP alarm

This alarm code is displayed if the output current exceeds the preset OCP value.

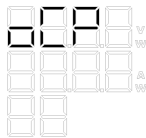

(3) OHP alarm

The OHP alarm is displayed if the temperature at the internal detection point exceeds the set temperature. The displayed alarm differs with the models as shown below.

On the 400L2, the OHP alarm is displayed for each channel.

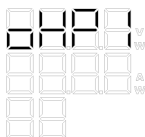

(400L,800L)

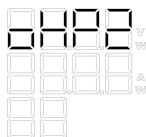

(800L)

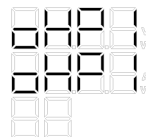

(400L2)

(4) HARD alarm

This alarm is displayed in the following conditions.

Over-voltage (OVP)	Output is turned off if the voltage exceeds 110% of the rated output voltage.
Over-current (OCP)	Output is turned off if the current exceeds 110% of the rated output current.
Alarm using external contacts ALARM	Alarm is caused when the contacts are short-circuited. For details, see Section “5-7-5. Alarm function using external contacts” above.

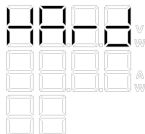

Display in case of HARD alarm

6-2. One-Control Parallel Operation (excluding PSF-400L2)

The PSF Series power supply units are capable of one-control parallel operation of up to four units, including the master unit. When executing one-control parallel operation using master units, the master and slave units should be set properly in advance.

◆ For the setting procedures, see Section “5-5-10.

Master-slave function” above. Connect the master and slave units with the optional parallel signal cables OP-22P. The parallel connection kit for horizontal installation OP-21A, parallel connection kit for vertical installation OP-21B and joint kit JK-10 are also available by option. Use these kits as the necessity requires.

The sum of the master unit current and slave unit current is displayed on the master unit.

◆ See Section 2 “SPECIFICATIONS” for the displayed items and setting resolution in one-control operation.

The current displayed on the master unit is the sum of the current of the master and slave units.

Output depends on the master unit. When the OUTPUT key of the master unit is thrown, outputs of the slave units are turned on automatically.



CAUTION

Improper wiring or setting may cause failures. Recheck the setting before starting one-control operation.

If the load cables of a slave unit are disconnected, excessive voltage is applied to the slave unit instantaneously and a “HArd” alarm occurs. Check if the cables are connected properly. Repair improper connection. The master unit displays the total current. If the actual value is remarkably different from the set current and/or output current, improper power may possibly be set in the setting shown in Section “5-5-10. Master-slave function”. Recheck the set power.

While single control parallel operation, current indication of the master unit may fluctuate largely due to influence of load wire resistance. In such case, use optional connection kit, OP-21A (Horizontal Installation Connection Kit), OP-21B (Vertical Installation Connection Kit) or a low impedance load wire.

Use PSF-400L as a master unit in case of single control parallel operation with PSF-400L and PSF-800L.

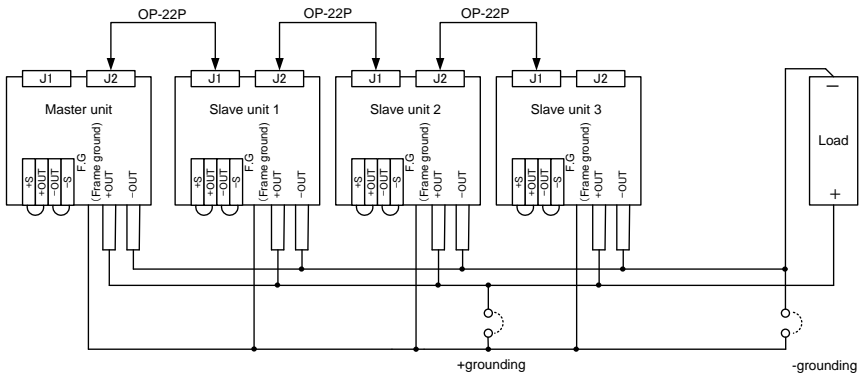

Fig.6-1 Parallel Connection

6-3. One-Control series operation (excluding PSF-400L2)

The PSF Series power supply units are capable of one-control series operation of up to two units, including the master unit. When executing one-control series operation using master units, the slave unit should be set properly in advance.

- ◆ For the setting procedures, see Section “5-5-10. Master-slave function” above.

Connect the master and slave units with the optional series signal cables OP-22S. The joint kit JK-10 is also available by option.

Use it as the necessity requires.

In one-control series operation, voltage is only displayed on the slave unit (when output is turned on).

The voltage displayed on the master or slave unit is the output voltage of the unit alone.

- ◆ See Section 2 “SPECIFICATIONS” for the displayed items and setting resolution in one-control operation.

Output depends on the master unit. When the OUTPUT key of the master unit is thrown, output of the slave unit is turned on automatically. Connect the master and slave unit with the optional OP-22S.

- ※ **Improper wiring or setting may cause failures.**
Recheck the setting before starting one-control operation.

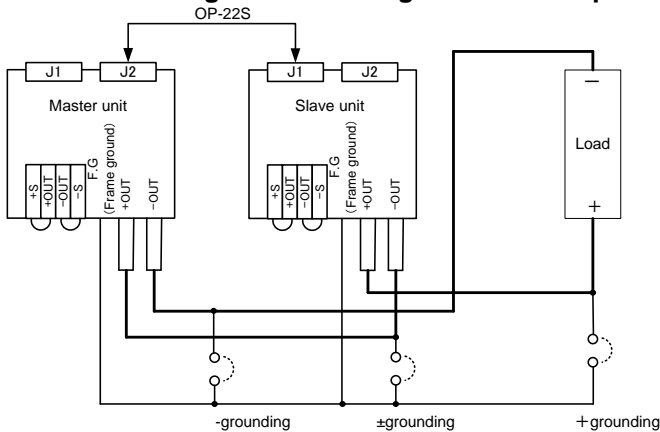

Fig. 6-2 Series Connection

6-4. Power Extension using PSF-800LS (Parallel Connection Only)

The model PSF-800LS (slave-only unit) is especially designed for power expansion.

It is possible to increase output up to 3200W (max.) in one-control parallel operation (if the PSF-800L is the master unit).

PSF-1200L :PSF-400L + PSF-800LS

PSF-1600L :PSF-800L + PSF-800LS

For the connection method, see Section “6-2. One-Control Parallel Operation” above.

※ Note that the PSF-800LS is not applicable to series operation.

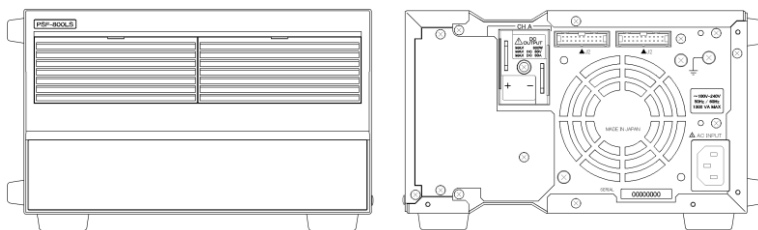

Fig.6-3 Front and Rear panel of PSF-800LS

6-4-1. How to use the PSF-800LS

The PSF-800LS is not equipped with a power switch.

As soon as the master unit is turned on in parallel operation described in Section “6-2. One-Control Parallel Operation”, the PSF-800LS is turned on. In other words, the PSF-800LS cannot be used alone. Check again if the AC power cable, signal cables and load wires are connected properly before using it. Improper wiring or setting may cause troubles.

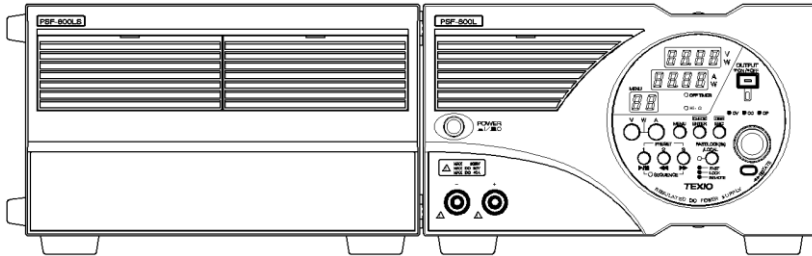

Fig.6-4 Connection Example of Slave-Only Unit (Horizontal Installation)

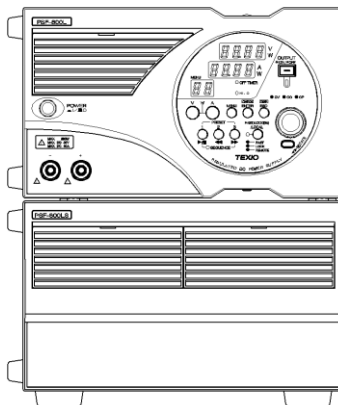

Fig.6-5 Connection Example of Slave-Only Unit (Vertical Installation)

6-4-2. Master-slave connection using optional kits

The optional kits facilitate master-slave connection of two units and offer sufficient rigidity.

How to Connect Units Vertically

- (1) Remove the rubber shoes from the bottom of unit A. (Keep the removed rubber shoes and screws with care not to lose them.)
- (2) Fix the joint kit (JK-10) to the top panel of the unit B with the flat countersunk head screws supplied with the kit.
(Four positions)
- (3) Place the units as shown in Fig. 6-6 below so that the projections of the JK-10 on the unit B are inserted in the holes in the unit A, from which the rubber shoes are removed above.
- (4) Shift the unit A, and fix the rear panel to the brackets of the joint kit (JK-10) firmly with the screw with washer supplied with the kit.
(Two positions)

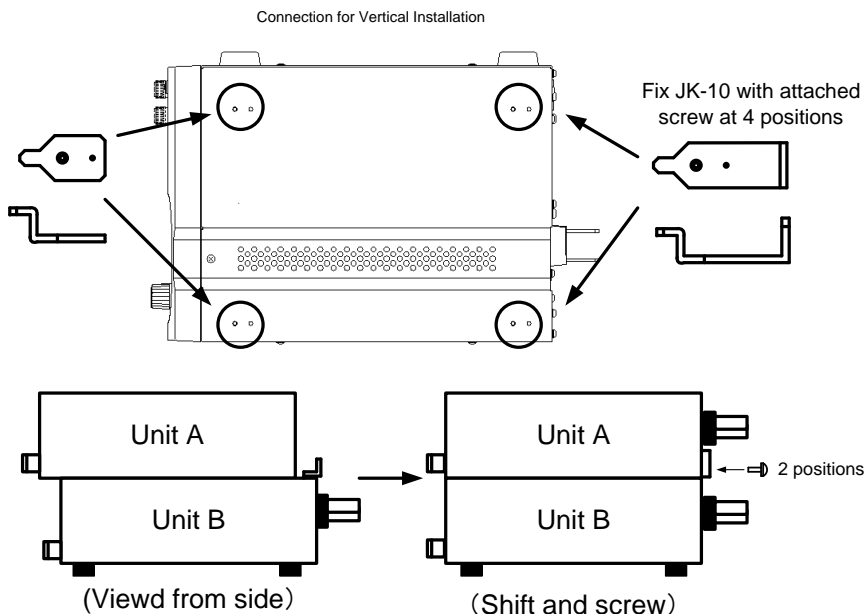

Fig.6-6 Connection for Vertical Installation

How to Connect Units Horizontally

- (1) Remove the rubber shoes from the bottom of unit A. (Keep the removed rubber shoes and screws with care not to lose them.)
- (2) Fix the joint kit (JK-10) to the side with no rubber shoes of the unit B with the flat countersunk head screws supplied with the kit. (Four positions)
- (3) Place the units as shown in Fig. 6-7 below so that the projections of the JK-10 on the unit B are inserted in the holes in the unit A, from which the rubber shoes are removed above.
- (4) Shift the unit A, and fix the rear panel to the brackets of the joint kit (JK-10) firmly with the screw with washer supplied with the kit. (Two positions)

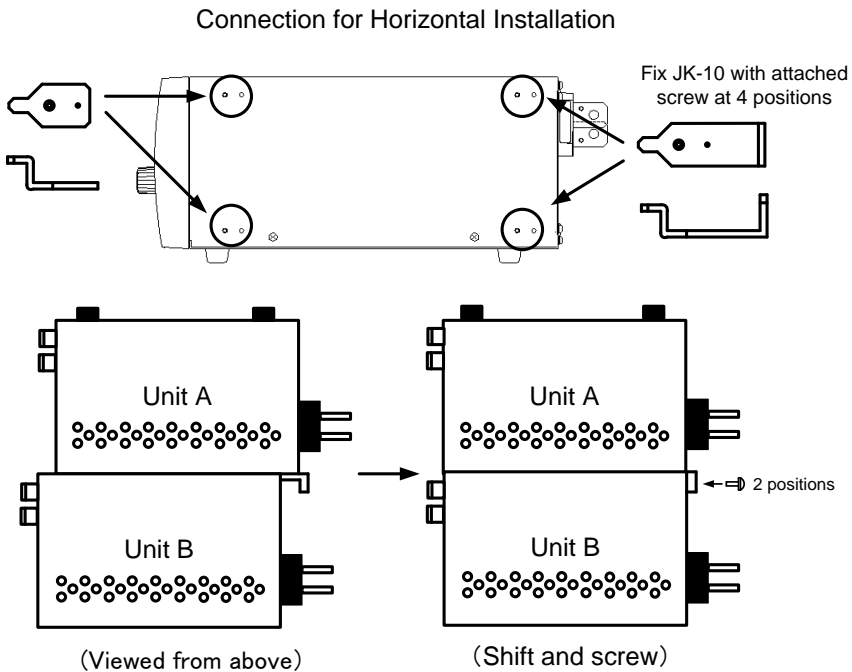

Fig.6-7 Connection for Horizontal Installation

(5) Connect the bus bar (OP-21A or OP-21B) as shown in Fig. 6-7.

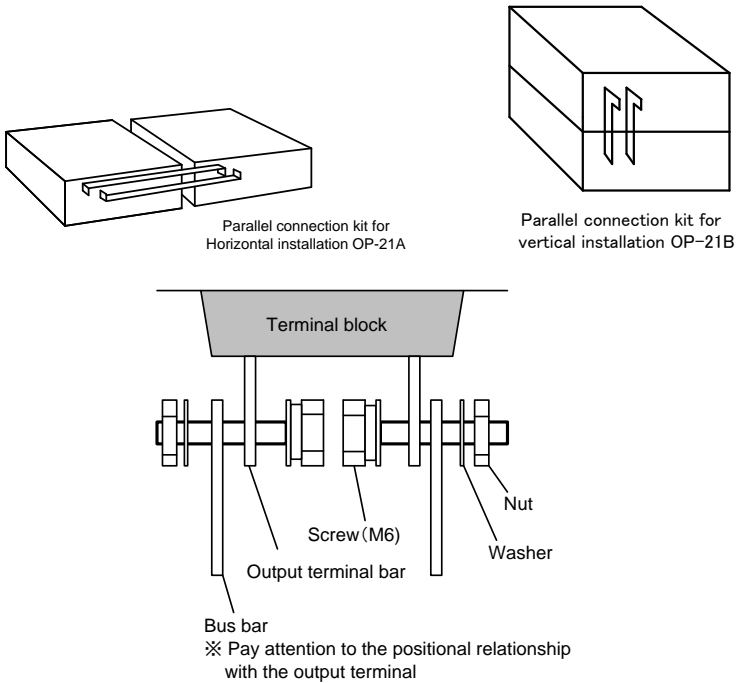
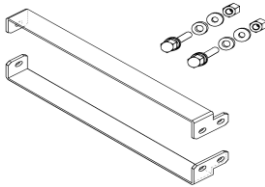

Fig.6-7 Bus Bar Connection and Fixing Output Terminal

7. OPTION

7-1. Accessories

The options shown below are available for the PSF Series power supply unit.



- (1) OP-21A
(Bus bar+JK-10+OP-22P)
Parallel connection kit
for horizontal installation

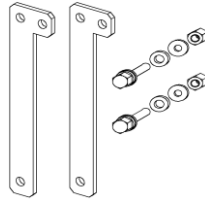

- (2) OP-21B
(Bus bar+JK-10+OP-22P)
Parallel connection kit
for vertical installation

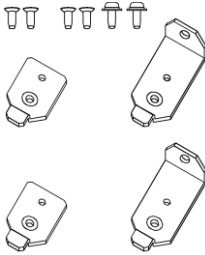

- (3) JK-10
Joint kit

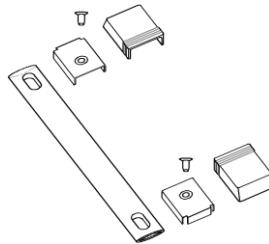

- (4) HK-10
Handle kit

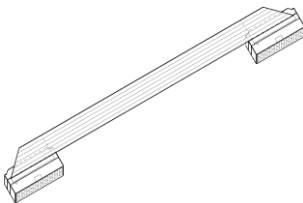

- (5) OP-22P
Parallel signal cable

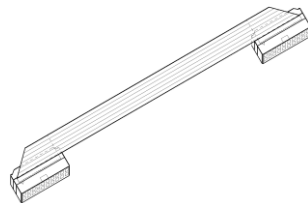

- (6) OP-22S
Series signal cable

7-2. Interface Boards

Two types of optional interface boards shown below are available:

- (1) IF-60GP: GP-IB+local bus
- (2) IF-60RU: USB+RS-232C+local bus

8. EXTERNAL CONTROL THROUGH INTERFACE BOARD

8-1. Remote Control

It is possible to control the PSF Series power supply unit from a Personal computer or sequencer through communication when the optional interface board is mounted in it. Two types of interface boards IF-60GP and IF-60RU are available for communication with a Personal computer through GP-IB, RS-232C and USB interfaces. These boards enable a maximum of ten units to be connected with the master unit connected with a Personal computer through a local bus. The connected units may be controlled as the slave units.

※ The terms “master unit” and “slave unit” here are the same as the master and slave unit for power extension described in Section However, they have different meanings. Do not confuse them.

※ It is impossible to mount the optional interface board in the PSF-800LS.

8-2. Interface connectors

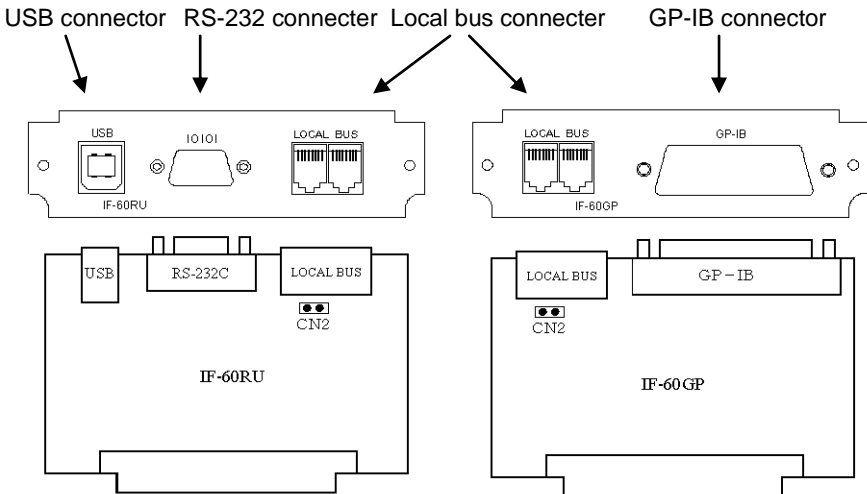

Fig.8-1 Sketch of Interface Boards

8-3. Specifications

8-3-1. Specifications of IF-60RU

RS-232C section	
Specifications	Conforms to the RS-232C Standards.
Data transmission speed	57600[bps]
Data bit	Data: 8 [bits], stop bit: 1 [bit], parity: none
Max. cable length	10[m]
Connector type	D-sub, 9-pin, plug
Applicable cable	Mass-marketed interlink cable (Socket 9-pin to socket 9-pin)
Q'ty of connectable units	One-to-one connection only

USB section	
Specifications	Conforms to the USB Standards, Revision .2.0. Full speed: 12 [Mbps]
Connector type	USB series B
Device class	Exclusive device class. Drive for Windows is offered separately.
Vendor code	098F
Product code	1006
Power supply	Self-powered only
Q'ty of connectable units	Maximum of 30 units are connectable through USB hubs.

Local bus section	
Specifications	Conforms to the RS-485 Standards. Exclusive protocol.
Max. cable length	10 [m]
Connector type	RJ-11 (6-pin modular) Pin 2 (D+), pin 3 (D-)
Applicable cable	Exclusive modular cable CB-0603S, -0615S, -0630S & -06100S (Our product Nos.)
Q'ty of connectable units	Maximum of 10 units are connectable through daisy chain connection.
Terminator	Built-in. May be turned on/off with jumper pin.
Q'ty of ports	2 ports, non-directional

8-3-2. Specifications of IF-60GP

GP-IB section	
Specifications	Conforms to IEEE488-1978.
Interface functions	SH1, AH1, T6, L4, SR1, RL1, PR0, DC1, DT0, C0, & E1
Address setting	Address between 1 and 30 may be set freely.
Delimiter	LF, EOI, & LF + EOI
Listener function	Output conditions of controlled power supply units may be set.
Talker function	Output conditions and setting conditions of controlled power supply units may be detected.
Service request function	Occurrence of alarms and errors and presence or absence of responses are reported.
Q'ty of connectable units	Maximum of 14 units are connectable with a single GP-IB card.

Local bus section	
Specifications	Conforms to the RS-485 Standards. Exclusive protocol.
Max. cable length	10 [m]
Connector type	RJ-11 (6-pin modular) Pin 2 (D+), pin 3 (D-)
Applicable cable	Exclusive modular cable CB-0603S, -0615S, -0630S & -06100S
Q'ty of connectable units	Maximum of 10 units are connectable through daisy chain connection.
Terminator	Built-in. May be turned on/off with jumper pin.
Q'ty of ports	2 ports, non-directional

※ The IF-60RU and IF-60GP have the same local bus for the slave units, which may be equipped with either type of interface boards.

8-4. Connection Methods

Refer to the instruction manual supplied with the interface boards for the mounting method in the PSF Series power supply units.

Be sure to confirm that power is off before mounting the interface board for safe operation.

The following shows an example of connecting several PSF Series power supply units through the local buses.

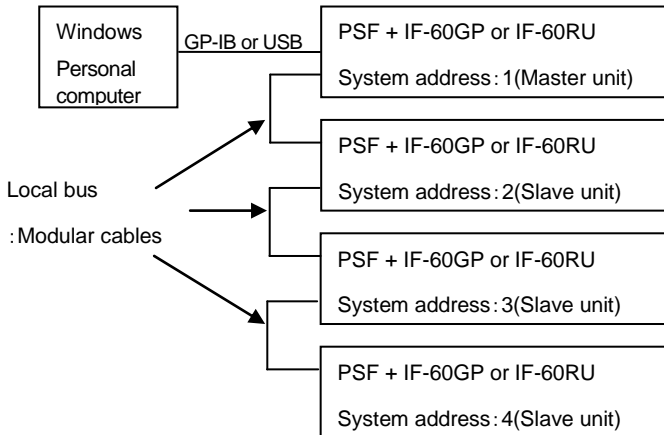

Fig.8-2 Local bus Connection

The input and output of the interface board need not be discriminated for local bus connection.

Use as short modular cables as possible. Short-circuit the jumper pins (CN2) of the interface units at both ends with the shorting connectors ^{※1}. Disconnect the shorting connectors from other interface boards ^{※2}.

^{※1} The interface board is short-circuited with the jumper pin before shipment.

◆ See Fig. 8-1 for the CN2.

^{※2} Keep the disconnected connectors in safe without losing them.

Disconnect the CN2 from the interface board of system addresses 2 and 3 in the example shown in Fig. 8-2.

8-5. Connection cables

- Use the exclusive modular cables for local bus connection.
(Our product Nos.:CB-0603S, CB-0615S, CB-0630S & CB-06100S)
- Use GP-IB cables obtainable on the market for GP-IB connection.
(Our product No.: CB-2420P)
- Use USB cables (applicable to the full speed or superior)
obtainable on the market for USB connection.
- Use interlink cables for Personal computers for RS-232C connection.
The pin assignment is as shown below. Note that the normal cross
cables may not be used.

Personal computer				IF-60RU	
D-Sub 9 pin Male	2	RxD	<—>	3	D-Sub 9 pin Male
	3	TxD	<—>	2	
	4	DTR	<—>	6	
	5	GND	<—>	5	
	6	DSR	<—>	4	Inch screw
	7	RTS	<—>	8	
	8	CTS	<—>	7	
	FG		<—>	FG	

Fig.8-2 RS-232C Cable Connection

8-6. Address Setting

The interface has two addresses: Personal computer address, and system address. It depends on the address whether the unit serves as the master unit connected with a Personal computer or a slave unit connected with the local bus. If the system address of a unit is set to 1, that unit serves as the master unit, whose Personal computer address may be specified. Assign different numbers to all slave units connected with a single master unit.

- ※ **The system address of the unit directly connected with a Personal computer must be 1.**
- ※ **The system operation is not guaranteed if several slave units connected with the master unit have the same system address.**
Do not assign the same address to several slave units.

Address	Range	Remark
System address	1 to 30	Address 1 is used for the master unit. Other addresses are for the slave units. The slave units connected with a single master unit must have different system addresses.
Personal computer address	1 to 30	The Personal computer address may be set only when the system address is 1. It is the GP-IB address for the GP-IB interface. It is a number for equipment specification for the USB interface. RS-232C uses no Personal computer address.

Turn on the unit while holding the **A** key to set the system address and/or Personal computer address. The model name and version data are displayed first, and the interface type is displayed. Then, the system address may be set *1. “Sy.Ad” is displayed on the voltage 7-segment LED, and the address is displayed on the current 7-segment LED. Rotate the encoder to select the proper address, and press the **ENTER / CHECK** key.

The selected system address is validated. A unit whose system address is other than 1 provides normal operation.

*1: Keep the **A** key depressed until “Sy.Ad” is displayed.

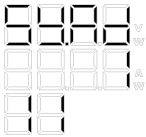

System address 1

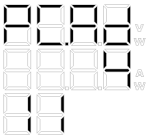

Personal computer address 4

When the system address 1 is set, “PC.Ad” is displayed on the voltage 7-segment LED, indicating that a Personal computer address may be set. Rotate the encoder to select the proper address, and press the **ENTER / CHECK** key. The Personal computer address is validated, and the unit provides normal operation.

The unit stores the system address and Personal computer address, which will remain valid even after power of the unit is turned off until they are changed.

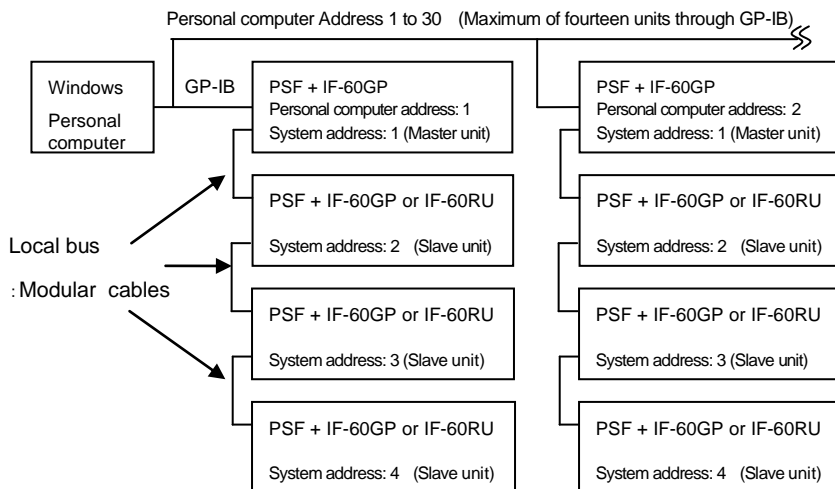

※ Use the IF-60RU in the master unit when the USB interface is

Fig.8-3 Address Setting Example using GP-IB Interface

8-7. Using Interface Boards

8-7-1. Using the GP-IB interface

- We checked GP-IB operations using the NATIONAL INSTRUMENTS interface board and provide sample programs ※¹. All interface boards conforming to the IEEE488 Standards will work free from troubles, and the user may use any board. However, it may take long time to provide support or we cannot take proper actions, depending on the types of interface boards. Please note this.
- The IF-60GP accepts the delimiters LF (0 × 0A), EOI, and LF (0 × 0A) + EOI. It sends a response in LF (0 × 0A) + EOI only.
- When using the local bus through GP-IB, control must be returned to the master unit after transferring commands to the slave units ※². Unless control has been returned to the master unit, the GP-IB tool in the Personal computer may fail to recognize the interface board properly.

※¹ You may download the sample programs from the Texio homepage.
Access to: <http://www.texio.jp>

※² Send ADDR1.

◆ See Section “8-3-37. Local address specification” below.

8-7-2. Using the USB interface

- You may use the USB port of your Personal computer for communication through the USB interface. Microsoft Windows 2000 or later version operating systems may be used.
- To use the USB interface, it is necessary to install the exclusive device driver and API. For the installation procedures, refer to the instruction manual of the API.^{※1}
- This driver does not cover the suspension and sleep functions of the Personal computer. It may fail to demonstrate its full performances when the screen saver or other application is running. Please note this.
- The USB hub is easily affected by external noises, which may cause malfunctioning. Utilize self-powered operation as far as possible so that the communication path is not affected by noises.

※1: You may download the instruction manual of the API from the Texio homepage. Access to: <http://www.texio.jp>

8-7-3. Using the RS-232C interface

You may use the serial port of your Personal computer or sequencer for communication through the RS-232C interface. The RS-232C interface utilizes the CTS-RTS flow for communication control.

If the flow control fails to work properly, some characters may be lost, resulting in malfunctioning. Please note this.

Note that the cross cables for Personal computers use different flow control connection and are unusable.

8-7-4. Using the local bus

The time-out of communication between the Personal computer and master unit should be longer when the local bus is used. The communication time is influenced by the cable length. Check it and determine the time-out value.



CAUTION

General description about communication

When you are going to control several PSF Series power supply units from a Personal computer, the potential of the frames of the power supply units must be equal to that of the Personal computer frame. If those potentials are different, you may receive electric shocks or the Personal computer may be broken.

Be very careful.

8-8. Communication commands

- Every communication command consists of general alphanumeric characters and symbols and has a header, which is the abbreviation of a function. Parameters consist of an integer (NR1) and decimal places (NR2). Parameters following the tenth character are ignored. Decimal places are rounded off according to the actual setting resolution. The response contains no header. Only parameters are sent in response.
- LF (0×0A) is used as the delimiter, which indicates the end of data. Multi-commands consisting of several continuous commands are not applicable to communication of the PSF Series power supply unit. Thus, commands must be separated with delimiters. If delimiters are used, the interface unit automatically controls the flow of communication. Communication commands are accepted, whether they are written in capital letters or small letters.
- Use the address command “:ADDR” to specify a system address of the slave unit when communicating with the slave unit in the local bus from the Personal computer. Since address 1 has been set by default, the system address of the master unit is to be specified.
- A command only applicable to the two-output model (PSF-400L2) causes an error, if it is used for a one-output model (PSF-400L and -800L). If a command is used for either channel, “:A” or “:B” should be added to the command to specify the channel.
- An error occurs if a command causing a competitive operation is sent while the sequence, tracking or external control function is working.

Command List

Category	Set item	Command	Query	Page	Function
Output setting	Output voltage setting	:VOLT	:VOLT ?	P78	P27
	OVP setting	:VOLT:PROT	:VOLT:PROT ?	P78	P33
	Output current setting	:CURR	:CURR ?	P79	P27
	OCP setting	:CURR:PROT	:CURR:PROT ?	P80	P33
	Output power setting	:POW	:POW ?	P81	P27
	Output ON/OFF	:OUTP	:OUTP ?	P82	P28
Function	Hi-QON/OFF	:CONF:HIZ	:CONF:HIZ ?	P82	P34
	Hi-Qtime setting	:CONF:HIZ:HOLD	:CONF:HIZ:HOLD ?	P83	P34
	Display switch	:CONF:DISP	:CONF:DISP ?	P83	P14、29
	Tracking ON/OFF	:CONF:TRAC	:CONF:TRAC ?	P84	P45
External control	External control setting	:EXT:MOD	:EXT:MOD ?	P84	P40,49
	External voltage control	:EXT:VOLT	:EXT:VOLT ?	P85	P40、51
	External current control	:EXT:CURR	:EXT:CURR ?	P85	P41、52
	Output switching	:EXT:OUTP	:EXT:OUTP ?	P86	P42、53
Off timer	Off timer ON/OFF	:TIMER:MOD	:TIMER:MOD ?	P86	P35
	Off timer value setting	:TIMER:SET	:TIMER:SET ?	P87	P35
Delay	Delay ON/OFF	:DELAY:MOD	:DELAY:MOD ?	P87	P43
	Rise delay time	:DELAY:RISE	:DELAY:RISE ?	P88	P43
	Fall delay time	:DELAY:FALL	:DELAY:FALL ?	P88	P43
Status check	Monitor request	-----	:MEAS ?	P88	P50
Preset	Call	:PRES:CALL	:PRES:CALL ?	P89	P32
	Save	:PRES:SAVE	:PRES:SAVE ?	P89	P32
Sequence	Sequence mode setting	:SEQ:MOD	:SEQ:MOD ?	P90	P37
	Jump	:SEQ:STEP	:SEQ:STEP ?	P90	P37、56
	Start step	:SEQ:START	:SEQ:START ?	P90	P37、56
	End step	:SEQ:END	:SEQ:END ?	P91	P37、56
	Repetition frequency	:SEQ:CYCL	:SEQ:CYCL ?	P91	P37、56
	Data transfer	:SEQ:DOWNLOAD	:SEQ:DOWNLOAD ?	P91	P91
Common	Model inquiry	-	* IDN ?	P92	P92
	ESR query	-	* ESR ?	P97	P97
	Event enable	* ESE	* ESE ?	P97	P97
	STB query	-	* STB ?	P96	P96
	SRQ enable	* SRE	* SRE ?	P96	P96
	Clear	* CLS	-	P92	P92
	Reset	* RST	-	P93	P93
	Completion	* OPC	* OPC ?	P93	P93
Wait for completion	* WAI	-	P93	P93	
Extension	Local communication	:ADDR	-	P94	P68
	Remote mode	:REMOTE	:REMOTE ?	P94	P68

◆ See the pages shown in "Function".

8-8-1. Output voltage setting (:VOLT)

This command sets or inquires about the output voltage.

Setting	:VOLT<value> Sets the output voltage of a one-output model. :VOLT:A<value> Sets the output voltage of CHA. :VOLT:B<value> Sets the output voltage of CHB. The <value> range is from 0.00 to 82.00. Two decimal places are valid.
Application example	:VOLT 10.10 Sets the output voltage of a one-output model to 10.10V.
Query	:VOLT? Inquires about the set output voltage of a one-output model. :VOLT:A? Inquires about the set output voltage of CHA. :VOLT:B? Inquires about the set output voltage of CHB.
Response example	10.10 Indicates that the set output voltage is 10.10V.
Remark	In tracking operation, setting of the CHA reflects upon the CHB and CHB setting causes an execution error.

8-8-2. OVP setting (:VOLT:PROT)

This command sets or inquires about the OVP (over-voltage protection) value.

Setting	:VOLT:PROT<value> Sets the OVP value of one-output model. :VOLT:PROT:A<value> Sets the OVP value of CHA. :VOLT:PROT:B<value> Sets the OVP value of CHB. The <value> range is from 1.00 to 84.00. Two decimal places are valid.
Application example	:VOLT:PROT 10.10 Sets the OVP value of a one-output model to 10.10V.
Query	:VOLT:PROT? Inquires about the set OVP value of a one-output model. :VOLT:PROT:A? Inquires about the set OVP value of CHA. :VOLT:PROT:B? Inquires about the set OVP value of CHB.
Response example	10.10 Indicates that the set OVP value is 10.10V.
Remark	None

8-8-3. Output current setting (:CURR)

This command sets or inquires about the output current.

Setting	<p>:CURR <value> Sets the output current of a one-output model.</p> <p>:CURR:A<value> Sets the output current of CHA.</p> <p>:CURR:B<value> Sets the output current of CHB.</p> <p>The <value> range in single-unit operation is as shown below: PSF-400L & PSF-400L2: 0.00 to 41.00 PSF-800L: 0.00 to 82.00</p> <p>Two decimal places are valid. The setting range changes in power extension master-slave (parallel) operation. Resolution in parallel operation: 100mA Setting range: 0.0 to (total current x 1.025)</p>
Application example	<p>:CURR 10.10 Sets the output current of a one-output model to 10.10A.</p>
Query	<p>:CURR? Inquires about the set output current of a one-output model.</p> <p>:CURR:A? Inquires about the set output current of CHA</p> <p>:CURR:B? Inquires about the set output current of CHB.</p>
Response example	<p>10.10 Indicates that the set output current is 10.10A.</p>
Remark	<p>In tracking operation, setting of the CHA reflects upon the CHB and CHB setting causes an execution error.</p>

8-8-4. OCP setting (:CURR:PROT)

This command sets or inquires about the OCP (over-current protection) value.

Setting	<p>:CURR:PROT<value> Sets the OCP value of a one-output model.</p> <p>:CURR:PROT:A<value> Sets the OCP value of CHA.</p> <p>:CURR:PROT:B<value> Sets the OCP value of CHB.</p> <p>The <value> range in single-unit operation is as shown below: PSF-400L & PSF-400L2: 1.00 to 42.00 PSF-800L: 1.00 to 84.00 Two decimal places are valid. The setting range changes in power extension master-slave (parallel) operation. Resolution in parallel operation: 100mA Setting range: 0.0 to (total current x 1.05)</p>
Application example	<p>:CURR:PROT 10.10 Sets the OCP value of a one-output model to 10.10A.</p>
Query	<p>:CURR:PROT? Inquires about the set OCP value of a one-output model.</p> <p>:CURR:PROT:A? Inquires about the set OCP value of CHA.</p> <p>:CURR:PROT:B? Inquires about the set OCP value of CHB.</p>
Response example	<p>10.10 Indicates that the set OCP value is 10.10A.</p>
Remark	<p>In tracking operation, setting of the CHA reflects upon the CHB and CHB setting causes an execution error.</p>

8-8-5. Output power setting (: POW)

This command sets or inquires about the output power.

Setting	<p>: POW <value> Sets the output power of a one-output model.</p> <p>: POW : A<value> Sets the output power of CHA.</p> <p>: POW : B<value> Sets the output power of CHB.</p> <p>The <value> range in single-unit operation is as shown below: PSF-400L & PSF-400L2: 10 to 410 PSF-800L: 10 to 820</p> <p>The integer is valid.</p> <p>The setting range changes in power extension master-slave (parallel) operation. Setting range: 0.0 to (total power x 1.025)</p>
Application example	<p>: POW 100 Sets the output power of a one-output model to 100W.</p>
Query	<p>: POW? Inquires about the set output power of a one-output model.</p> <p>: POW : A? Inquires about the set output power of CHA.</p> <p>: POW : B? Inquires about the set output power of CHB.</p>
Response example	<p>100 Indicates that the set output power is 100W.</p>
Remark	<p>In tracking operation, setting of the CHA reflects upon the CHB and CHB setting causes an execution error.</p>

8-8-6. OUTPUT ON/OFF (:OUTPUT)

This command turns on or off output.

Setting	:OUTPUT <value> Sets the output of a one-output model. :OUTPUT:A<value> Sets the output of CHA. :OUTPUT:B<value> Sets the output of CHB. The relationship between <value> and On/Off is as shown below: 1: Output On, 0: Output Off On the two-output mode, :OUTPUT selects the OUTPUT key. Output is activated only after <value> is set to 1.
Application example	:OUTPUT 1 Activates output.
Query	:OUTPUT? Inquires about the output setting of a one-output model. :OUTPUT:A? Inquires about the output setting of CHA. :OUTPUT:B? Inquires about the output setting of CHB.
Response example	1 Indicates that output is activated. "?" has the same function as <value>
Remark	This command causes an execution error if output is to be set externally. Sending the :OUTPUT command causes a command error when both channels of the two-output model are deactivated.

8-8-7. Hi-ΩON/OFF (:CONF:HIZ)

This command turns on or off the Hi-Ωfunction.

Setting	:CONF:HIZ <value> <value> is as shown below: 1: Hi-ΩOn 0: Hi-ΩOff
Application example	:CONF:HIZ 1 Activates the Hi-Ωfunction.
Query	:CONF:HIZ? Inquires about the setting.
Response example	1 Indicates that the Hi-Ωfunction is working. "?" has the same function as <value>.
Remark	None

8-8-8. Hi-Ωtime setting (:CONF:HIZ:HOLD)

This command sets the Hi-Ωfunction holding time in minutes.

Setting	:CONF:HIZ:HOLD <value> <value> is set in 5 steps between 5 and 30. Any value not ending with 0 or 5 is rounded off.
Application example	:CONF:HIZ:HOLD20 Sets the Hi-Ωholding time to 20 minutes.
Query	:CONF:HIZ:HOLD? Inquires about the setting.
Response example	5 Indicates that the Hi-Ωholding time is five minutes. "?" has the same function as <value>.
Remark	None

8-8-9. Display switching (:CONF:DISP)

This command switches the voltage, current and power display modes.

Setting	:CONF:DISP <value> <value> is as shown below: 1: CHA voltage + current display 2: CHA voltage + power display 3: CHA power + current display 4: CHB voltage + current display 5: CHB voltage + power display 6: CHB power + current display 7: Sequence or Off Timer display For a one-output model, use the values 1 to 3 or 7 to specify a display mode.
Application example	:CONF:DISP 1 Selects the voltage + current display mode.
Query	:CONF:DISP? Inquires about the display setting.
Response example	1 Indicates that the voltage + current display mode is selected. "?" has the same function as <value>.
Remark	A value between 4 and 6 causes an error if it is set for a one-output model. The value of 7 causes an error unless the Off Timer or sequence function (Pause, RUN) is working.

8-8-10. Tracking ON/OFF (:CONF:TRAC)

This command turns on or off the tracking function.

Setting	:CONF:TRAC <value> <value> is as shown below: 0: Off 1: On
Application example	:CONF:TRAC 1 Activates the tracking function.
Query	:CONF:TRAC? Inquires about the setting.
Response example	1 Indicates that the tracking function is working. "?" has the same function as <value>.
Remark	This command causes an error if it is set for a one-output model or during sequence operation (RUN).

8-8-11. External control setting (:EXT:MOD)

This command sets an external control mode.

Setting	:EXT:MOD <value> <value> is as shown below: 0: Setting from the panel or through communication 1: External control with voltage 2: External control with resistance
Application example	:EXT:MOD 1 Selects the external control with voltage.
Query	:EXT:MOD? Inquires about the setting.
Response example	1 Indicates that external control with voltage is working. "?" has the same function as <value>.
Remark	This command causes an error during sequence operation (RUN).

8-8-12. External output voltage control ON/OFF (:EXT:VOLT)

This command selects the external output voltage control mode.

Setting	:EXT:VOLT <value> Activates or deactivates external output voltage control of a one-output model. :EXT:VOLT:A<value> Activates or deactivates external output voltage control of CHA. :EXT:VOLT:B<value> Activates or deactivates external output voltage control of CHB. <value> is as shown below: 0: Deactivates external output voltage control (for control from the panel or through communication). 1: Activates external output voltage control.
Application example	:EXT:VOLT 1 Selects the external output voltage control.
Query	:EXT:VOLT? Inquires about the setting.
Response example	1 Indicates that external output voltage control is working. “?” has the same function as <value>.
Remark	This command causes an error during sequence operation (RUN).

8-8-13. External output current control ON/OFF (:EXT:CURR)

This command selects the external output current control mode.

Setting	:EXT:CURR <value> Activates or deactivates external output current control of a one-output model. :EXT:CURR:A <value> Activates or deactivates external output current control of CHA. :EXT:CURR:B <value> Activates or deactivates external output current control of CHB. <value> is as shown below: 0: Deactivates external output current control (for control from the panel or through communication). 1: Activates external output current control.
Application example	:EXT:CURR 1 Selects the external output current control.
Query	:EXT:CURR? Inquires about the setting.
Response example	1 Indicates that external output current control is working. “?” has the same function as <value>.
Remark	This command causes an error during sequence operation (RUN).

8-8-14. Output switching (:EXT:OUTP)

This command selects output On/Off with external contacts.

Setting	:EXT:OUTP <value> <value> is as shown below: 0: Control from the panel or through communication 1: Output On/Off with external contacts
Application example	:EXT:OUTP 1 Selects output On/Off with external contacts.
Query	:EXT:OUTP? Inquires about the setting.
Response example	1 Indicates that output On/Off with external contacts is working. "?" has the same function as <value>.
Remark	This command causes an error during sequence operation (RUN).

8-8-15. Off timer ON/OFF (:TIMER:MOD)

This command activates or deactivates the Off Timer.

Setting	:TIMER:MOD <value> <value> is as shown below: 0: Deactivates the Off Timer. 1: Activates the Off Timer.
Application example	:TIMER:MOD 1 Activates the Off Timer.
Query	:TIMER:MOD? Inquires about the setting.
Response example	1 Indicates that the Off Timer is working. "?" has the same function as <value>.
Remark	This command causes an error during sequence operation (RUN).

8-8-16. Off timer value setting (:TIMER:SET)

This command sets or inquires about the Off Timer value.

Setting	:TIMER:SET <value> The <value> range is between 0.1 and 99.5. Specify the hour in the integer part and minutes in the first decimal place (in units of 10 minutes).
Application example	:TIMER:SET 10.3 Set the Off Timer value to 10 hours and 30 minutes.
Query	:TIMER:SET? Inquires about the setting.
Response example	15.2 Indicates that the Off Timer value is set to 15 hours and 20 minutes.
Remark	This command causes an error during sequence operation (RUN). It also causes an error if a value between 6 and 9 is set in the first decimal place.

8-8-17. Delay function ON/OFF (:DELAY:MOD)

This command activates or deactivates the delay function.

Setting	:DELAY:MOD <value> <value> is as shown below: 0: Deactivates the delay function. (Normal) 1: Activates the delay function.
Application example	:DELAY:MOD 1 Activates the delay function.
Query	:DELAY:MOD? Inquires about the setting.
Response example	1 Indicates that the delay function is working. "?" has the same function as <value>.
Remark	This command causes an error during sequence operation (RUN).

8-8-18. Delay rise time setting (:DELAY:RISE)

This command sets or inquires about the delay time for turning on output.

Setting	:DELAY:RISE <value> The <value> range is from -9.99 to +10.00 in units of seconds.
Application example	:DELAY:RISE 0.3 Sets the delay time for turning on output to 0.3 second.
Query	:DELAY:RISE? Inquires about the setting.
Response example	0.3 Indicates that the delay time for turning on output is set to 0.3 second.
Remark	This command causes an error during sequence operation (RUN).

8-8-19. Delay fall time setting (:DELAY:FALL)

This command sets or inquires about the delay time for turning off output.

Setting	:DELAY:FALL <value> The <value> range is from -9.99 to +10.00 in units of seconds.
Application example	:DELAY:FALL 0.3 Sets the delay time for turning off output to 0.3 second.
Query	:DELAY:FALL? Inquires about the setting.
Response example	0.3 Indicates that the delay time for turning off output is set to 0.3 second.
Remark	This command causes an error during sequence operation (RUN).

8-8-20. Monitor inquiry (:MEAS?)

This command inquires about the monitored data. In response, the voltage, current, power and CV/CC/CP status are returned.

Setting	None
Query	:MEAS? Inquires about the monitored data of the one-output model. :MEAS:A? Inquires about the monitored data of the CHA. :MEAS:B? Inquires about the monitored data of the CHB.
Response example	20.00,5.00,100,0 Indicates that the output values are 20.00V, 5.00A and 100W and the CV function is working. ※ The voltage, current, power and status are returned in this order. The status is 0 (CV), 1 (CC) or 2 (CP).
Remark	None

8-8-21. Preset calling (:PRES:CALL)

This command calls and inquires about preset data.

Setting	:PRES:CALL <value> <value> is as shown below: 0: Cancels preset. 1: Calls PRESET 1 data. 2: Calls PRESET 2 data. 3: Calls PRESET 3 data.
Application example	:PRES:CALL1 Calls the set values stored in PRESET 1.
Query	:PRES:CALL? Inquires about the setting.
Response example	1 Indicates that PRESET 1 is selected. "?" has the same function as <value>
Remark	This command causes an error during sequence operation (RUN).

8-8-22. Preset saving (:PRES:SAVE)

This command saves the current set values (voltage, current and power) in PRESET memory.

Setting	:PRES:SAVE <value> <value> is as shown below: 1: Saves the current set value in PRESET 1. 2: Saves the current set value in PRESET 2. 3: Saves the current set value in PRESET 3.
Application example	:PRES:SAVE1 Saves the current set values in PRESET 1.
Query	None
Remark	This command causes an error during sequence operation (RUN).

8-8-23. Sequence mode setting (:SEQ:MOD)

This command sets sequence mode operation.

Setting	:SEQ:MOD <value> <value> is as shown below: 0: Stops sequence operation. 1: Sequence operation – Waits for starting (PAUSE). 2: Sequence operation – Executes (RUN).
Application example	:SEQ:MOD 2 Executes sequence operation.
Query	:SEQ:MOD? Inquires about the setting.
Response example	2 Indicates that sequence operation is being executed. “?” has the same function as <value>
Remark	None

8-8-24. Sequence jump setting (:SEQ:STEP)

This command jumps to a specified step of sequence operation.

Setting	:SEQ:STEP <value> The <value> range is from 0 to 99. This command is accepted in the wait-for-sequence status (PAUSE) only.
Application example	:SEQ:STEP 2 Changes the sequence step No. into 2.
Query	:SEQ:STEP? Inquires about the setting.
Response example	2,1 Indicates that step 2 is selected and the repetition frequency is 1.
Remark	This command causes an error during sequence operation (RUN).

8-8-25. Sequence start step setting (:SEQ:START)

This command specifies a start step of sequence operation.

Setting	:SEQ:START<value> The <value> range is from 0 to 99.
Application example	:SEQ:START2 Sets the sequence start step No. to 2.
Query	:SEQ:START? Inquires about the setting.
Response example	2 Indicates that sequence operation starts from step 2.
Remark	None

8-8-26. Sequencer end step setting (: SEQ:END)

This command specifies an end step of sequence operation.

Setting	: SEQ:END<value> The <value> range is from 0 to 99.
Application example	: SEQ:END2 Sets the sequence end step No. to 2.
Query	: SEQ:END? Inquires about the setting.
Response example	2 Indicates that sequence operation ends at step 2.
Remark	None

8-8-27. Sequence repetition frequency setting (: SEQ:CYCL)

This command specifies the frequency (number of times) of repeating sequence operation.

Setting	: SEQ:CYCL<value> The <value> range is from 0 to 999. When 0 is set, sequence operation is repeated endlessly.
Application example	: SEQ:CYCL 2 Sets the sequence repetition frequency to 2.
Query	: SEQ:CYCL? Inquires about the setting.
Response example	2 Indicates that sequence operation is repeated twice.
Remark	None

8-8-28. Sequence data transfer (: SEQ:DOWNLOAD)

This command transfers the sequence set data.

Setting	: SEQ:DOWNLOAD<value> <value> represents 1609-byte binary sequence set data.
Application example	: SE:DOWNLOAD#6001600······LF Transfers the 8-byte header of the binary data, 1600-byte actual data, and delimiter data in sequence.
Query	: SEQ:DOWNLOAD? Requests the sequence data.
Response example	#6001600······LF 1609-byte sequence set data are returned.
Remark	Exclusive application software is available. Use it for setting ※ ¹

※¹ The application software exclusive for sequence operation may be downloaded from our homepage

8-8-29. Model inquiry (*IDN?)

This command inquires about the model.

Setting	None. Query only.
Query	* IDN? The company name, model name, serial number and version are returned in this order.
Response example	TEXIO,PSF-400L,0,1.00/1.00 The serial number is fixed to 0. The version data include the hardware and software versions.

8-8-30. Event register inquiry (*ESR?)

The function of this command is described in “Event register” in the following section.

8-8-31. Event enable register setting (*ESE)

The function of this command is described in “Event register” in the following section.

8-8-32. Status byte inquiry (*STB?)

The function of this command is described in “Status register” in the following section.

8-8-33. SRQ enable register setting (*SRE)

The function of this command is described in “Status register” in the following section.

8-8-34. Buffer clear (*CLS)

This command clears the buffers.

Setting	* CLS Clears the send buffer, receive buffer, local bus buffer, command execution buffer, status byte and event register.
Query	None

8-8-35. Communication reset (*RST)

This command clears the communication status.

Setting	* RST Clears the send buffer, receive buffer, local bus buffer, command execution buffer, status byte and event register. Clears the ESE register and SRE register and also clears the talker and listener setting.
Query	None

8-8-36. Command completion (*OPC)

This command notifies of command execution.

Setting	* OPC Bits 0 of the event status registers are set when the command is executed. SRQ is generated depending on the status of the ESE register and SRE register.
Query	* OPC? The value "1" is returned when the command is executed.

8-8-37. Wait for completion (*WAI)

This command waits for command completion.

Setting	* WAI Waits for execution of the following message till completion of the command: This unit accepts overlap commands only. Executes no processing, in particular.
Query	None

8-8-38. Local address setting (:ADDR)

This command specifies the address of a slave unit on the local bus.

Setting	:ADDR<value> The <value> range is from 1 to 30. Specifies the address of a slave on the local bus to be controlled. This command causes no error even if a non-existing system address is specified.
Application example	:ADDR3 Sets communication with the power supply unit of system address 3. :ADDR1 Sets communication with the power supply unit of system address 1 (master unit).
Query	None
Remark	The default value is 1 (master unit). Reset <value> to 1 after completion of communication with the local bus.

8-8-39. Remote/local setting (:REMOTE)

This command sets or inquires about the remote/local status.

Setting	:REMOTE<value> <value> is as shown below: 0: Local status (Normal manual operation) 1: Remote status 2: Local lockout remote status (Cannot return to the local status through key operation.)
Application example	:REMOTE0 Sets the local status.
Query	:REMOTE?
Response example	1 Indicates that the unit is in the remote status. "?" has the same function as <value>
Remark	If this request is sent in the local status, a response is made after the unit enters the remote status. Thus, 1 is returned.

8-9. Registers

The PSF power supply unit has registers that conform to the status reporting specified in IEEE488.2.

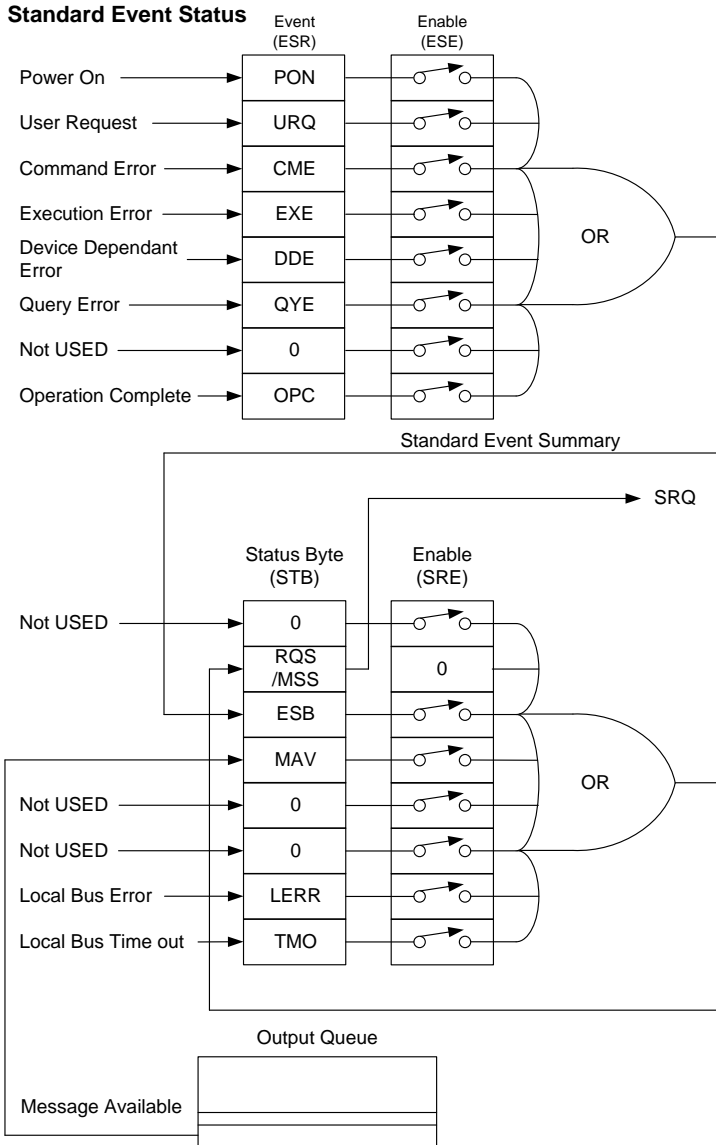

8-9-1. Status register (STB, SRE)

bit	Data	Item	Description	Initial STB value	Initial SRE value
7	128	0	Unused.	0	0
6	64	SRQ RQS MSS	Service request Message summary	0	0
5	32	ESB	Standard event summary	0	0
4	16	MAV	Output message available	0	0
3	8	0	Unused.	0	0
2	4	0	Unused.	0	0
1	2	LERR	Local bus error	0	0
0	1	TMO	Local bus Time out	0	0

Each bit is masked when “0” is set in it. (It is the default setting.)
Masking is canceled when “1” is set. Set “0” in the unused bits.

Item	Description	
SRQ RQS MSS	MSS is set to 1 when AND of the bits of the status byte, excluding this bit (bit 6), and the service request enable register is 1. RQS is set to 1 when MSS changes from 0 into 1. It is cleared when MSS is cleared or serial polling is executed.	
ESB	Indicates that an event occurs in the standard event status register.	
MAV	Indicates that there is a message in the output queue.	
* SRE?	Sets or inquires about the service request enable register.	
	Setting command	* SRE<value> The <value> range is from 0 to 255.
	Application example	* SRE48 MAV and ESB are enabled since the value is 48 (→ 00110000 in binary).
	Query command	* SRE?
	Response example	48 Masking set with this command remains valid until the setting is changed or power is turned off. All bits are masked (0) when power is turned on, regardless of the previous setting.
* STB ?	Reads out the status byte and MSS.	
	Setting command	None. Query only.
	Query command	* STB?
	Response example	32 The bits set with the *SRE command are only returned in decimal. The status byte register is not cleared even if an inquiry is made using this command.

8-9-2. Event register (ESR, ESE)

The event register is controlled with the *ESE, *ESE?, *ESR?

bit	Data	Item	Description	Initial ESR value	Initial ESE value
7	128	PON	Power On flag	1 (Power ON)	0
6	64	-	Unused.	0	0
5	32	CME	Command error	0	0
4	16	EXE	Execution error	0	0
3	8	ALM	Alarm occurrence	0	0
2	4	-	Unused.	0	0
1	2	-	Unused.	0	0
0	1	OPC	Operation complete	0	0

Item	Description	
* ESE	Sets or inquires about the standard event status enable register.	
	Setting command	* ESE<value> The <value> range is from 0 to 255.
	Application example	* ESE48 CME and EXE are enabled.
	Query command	* ESE?
	Response example	48 Masking set with this command remains valid until the setting is changed or power is turned off. All bits are masked (0) when power is turned on, regardless of the previous setting.
* ESR ?	Inquires about the standard event status.	
	Setting command	None. Query only.
	Query command	* ESR?
	Response example	32 A command error takes place. ESR is cleared after reading the value.

8-9-3. function of the status byte

If some event occurs and some bit of the status byte is set to 1, bit 6 is set to 1 and a service request (SRQ) is issued. Four status bits shown below may possibly be the causes of an SRQ in the PSF Series power supply unit.

Bit 5	ESB	Standard event status register summary
Bit 4	MAV	Message available
Bit 1	LERR	Local bus execution error
Bit 0	TMO	Local bus time-out

If an execution error occurs, bit 4 of the standard event status register (ESR) is set to 1. When AND of the ESR and standard event status enable register (ESE) is 1, bit 5 (ESB) of the status byte is set to 1. If bit 5 of the service request enable register (SRE) is 1 at this time, bit 6 (MSS) of the status byte is set to 1 and a service request (SRQ) is sent to the controller.

NOTE: An SRQ is issued through the GP-IB interface only.

8-9-4. Reading data from the status byte and clearing the status byte

Data of the status byte may be read out from the controller in the following two ways:

- Inquiry with the *STB? query
When an inquiry is made with the *STB? query, MSS is read out of bit 6. No bits of the status byte are cleared after reading it.
- Serial polling
When serial polling is executed, RQS is read out of bit 6. RQS is only cleared after reading it. It is impossible to read MSS. It is impossible to clear the status byte directly. It is necessary to clear the event register or the like that is the cause of the status byte.
- When ESB occurs
When an inquiry is made with *ESR?, data of the standard event register are read out and all bits are cleared then.
- When the *CLS command is received.
When receiving the *CLS command, the PSF Series power supply unit clears the standard event register and status byte.
- When MAV occurs
The MAV bit is cleared when data are read out from the output queue completely.
The output queue is not cleared by the *CLS command.
When the event register and MAV are cleared completely, MSS in bit 6 is also cleared.

8-9-5. Clear and reset statuses

It is possible to cause clearing or resetting in the PSF Series power supply unit by issuing commands or executing specific operations.

■ IFC (Interface clear)

Responses to the universal command IFC are as shown below:

- The specified talker or listener status is cleared.
- The GP-IB buffer, output queue and standing-by command remain unchanged.
- The SRQ remains unchanged.
- The remote status and LLO setting remain unchanged.
- Panel setting remains unchanged.

■ DCL SDC (Device clear)

Responses to the universal command DCL and address command SDC are as shown below:

- The GP-IB buffer, output queue and standing-by command are cleared.
- The interface status (specified talker or listener status) is cleared.
- The SRQ and status byte are cleared.
- The remote status and LLO setting are cleared and the power supply unit enters the local state.
- Panel setting remains unchanged.

■ *RST (Reset command)

Responses to the IEEE488.2 command *RST are as shown below:

- The specified talker or listener status is cleared.
- The GP-IB buffer, output queue and standing-by command are cleared.
- The SRQ, status byte and mask setting are cleared.
- The remote status and LLO setting remain unchanged.
- Panel setting remains unchanged.

■ Turning on power again

When power is turned on again, the statuses are as shown below:

- The specified talker or listener status is cleared.
- The GP-IB buffer, output queue and standing-by command are cleared.
- The SRQ, status byte and mask setting are cleared.
- The unit enters the local status.
LLO set before turning off power is cleared.
- Panel setting at the time when power is turned off remains unchanged.

8-9-6. Remote/local function

The remote/local function is controlled by the system controller and with the **FAST** key of the PSF Series power supply unit. (This key serves as the FAST, LOCK and LOCAL keys.) The PSF Series power supply unit always resides in the local, remote, or remote with local lockout status.

■ Local

The PSF Series power supply unit enters the local status in either of the following cases:

- When power is turned on.
- When the **FAST** key is pressed and the LED on the side of key.
- When the unit receives the GTL command.
- When the remote status is canceled.

■ Remote

The PSF Series power supply unit enters the remote status when it is specified as the listener in the condition where REN is true. The LED enters the remote display mode, where any other panel keys than the POWER switch and **FAST** key are inoperative. In the local lockout status, any other keys than the POWER switch are inoperative, with the only exception of an error.

8-9-7. Responses to multi-line message commands

The table below shows the types of multi-line message commands and the responses to the commands.

Type	Name	Description	Response
Universal commands	DCL	Clears the GP-IB buffer.	○
	SPE	Establishes the serial polling state.	○
	SPD	Clears serial polling.	○
	PPU	Clears parallel polling.	×
	LLO	Brings all devices into the local lockout status to disable manual operation.	○
Address commands	UNL	Cancels the specified listener status.	○
	UNT	Cancels the specified talker status.	○
	SDC	Clears the GP-IB buffer.	○
	PPC	Enables parallel polling line assignment to the specified listener in parallel polling.	×
	GTL	Brings a specified device into the local status.	○
	GET	Triggers a specified device.	×
	TCT	Transfers the controller.	×

9. TROUBLESHOOTING

This section shows the typical phenomena that imply troubles. Some phenomena may be solved by rechecking or in simple manner. Contact the nearest our distributor for phenomena that rechecking or countermeasures may not eliminate or improve. Never detach the case to check the inside.

Phenomenon	Possible cause	Check & countermeasures
Power is not turned on even by throwing the POWER switch.	• AC power cable is broken or has poor contact.	• Check connection or replace the cable.
	• Input fuse has blown.	• Input voltage is out of the allowable range.
“----” is displayed after starting operation.	The unit is specified as a slave unit.	Specify the unit as the master unit. See Section “5-5-10. Master/slave function”.
“OHP” is displayed after starting operation.	The OHP function works.	Check the ambient temperature, air intake and exhaust ports and dust filter.
Display disappears in short time after starting operation.	The fan is stopping.	Check the fan.
No output is given even when the OUTPUT key is pressed.	• The set voltage is “0V”.	• See Section “5-4-1. How to set voltage”. See Section “5-7-2. Constant-voltage control with external voltage or resistance”.
	• The set current is “0A”. (In the CC status)	• See Section “5-4-2. How to set current”. See Section “5-7-3. Constant-current control with external voltage or resistance.”
	• On/Off with the external contacts is selected.	• See Section “5-7-4. Output On/Off with external contacts”.
	• The channel output key is not selected or an incorrect channel is selected for output.	• See Section “5-4-5. How to output”.
	• Keys are locked.	• See Section “5-4-8. How to invalidate on-panel operations”.
“OVP” is displayed when the OUTPUT key is pressed.	• The OVP value is too low.	• See Section “5-5-2. OVP/OCP function”.
	• The sensing wire(s) is/are disconnected.	• See Section “5-6. Voltage Remote Sensing”.
	• The resistor is open in the external resistance control mode.	• See Section “5-7-2. Constant-voltage control with external voltage or resistance”.
“OCP” is displayed when the OUTPUT key is pressed.	• The OCP value is too low.	See Section “5-5-2. OVP/OCP function”.
Cannot raise the current up to the set current value.	CP (constant-power) operation is carried out, or the CP value is too low.	See Section “5-4-3. How to set power”.
Output is unstable.	Oscillating due to influences of the load.	• Twist the load or sensing wires, or change the wire layout. • Connect a capacitor at the output end of the power source or the load end.
Output voltage does not fall.	The Hi- Ω function is activated.	See Section “5-5-3. Hi- Ω function”.

10. MAINTENANCE

The PSF Series power supply unit employs a fan for forced cooling. Clean the dust filter inside the front grill periodically to maintain the cooling efficiency. Pull the front grill while pressing the notch in the upper part to detach the grill. Clean the filter with water. Before starting cleaning, shut off the POWER switch without fail and disconnect the AC power cable to turn off the unit.

⚠ CAUTION
Dry the filter completely before attaching it.
Water remaining in the filter may cause troubles.

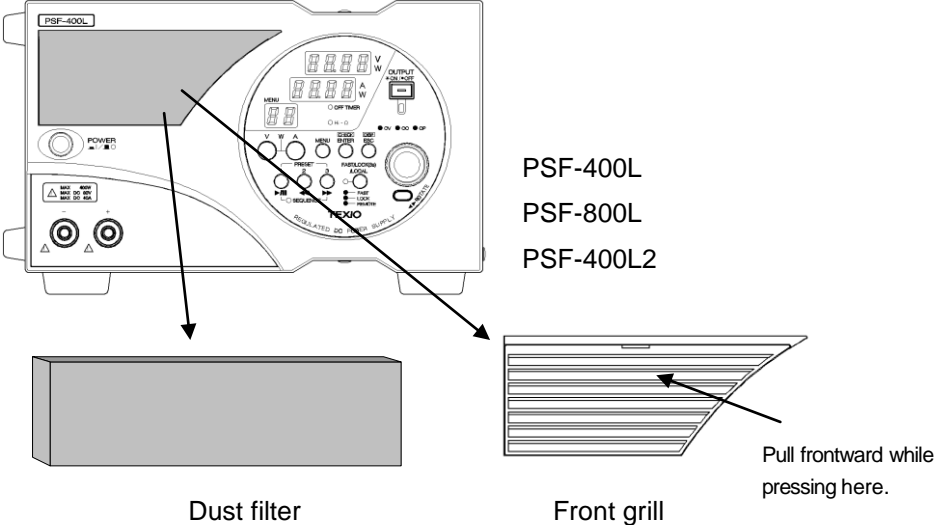

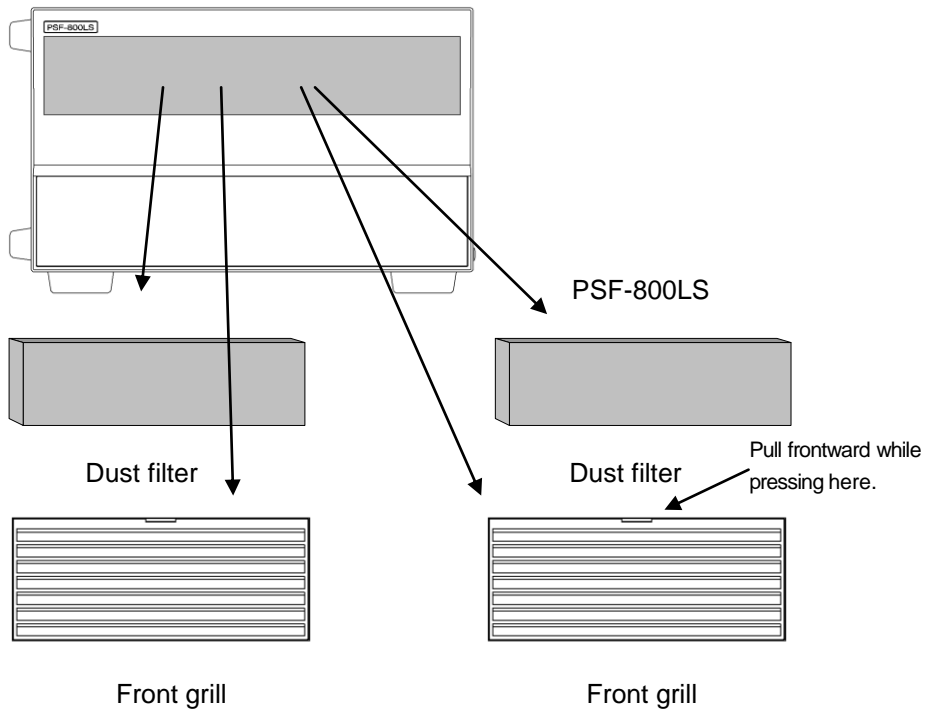

11. OUTSIDE DIMENSIONS

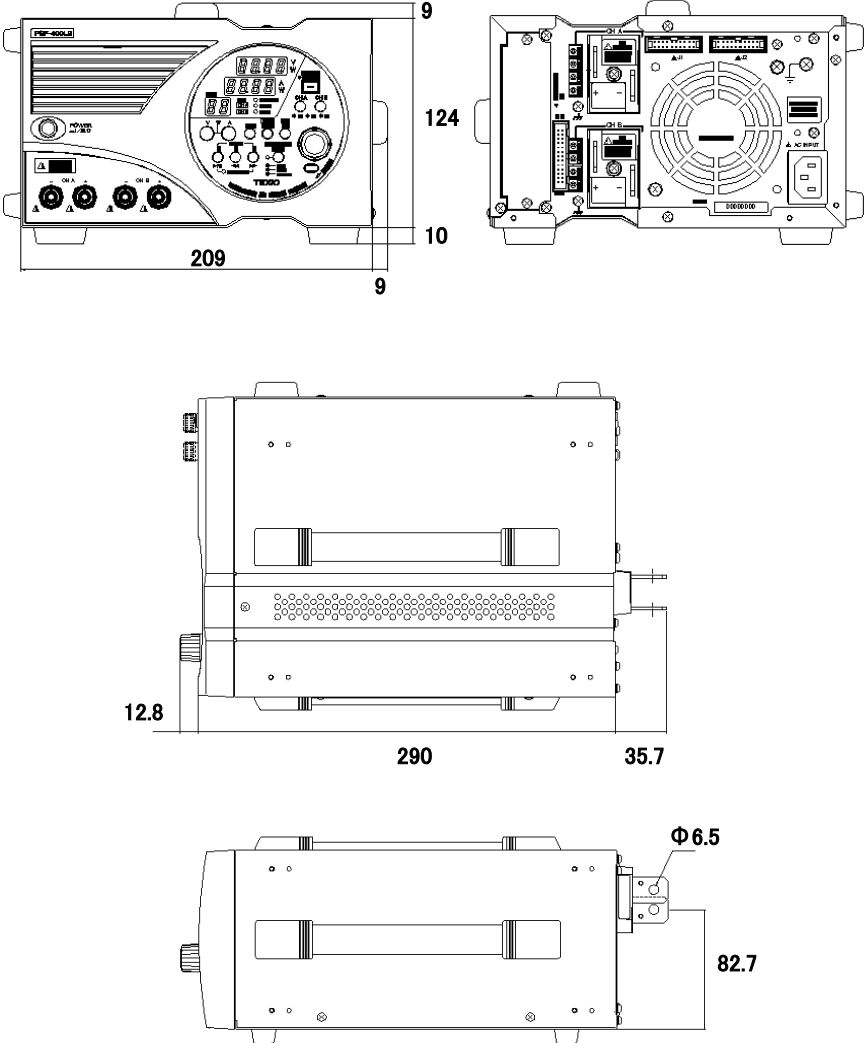

※ The handle is available by option

Fig11-1 Outside Dimensions of PSF-400L、PSF-800L and PSF400-L2

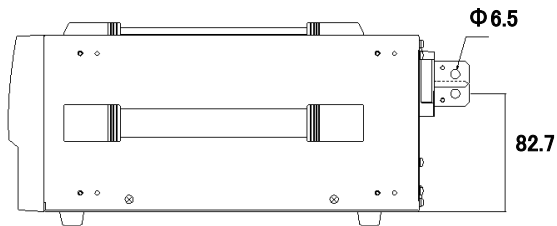
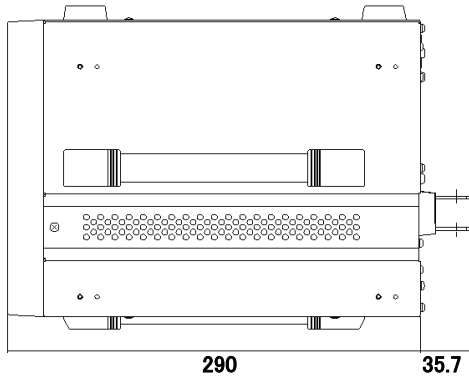
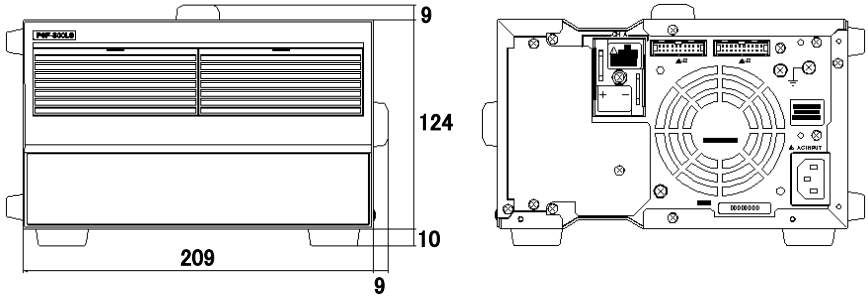

※ The handle is available by option

Fig.11-2 Outside Dimensions of PSF-800LS

12. Specification of PSF-1200L/1600L

Output Specifications

Model		PSF-1200L (400L+800LS)	PSF-1600L (800L+800LS)
Voltage	Rated output voltage	80.00V	
	Setting accuracy	0.1%setting±2digit (23°C±5°C)	
	Resolution	10mV	
	Display accuracy	0.2%reading±2digit (23°C±5°C)	
Current	Rated output current ※ ¹	120.0A	160.0A
	Setting accuracy	1A-Max: 0.2%setting±2digit 0A - 1A : ±5digit (23°C±5°C)	
	Resolution	90mA(※ ²)	100mA
	Display accuracy	0.3%reading±2digit (23°C±5°C)	
Power	Rated output power ※ ²	1200W	1600W
	Setting accuracy	0A -1A : ±30W / 1A - Max: ±20W	
	Resolution	99W	100W
	Display accuracy	0.5%reading±5digit (23°C±5°C)	

NOTES

※¹ : The maximum output current through the front output terminals is 40A.

※² : Switching from the constant-voltage (CV) or constant-current (CC) mode into the constant-power (CP) mode or vice versa is subject to over-shoot ringing, etc.

Input Specifications

Model	PSF-1200L	PSF-1600L
Input voltage	AC100V to 240V, single-phase, frequency: 50Hz or 60Hz	
Power consumption ※ ³	560VA + 1120VA	1120VA + 1120VA
Power factor ※ ⁴	0.99	
Rush current	35Amax. + 70Amax.	70Amax. + 70Amax.

NOTES

※³, 4: At the rated output voltage and AC100V input

Constant-Voltage Characteristics

	PSF-1200L	PSF-1600L
Source fluctuation ※5	0.01% ±2mV of rated voltage	
Load fluctuation ※6	0.01% ±3mV of rated voltage	
Ripple noise (p-p) ※7	150mV	
Ripple noise (rms) ※8	6mV	
Transient response (typ.) ※9	2ms	
Rise time (typ.) ※10	50ms (rated load), 50ms (no load)	
Fall time (typ.) ※11	100ms (rated load) 5000ms (no load)	100ms (rated load) 2000ms (no load)
Temperature coefficient (typ.) ※12	±50ppm/°C (after 30-minute warming up)	

Constant-Current Characteristics

	PSF-1200L	PSF-1600L
Source fluctuation ※5	0.01% ±2mA of rated current	
Load fluctuation ※13	0.02% ±3mA of rated current	
Ripple noise (rms)	120mA	
Temperature coefficient (typ.) ※12	±100ppm/°C (after 30-minute warming up)	

Constant-Power Characteristics

	PSF-1200L	PSF-1600L
Source fluctuation ※5	0.5%±10W	

NOTES

- ※5: Fluctuation when the source voltage is changed by ±10% in the range from AC100V to 240V.
- ※6: Fluctuation when the load is changed from the rated load into no load (open circuit) at the rated output voltage.
- ※7: Measured at the frequency up to 20 MHz.
- ※8: Measured at the frequency up to 1 MHz.
- ※9: Response time till the output voltage is restored to the range within 0.1% + 10 mV of the rated output voltage when the output current is changed from 50% to 100% of the maximum output current at the rated output voltage.
- ※10: Value with a fixed load.
Time until the output voltage increases up to 10% to 90% of the rated output voltage.
- ※11: Value with a fixed load.
Time until the output voltage decreases down to 90% to 10% of the rated output voltage.
- ※12: Value after 30 minutes of warming up (excluding external control).
- ※13: Fluctuation when the load is changed from the rated load into no load (short circuit) at the rated output current.

Functions

Constant-voltage (CV) control with external voltage	Output voltage: Approx. 0V to 80V for external voltage: 0V to 10V
Constant-voltage (CC) control with external resistance	Output voltage: Approx. 0V to 80V for external resistance: 0Ω to 10kΩ
Constant-current (CC) control with external voltage	Output current: Approx. 0A to 120A (1200L) or 0A to 160A (1600L) for external voltage: 0V to 10V
Constant-current (CC) control with external resistance	Output current: Approx. 0A to 120A (1200L) or 0A to 160A (1600L) for external resistance: 0Ω to 10kΩ

Protective functions

Over-voltage protection (OVP): Fixed ※15	Output Off when output voltage exceeds 110% of rated voltage.
Over-voltage protection (OVP): Variable ※16	Pre-settable in range from 1V to 84V on front panel. Output Off when OVP works.
Over-current protection (OCP): Fixed ※15	Output Off when output current exceeds 110% of rated current.
Over-current protection (OCP): Variable ※16	Pre-settable in range from 3A - 126A(1200L) / 2A - 168A(1600L) on front panel. Output Off when OCP works.
Overheat protection (OHP) ※15	Output Off at the internal heat sink temperature over the set temperature.

NOTES

※15: Throw the POWER switch again to reset.

※16: Throw the POWER switch again or press the ESC key to reset.

Applicable Standards

The PSF-1200L / 1600L does not apply CE/LVD/EMC standards.

Others

Outside dimensions (Projections not included.)	420mm(W) × 124mm(H) × 290mm(D)
Weight	PSF-1200L: Approx. 12kg PSF-1600L: Approx. 14kg



TEXIO TECHNOLOGY CORPORATION

7F Towa Fudosan Shin Yokohama Bldg.
2-18-13, Shin Yokohama, Kohoku-ku, Yokohama, Kanagawa, 222-0033 Japan
<http://www.texio.co.jp/>
