

INSTRUCTION MANUAL

MULTI RANGE DC POWER SUPPLY PSW SERIES

PSW-360L30

PSW-720L30

PSW-1080L30

PSW-360L80

PSW-720L80

PSW-1080L80

PSW-360M160

PSW-720M160

PSW-1080M160

PSW-360M250

PSW-720M250

PSW-1080M250

PSW-360H800

PSW-720H800

PSW-1080H800



■ **About Brands and Trademarks**

“TEXIO” is the product brand name of our industrial electronic devices.

All company names and product names mentioned in this manual are the trademark or the registered trademark of each company or group in each country and region.

■ **About the Instruction Manual**

Permission from the copyright holder is needed to reprint the contents of this manual, in whole or in part. Be aware that the product specifications and the contents of this manual are subject to change for the purpose of improvement.

■ **About firmware version**

This programming manual is required firmware version 2.25 or higher.

CONTENTS

USING THE PRODUCT SAFELY.....	I -IV
1 GETTING STARTED	1
1-1. PSW Series Overview	1
1-1-1. Series lineup.....	1
1-1-2. Main Features.....	2
1-1-3. Accessories.....	2
1-2. Appearance	4
1-2-1. PSW Front Panel.....	4
1-2-2. Rear Panel.....	6
1-3. Theory of Operation	9
1-3-1. Operating Area Description.....	9
1-3-2. CC and CV Mode	11
1-3-3. Slew Rate	12
1-3-4. Bleeder Control	13
1-3-5. Internal Resistance	14
1-3-6. Alarms	14
1-3-7. Considerations	15
1-3-8. Grounding.....	17
2 OPERATION	18
2-1. Set Up.....	18
2-1-1. Line Voltage Connection – Type III Models.....	18
2-1-2. Filter Installation	19
2-1-3. Power Up.....	19
2-1-4. Wire Gauge Considerations	20
2-1-5. Output Terminals(30V,80V,160V)	20
2-1-6. Using the Output Terminal Cover(30V,80V,160V).....	22
2-1-7. Output Terminals(250V,800V)	22
2-1-8. Using the Output Terminal Cover(250V,800V).....	25
2-1-9. Using the Rack Mount Kit.....	25
2-1-10. How to Use the Instrument.....	26
2-1-11. Reset to Factory Default Settings.....	26
2-1-12. View System Version and Build Date	27
2-2. Basic Operation	29
2-2-1. Setting OVP/OCP Levels.....	29
2-2-2. Set to C.V. Mode.....	30
2-2-3. Set to C.C. Mode.....	33
2-2-4. Display Modes	35
2-2-5. Panel Lock	35
2-2-6. Remote Sense	36
2-3. Parallel / Series Operation.....	38
2-3-1. Master-Slave Parallel Overview	39
2-3-2. Master-Slave Parallel Connection.....	40
2-3-3. Master-Slave Parallel Operation	42
2-3-4. Master-Slave Series Overview	43
2-3-5. Master-Slave Series Connection.....	45
2-3-6. Master-Slave Series Operation	46

2-4. Test Script	47
2-4-1. Filename of TestScript.....	47
2-4-2. Test Script Settings	47
2-4-3. Setting the Test Script.....	48
2-4-4. Load Test Script from USB drive	49
2-4-5. Run Test Script.....	49
2-4-6. Run Test Script (At Startup).....	50
2-4-7. Export Test Script to USB	50
2-4-8. Remove Test Script.....	51
2-4-9. Test Memory	51
2-4-10. Data structure of the test Script.....	52
2-4-11. Setting values of the test Script.....	53
3 CONFIGURATION	54
3-1. Configuration Table	54
3-2. Normal Function Settings.....	57
3-3. USB/GP-IB/RS-232C Settings.....	60
3-4. LAN Settings	60
3-5. System Settings	61
3-6. Power On Configuration Settings	62
3-7. Calibration	63
3-8. Setting Normal Function Settings	63
3-9. Setting Power On Configuration Settings.....	64
4 ANALOG CONTROL	65
4-1. Analog Remote Control Overview.....	65
4-1-1. Analog Control Connector Overview	65
4-1-2. External Voltage Control of Voltage Output	67
4-1-3. External Voltage Control of Current Output	68
4-1-4. External Resistance Control of Voltage Output	70
4-1-5. External Resistance Control of Current Output	71
4-1-6. External Control of Output	73
4-1-7. External control of Shutdown	74
4-2. Remote Monitoring	76
4-2-1. External Voltage and Current Monitoring	76
4-2-2. External Operation and Status Monitoring	77
5 Digital Control	79
5-1. Interface Configuration	79
5-1-1. USB Remote Interface	79
5-1-2. Configure GP-IB Interface	79
5-1-3. Configure RS-232C Interface.....	80
5-1-4. Configure Ethernet Connection	80
5-1-5. Web Server Configuration	81
5-1-6. Sockets Server Configuration.....	81
5-1-7. USB Remote Control Function Check.....	82
5-1-8. Web Server Remote Control Function Check.....	82
5-1-9. Socket Server Function Check	83
6 MAINTENANCE	87
6-1. Replacing the Dust Filter.....	87
7 FAQ	88

8 APPENDIX	89
8-1. PSW Default Settings	89
8-2. Error Messages & Messages	91
8-3. LCD Display Format	91
9 Specifications	92
9-1. PSW 360W Type I	92
9-2. PSW 720W Type II	95
9-3. PSW 1080W Type III	98
9-4. Common	101
9-5. PSW Dimensions	102



USING THE PRODUCT SAFELY

■ Preface

To use the product safely, read instruction manual to the end. Before using this product, understand how to correctly use it. If you read the manuals but you do not understand how to use it, ask us or your local dealer. After you read the manuals, save it so that you can read it anytime as required.

■ Pictorial indication

The manuals and product show the warning and caution items required to safely use the product. The following pictorial indication is provided.

Pictorial indication	
	Some part of this product or the manuals may show this pictorial indication. In this case, if the product is incorrectly used in that part, a serious danger may be brought about on the user's body or the product. To use the part with this pictorial indication, be sure to refer to the manuals.
 	If you use the product, ignoring this indication, you may get killed or seriously injured. This indication shows that the warning item to avoid the danger is provided. If you incorrectly use the product, ignoring this indication, you may get slightly injured or the product may be damaged. This indication shows that the caution item to avoid the danger is provided.

Please be informed that we are not responsible for any damages to the user or to the third person, arising from malfunctions or other failures due to wrong use of the product or incorrect operation, except such responsibility for damages as required by law.

USING THE PRODUCT SAFELY



■ Do not remove the product's covers and panels

Never remove the product's covers and panels for any purpose. Otherwise, the user's electric shock or fire may be incurred.

■ Warning on using the product

Warning items given below are to avoid danger to user's body and life and avoid the damage or deterioration of the product. Use the product, observing the following warning and caution items.

■ Warning items on power supply

● Power supply voltage

The rated power supply voltages of the product are 100VAC. The rated power supply voltage for each product should be confirmed by reading the label attached on the back of the product or by the "rated" column shown in the instruction manual. The specification of power cord attached to the products is rated to 125VAC for all products which are designed to be used in the areas where commercial power supply voltage is not higher than 125VAC. Accordingly, you must change the power cord if you want to use the product at the power supply voltage higher than 125VAC. If you use the product without changing power cord to 250VAC rated one, electric shock or fire may be caused. When you used the product equipped with power supply voltage switching system, please refer to the corresponding chapter in the instruction manuals of each product.

● Power cord

(IMPORTANT) The attached power cord set can be used for this device only.

If the attached power cord is damaged, stop using the product and call us or your local dealer. If the power cord is used without the damage being removed, an electric shock or fire may be caused.

● Protective fuse

If an input protective fuse is blown, the product does not operate. For a product with external fuse holder, the fuse may be replaced. As for how to replace the fuse, refer to the corresponding chapter in the instruction manual. If no fuse replacement procedures are indicated, the user is not permitted to replace it. In such case, keep the case closed and consult us or your local dealer. If the fuse is incorrectly replaced, a fire may occur.

USING THE PRODUCT SAFELY

■ **Warning item on Grounding**

If the product has the GND terminal on the front or rear panel surface, be sure to ground the product to safely use it.

■ **Warnings on Installation environment**

● **Operating temperature and humidity**

Use the product within the operating temperature indicated in the “rating” temperature column. If the product is used with the vents of the product blocked or in high ambient temperatures, a fire may occur. Use the product within the operating humidity indicated in the “rating” humidity column. Watch out for condensation by a sharp humidity change such as transfer to a room with a different humidity. Also, do not operate the product with wet hands. Otherwise, an electric shock or fire may occur.

● **Use in gas**

Use in and around a place where an inflammable or explosive gas or steam is generated or stored may result in an explosion and fire. Do not operate the product in such an environment. Also, use in and around a place where a corrosive gas is generated or spreading causes a serious damage to the product. Do not operate the product in such an environment.

● **Installation place**

Do not insert metal and inflammable materials into the product from its vent and spill water on it. Otherwise, electric shock or fire may occur.

■ **Do not let foreign matter in**

Do not insert metal and inflammable materials into the product from its vent and spill water on it. Otherwise, electric shock or fire may occur.

■ **Warning item on abnormality while in use**

If smoke or fire is generated from the product while in use, stop using the product, turn off the switch, and remove the power cord plug from the outlet. After confirming that no other devices catch fire, ask us or your local dealer.

USING THE PRODUCT SAFELY

■ Input / Output terminals

Maximum input to terminal is specified to prevent the product from being damaged. Do not supply input, exceeding the specifications that are indicated in the "Rating" column in the instruction manual of the product. Also, do not supply power to the output terminals from the outside. Otherwise, a product failure is caused.

■ Calibration

Although the performance and specifications of the product are checked under strict quality control during shipment from the factory, they may be deviated more or less by deterioration of parts due to their aging or others.

It is recommended to periodically calibrate the product so that it is used with its performance and specifications stable. For consultation about the product calibration, ask us or your local dealer.

■ Daily Maintenance

When you clean off the dirt of the product covers, panels, and knobs, avoid solvents such as thinner and benzene. Otherwise, the paint may peel off or resin surface may be affected. To wipe off the covers, panels, and knobs, use a soft cloth with neutral detergent in it.

During cleaning, be careful that water, detergents, or other foreign matters do not get into the product.

If a liquid or metal gets into the product, an electric shock and fire are caused.

During cleaning, remove the power cord plug from the outlet.

Use the product correctly and safely, observing the above warning and caution items. Because the instruction manual indicates caution items even in individual items, observe those caution items to correctly use the product.

If you have questions or comments about the manuals, ask us or E-Mail us.

1 GETTING STARTED

This chapter describes the power supply in a nutshell, including its main features and front / rear panel introduction. After going through the overview, please read the theory of operation to become familiar with the operating modes, protection modes and other safety considerations.

1-1. PSW Series Overview

1-1-1. Series lineup

The PSW series consists of 9 models, divided into 3 different model types covering 3 power capacities: Type I(360W), Type II(720W) and Type III(1080 W).

Model name	Type	Voltage Rating	Current Rating	Power
PSW-360L30	Type I	0~30V	0~36A	360W
PSW-360L80	Type I	0~80V	0~13.5A	360W
PSW-360M160	Type I	0~160V	0~7.2A	360W
PSW-360M250	Type I	0~250V	0~4.5A	360W
PSW-360H800	Type I	0~800V	0~1.44A	360W
PSW-720L30	Type II	0~30V	0~72A	720W
PSW-720L80	Type II	0~80V	0~27A	720W
PSW-720M160	Type II	0~160V	0~14.4A	720W
PSW-720M250	Type II	0~250V	0~9.0A	720W
PSW-720H800	Type II	0~800V	0~2.88A	720W
PSW-1080L30	Type III	0~30V	0~108A	1080W
PSW-1080L80	Type III	0~80V	0~40.5A	1080W
PSW-1080M160	Type III	0~160V	0~21.6A	1080W
PSW-1080M250	Type III	0~250V	0~13.5A	1080W
PSW-1080H800	Type III	0~800V	0~4.32A	1080W

Apart from the differences in output, each unit differs in size. The 720 and 1080 watt models are larger than the 360 watt models to accommodate the increase in power.

360 W model
Type I

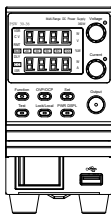

720 W model
Type II

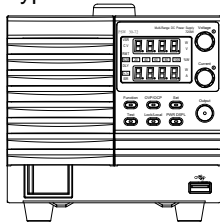

1080 W model
Type III

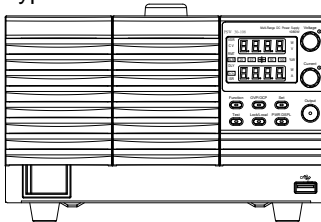

1-1-2. Main Features

Performance	<ul style="list-style-type: none"> • High performance/power. • Power efficient switching type power supply. • Low impact on load devices. • Fast transient recovery time of 1ms. • Fast output response time.
Features	<ul style="list-style-type: none"> • OVP, OCP and OTP/OHP protection. • Adjustable voltage and current slew rates. • User adjustable bleeder control to quickly dissipate the power after shutdown to safe levels. • Extensive remote monitoring and control options. • Support for serial* and parallel connections. *(30, 80, 160 volt models only) • Power on configuration settings. • Supports test scripts. • Web server monitoring and control.
Interface	<ul style="list-style-type: none"> • Ethernet port (Socket/Web) • Analog connector for analog voltage and current monitoring • USB host port and device port • Option:GP-IB,RS-232C

1-1-3. Accessories

Standard Accessories	Part number	Description
	CD ROM	User manual, Programming manual, USB Driver, Test Script Data
	Power cord	Depends on Regional and Type.
	PSW-009	Output terminal cover(30,80,160 volt models)
	PSW-011	Output terminal cover(250,800 volt models)
	PSW-012	High voltage output terminal (250,800 volt models)
	GTL-123	Test leads:1x red,1x black (30,80,160 volt models)
	GTL-240	USB Cable
	PSW-004	Basic Accessory Kit(30,80,160 volt models) M4 terminal screw and washers x2 M8 terminal bolts,nuts and washers x 2 Air filter x 1 Analog control protection dummy x 1 Analogcontrol lock level x 1

PSW-008 Basic Accessory Kit: (250,800 volt models)
 Air filter x1
 Analog control protection dummy x1
 Analog control lock level x1

Option	Part number	Description
	GET-001	Extended terminal(30,80,160 volt models)
	GET-002	Extended terminal(250,800 volt models)
	PSW-001	Accessory Kit: Pin contact x 10、Socket x 1 Protection cover x 1 (Compatible with OMRON XG5M-2635-N)
	PSW-005	Series operation cable for 2 units (30,80,160 volt models)
	PSW-006	Parallel operation cable for 2 units
	PSW-007	Parallel operation cable for 3 units
	GRA-410-J	Rack mount adapter (JIS)
	GRA-410-E	Rack mount adapter (EIA)
	GUG-001	GP-IB to USB adapter
	GUR-001	RS-232C to USB adapter
	GUR-001A	RS-232C to USB adapter
	GTL-240	USB cable
	GTL-130	Test leads: 1x red, 1x black (250,800 volt models)
	PSW-010	Air filter (Type II/III)

Driver	Name	Description
	texio_cdc*.inf	USB driver

1-2. Appearance

1-2-1. PSW Front Panel

PSW-720**** (720W:Typell)

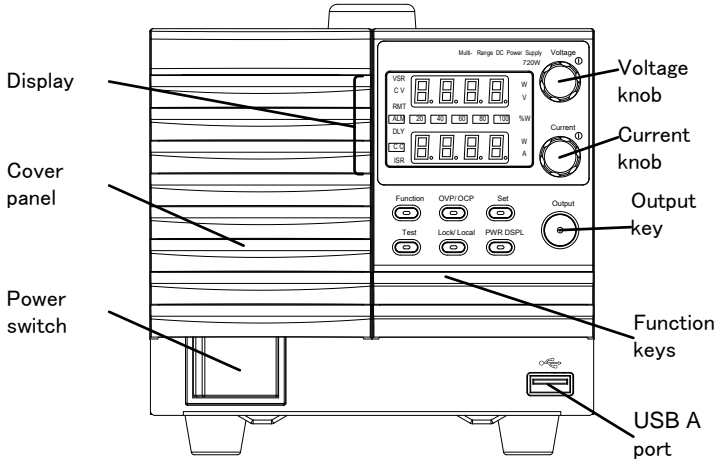

PSW-1080**** (1080W:Typelll)

PSW-360****(360W:Typel)

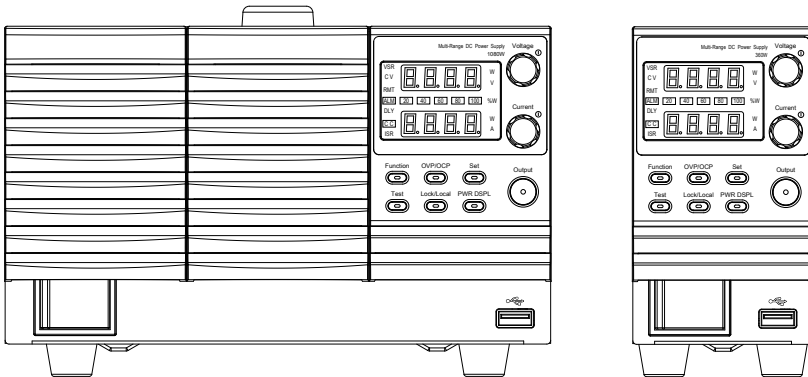

Function keys

The Function keys along with the Output key will light up when a key is active.

Function



Function

The Function key is used to configure the power supply.

OVP/OCP



OVP/OCP

Set the over current or over voltage protection levels.



Set
Sets the current and voltage limits.



Test
Used to run customized scripts for testing.



Lock/Local
Locks or unlocks the panel keys to prevent accidentally changing panel settings.

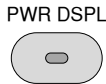

PWR DSPL
Toggles the display from viewing V/A → V/W → V/A
Press the Current knob to switch the display from V/W to W/A.

Display indicators

VSR

Voltage Slew Rate

C V

Constant Voltage Mode

RMT

Remote Control Mode

ALM

Alarm on

DLY

Delay Output

C C

Constant Current Mode

ISR

Current Slew Rate



Power bar

Indicates the current power output as a percentage.

Voltage knob

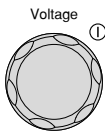

Sets the voltage.

Setting can be settled when push the knob.

Current knob

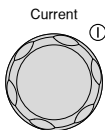

Sets the current.

Setting can be settled when push the knob.

Output

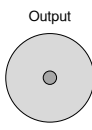

Press to turn on the output. The Output key will light up when the output is active.

USB



USB A port for data transfer, loading test scripts etc.

Power Switch

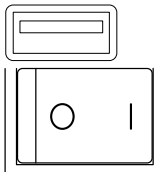

Used to turn the power on/off.

1-2-2. Rear Panel

PSW-720M160, PSW-720L80, PSW-720L30 (720W)

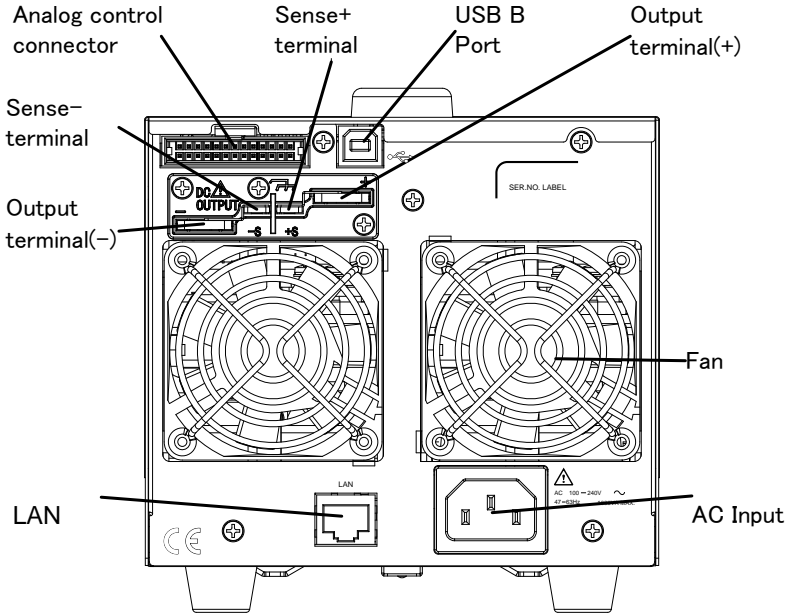

PSW-1080M160, PSW-1080L80, PSW-1080L30 (1080W)

PSW-360M160, PSW-360L80, PSW-360L30 (360W)

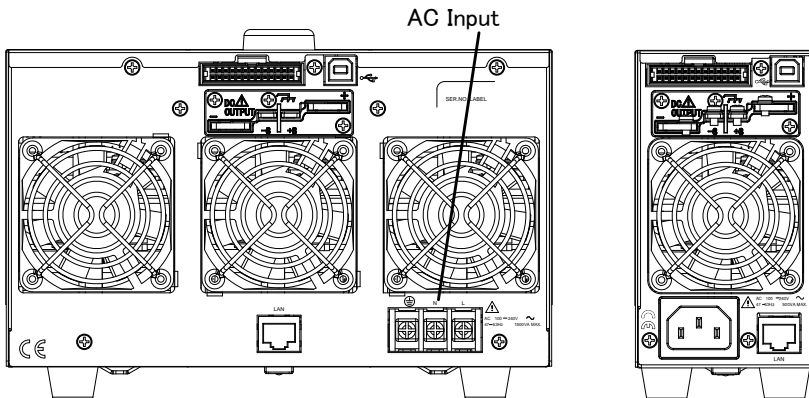

PSW-720H800, PSW-720M250 (720W)

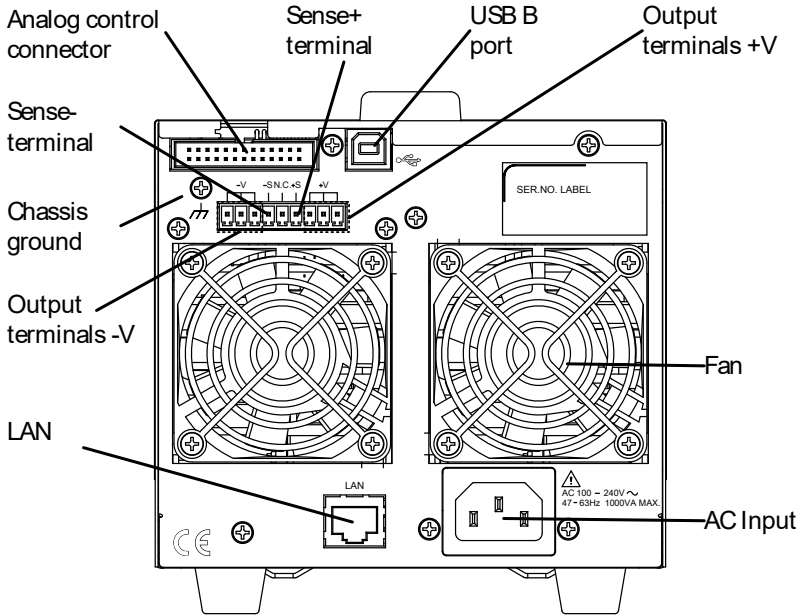

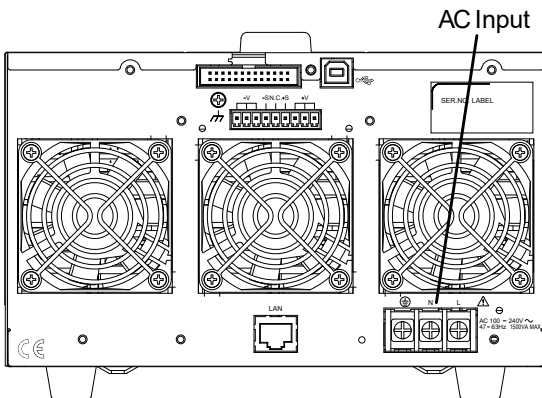

PSW-1080H800, PSW-1080H250, (1080W)



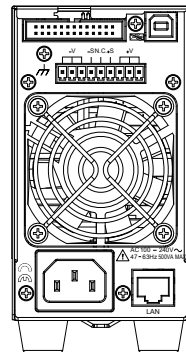

PSW-360H800
PSW-360M250
(360W)

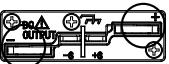

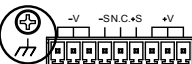

Analog Control Connector  Standard 26 pin MIL connector (OMRON XG4C Plug).
 The analog control connector is used to monitor current and voltage output, machine status (OVP, OCP, OTP/OHP etc.), and for analog control of the current and voltage output.
 Use an OMRON XG5M socket as the mating socket.

Output Terminals (30V,80V,160V)  Positive (+) and negative (-) output terminals.
 Chassis ground
 Sense (-) and Sense (+) terminals.

Output Terminals (250V, 800V) The 250 and 800 volt models use a 9 pin connector and a plug for the output and sense terminal connections. The plug is a MC420-38109Z plug by DECA SwitchLab Inc. This plug is also available separately

 Positive (V+) and negative (V-) output terminals (3 of each).
 Chassis ground
 Sense (-S) and Sense (+S) terminals.

USB B port  The USB B port is used for remote control.

Fans  Temperature controlled fans

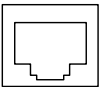
Ethernet port  The ethernet port is used for remote control and digital monitoring from a PC.

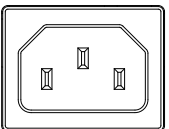
Line Voltage Input (Type I/TypeII)  Type I: PSW-360L30/L80/M160/M250/H800
 Type II: PSW-720L30/L80/M160/M250/H800
 • Voltage Input: 100~240 VAC
 • Line frequency: 50Hz/60Hz (automatically switchable)

Line Voltage
Input
(Type III)

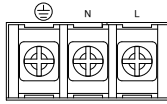

Type III:PSW-1080L30/L80/M160/M250/H800

- Voltage Input: 100~240 VAC
- Line frequency: 50Hz/60Hz
(automatically switchable)

1-3. Theory of Operation

The theory of operation chapter describes the basic principles of operation, protection modes and important considerations that must be taken into account before use.

1-3-1. Operating Area Description

Background

The PSW power supplies are regulated DC power supplies with a high voltage and current output. These operate in CC or CV mode within a wide operating range limited only by the output power.

The operating area of each power supply is determined by the rated output power as well as the voltage and current rating. For example the operating area and rated power output for the PSW-360L30 is shown below.

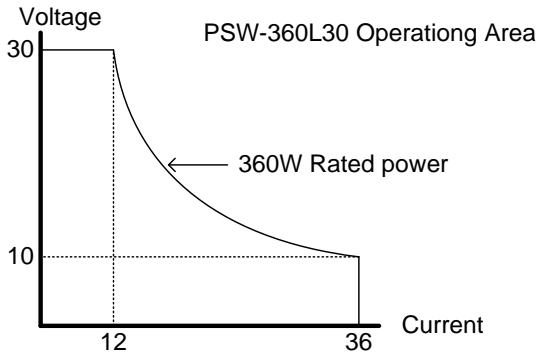

When the power supply is configured so that the total output (current x voltage output) is less than the rated power output, the power supply functions as a typical constant current, constant voltage power supply. If however, the power supply is configured such that the total output (current x voltage output) exceeds the rated power output, the effective output is actually limited to the power limit of the unit. In this case the output current and voltage then depend purely on the load value.

PSW 30V Series Operating Area

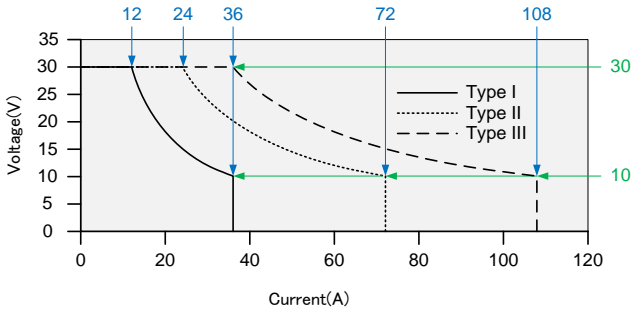

PSW 80V Series Operating Area

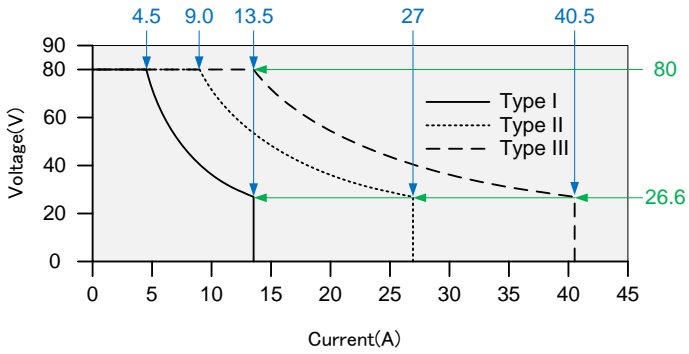

PSW 160V Series Operating Area

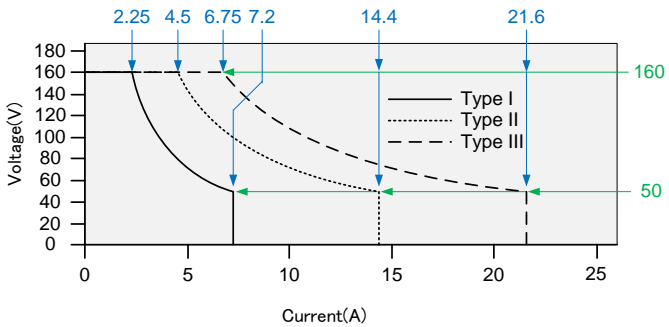

PSW 250V Series Operating Area

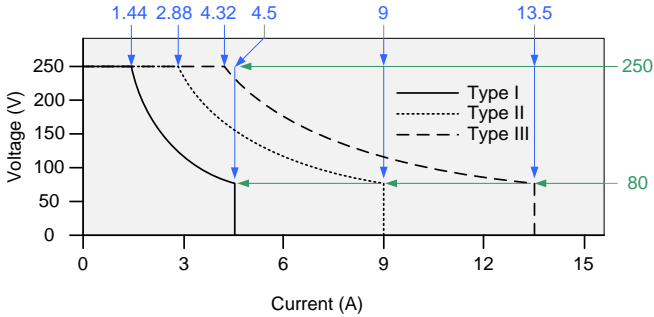

PSW 800V Series Operating Area

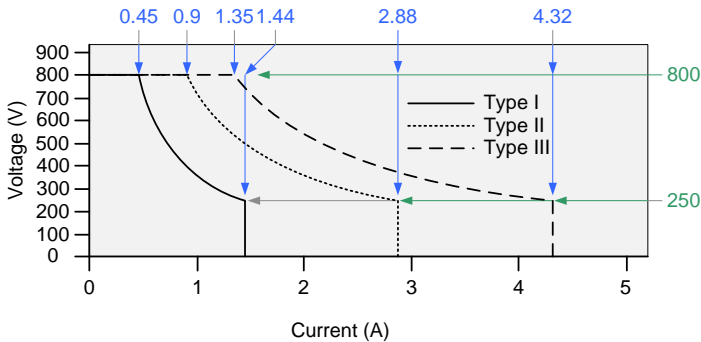

1-3-2. CC and CV Mode

CC and CV mode
Description

When the power supply is operating in constant current mode (CC) a constant current will be supplied to the load. When in constant current mode the voltage output can vary, whilst the current remains constant. When the load resistance increases to the point where the current limit (I_{SET}) can no longer be sustained the power supply switches to CV mode. The point where the power supply switches modes is the crossover point. When the power supply is operating in CV mode, a constant voltage will be supplied to the load, whilst the current will vary as the load varies. At the point that the load resistance is too low to maintain a constant voltage, the power supply will switch to CC mode and maintain the set current limit. The conditions that determine whether the power supply operates in CC or CV mode depends on the set current (I_{SET}), the set voltage (V_{SET}), the load resistance (R_L) and

the critical resistance (R_C). The critical resistance is determined by V_{SET}/I_{SET} . The power supply will operate in CV mode when the load resistance is greater than the critical resistance. This means that the voltage output will be equal to the V_{SET} voltage but the current will be less than I_{SET} . If the load resistance is reduced to the point that the current output reaches the I_{SET} level, the power supply switches to CC mode.

Conversely the power supply will operate in CC mode when the load resistance is less than the critical resistance. In CC mode the current output is equal to I_{SET} and the voltage output is less than V_{SET} .

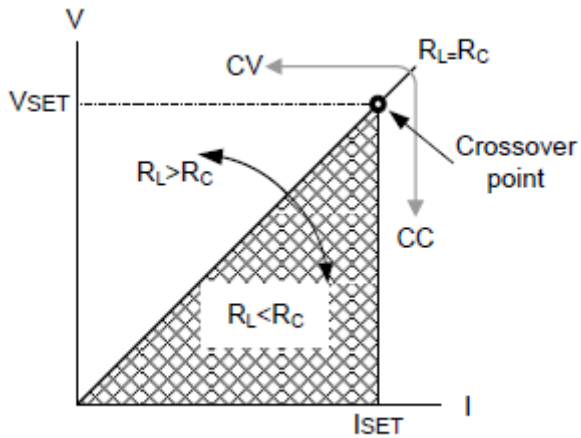

1-3-3. Slew Rate

Theory

The PSW has selectable slew rates for CC and CV mode. This gives the PSW power supply the ability to limit the current/voltage draw of the power supply. Slew rate settings are divided into High Speed Priority and Slew Rate Priority. High Speed Priority mode disables slew rate settings for CC or CV mode. Slew Rate Priority mode allows for user adjustable slew rates for CC or CV mode. The rising and falling slew rate can be set independently.

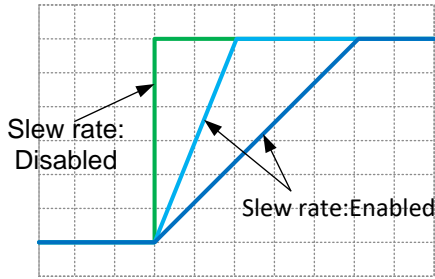

1-3-4. Bleeder Control

Background

The PSW DC power supplies employ a bleed resistor in parallel with the output terminals.

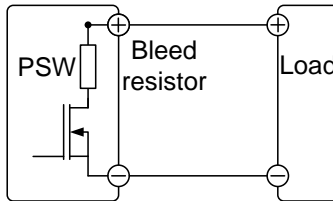

Bleed resistors are designed to dissipate the power from the power supply filter capacitors when power is turned off and the load is disconnected. Without a bleed resistor, power may remain charged on the filter capacitors for some time and be potentially hazardous.

In addition, bleed resistors also allow for smoother voltage regulation of the power supply as the bleed resistor acts as a minimum voltage load.

The bleed resistance can be turned on or off using the configuration settings

A setting of AUTO to turn on the bleeder when output is on, the output will turn off the bleeder when off.



Note

By default the bleed resistance is on. For battery charging applications, be sure to turn the bleed resistance off as the bleed resistor can discharge the connected battery when the unit is off.

1-3-5. Internal Resistance

Background On the PSW, the internal resistance of the power supply can be user-defined in software. (Internal Resistance Setting, page 57). When the internal resistance is set it can be seen as a resistance in series with the positive output terminal. This allows the power supply to simulate power sources that have internal resistances such as lead acid batteries.

Internal Resistance Range	Model	Internal Resistance Range
	PSW-360L30	0.000 ~ 0.833Ω
	PSW-720L30	0.000 ~ 0.417Ω
	PSW-1080L30	0.000 ~ 0.278Ω
	PSW-360L80	0.000 ~ 5.926Ω
	PSW-720L80	0.000 ~ 2.963Ω
	PSW-1080L80	0.000 ~ 1.975Ω
	PSW-360M160	0.000 ~ 22.222Ω
	PSW-720M160	0.000 ~ 11.111Ω
	PSW-1080M160	0.000 ~ 7.407Ω
	PSW-360M250	0.00 ~ 55.55Ω
	PSW-720M250	0.00 ~ 27.77Ω
	PSW-1080M250	0.00 ~ 18.51Ω
	PSW-360H800	0.0 ~ 555.5Ω
	PSW-720H800	0.0 ~ 277.8Ω
	PSW-1080H800	0.0 ~ 185.1Ω

1-3-6. Alarms

The PSW power supplies have a number of protection features. When one of the protection alarms are set, the ALM icon on the display will be lit. For details on how to set the protection modes, please see page 29.

OVP	Over voltage protection (OVP) prevents a high voltage from damaging the load.
OCP	Over current protection prevents high current from damaging the load.
OTP/OHP	Over temperature protection protects the instrument from overheating
Power Switch Trip	When the Power Switch Trip configuration setting is enabled, the power supply will automatically shut down when a protection setting has been tripped (OCP, OVP, OTP/OHP).
Alarm output	Alarms are output via the analog control connector. The alarm output is an isolated open-collector photo coupler output.

1-3-7. Considerations

The following situations should be taken into consideration when using the power supply.

Inrush current

When the power supply switch is first turned on, an inrush current is generated. Ensure there is enough power available for the power supply when first turned on, especially if a number of units are turned on at the same time.



Note

Allow at least 15 seconds between cycling the power by the external breaker, the shutdown function and power switch.

Cycling the power on and off quickly can cause the inrush current limiting circuit to fail as well as reduce the working life of the input fuse and power switch.

Pulsed or Peaked loads

When the load has current peaks or is pulsed, it is possible for the maximum current to exceed the mean current value. The PSW power supply ammeter only indicates mean current values, which means for pulsed current loads, the actual current can exceed the indicated value. For pulsed loads, the current limit must be increased, or a power supply with a greater capacity must be chosen. As shown below, a pulsed load may exceed the current limit and the indicated current on the power supply ammeter.

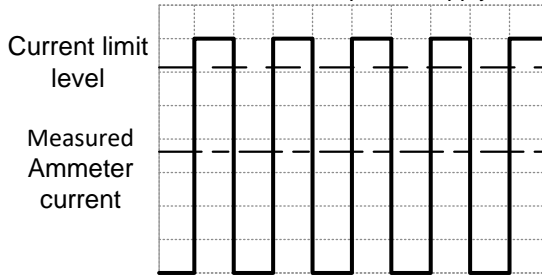

Reverse Current: Regenerative load When the power supply is connected to a regenerative load such as a transformer or inverter, reverse current will feed back to the power supply. The PSW power supply cannot absorb reverse current. For loads that create reverse current, connect a resistor in parallel to the power supply to bypass the reverse current.

To calculate the minimum resistance for the resistor, R_D , first determine the maximum reverse current, I_R , and determine what the output voltage, E_o , will be.

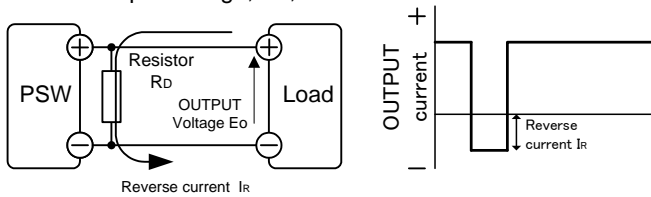

$$R_D[\Omega] \leq E_o [V] \div I_R [A]$$

 **Note**

The current output will decrease by the amount of current absorbed by the resistor. Ensure the resistor used can withstand the power capacity of the power supply/load.

Reverse Current: Accumulative energy

When the power supply is connected to a load such as a battery, reverse current may flow back to the power supply. To prevent damage to the power supply, use a reverse-current-protection diode in series between the power supply and load.

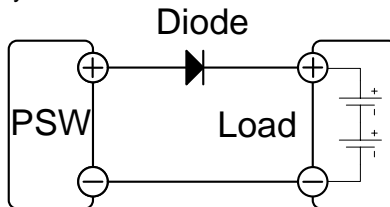

 **Note**

Ensure the reverse withstand voltage of the diode is able to withstand 2 times the rated output voltage of the power supply and the forward current capacity can withstand 3 to 10 times the rated output current of the power supply. Ensure the diode is able to withstand the heat generated in the following scenarios.

When the diode is used to limit reverse voltage, remote sensing cannot be used.

When connect to the charged load, should be careful to avoid electric shocks and sparks.

1-3-8. Grounding

The output terminals of the PSW power supplies are isolated with respect to the protective grounding terminal. The insulation capacity of the load, the load cables and other connected devices must be taken into consideration when connected to the protective ground or when floating.

Floating

As the output terminals are floating, the load and all load cables must have an insulation capacity that is greater than the isolation voltage of the power supply.

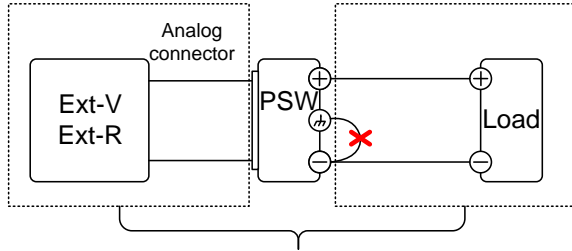

() Insulation capacity \geq Isolation voltage of Power supply



WARNING

If the insulation capacity of the load and load cables is not greater than the isolation voltage of the power supply, electric shock may occur.

Grounded output terminal

If the positive or negative terminal is connected to the protective ground terminal, the insulation capacity needed for the load and load cables is greatly reduced. The insulation capacity only needs to be greater than the maximum output voltage of the power supply with respect to ground.

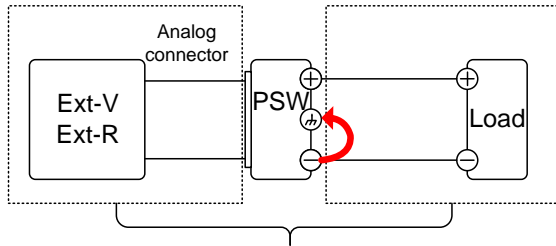

() Insulation capacity \geq Voltage of power supply with respect to ground



Note

If using external voltage control, do not ground the external voltage terminal as this will create a short circuit.

2 OPERATION

2-1. Set Up

2-1-1. Line Voltage Connection – Type III Models

Background Type III (PSW-1080L30/L80/M160/M250/H800) models use a universal power input that can be used with 100 and 200 VAC systems. To connect or replace the power cord.



WARNING

The following procedure should only be attempted by competent persons

Ensure the AC power cord is not connected to power.

Removal

1. Turn off the power switch.

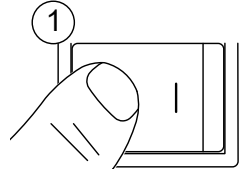

2. Unscrew the power cord protective sheath.
3. Remove the 2 screws holding the power cord cover and remove.

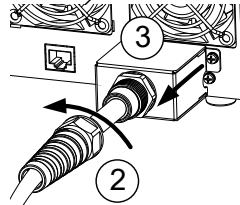

4. Slide the cover off the AC terminals.
5. Remove the AC power cord wires.

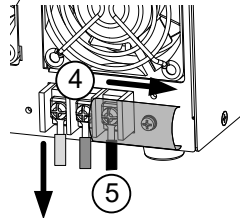

Installation

1. Connect the AC power cord wires to the AC input terminals.
 - White/Blue → Neutral (N)
 - Green/Green-yellow → GND (⊕)
 - Black/Brown → Line (L)

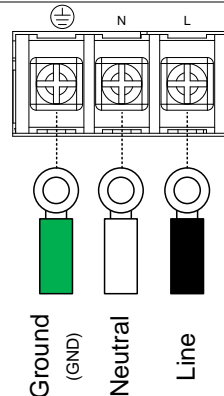

2. Set the cover back over the AC terminals.

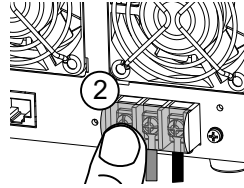

3. Re-install the power cord cover.
4. Screw the power cord sheath back onto the cover.

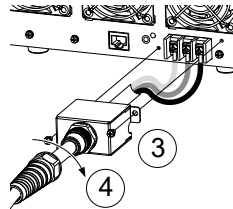

2-1-2. Filter Installation

Background

The PSW has a small filter that must first be inserted under the control panel before operation. The small filter must be inserted for all model types (Type I/II/III).

Steps

1. Insert the small filter in the open area under the control panel.



Type II shown as an example

2. The unit is now ready to power up.

2-1-3. Power Up

Steps

1. Type I or II: Connect the power cord to the rear panel socket.

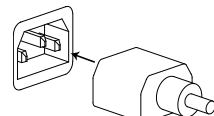

Type III: Connect the power cord to the universal power input.

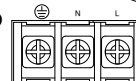

2. Press the POWER key. If used for the first time, the default settings will appear on the display, otherwise The PSW recovers the state right before the power was last turned OFF.

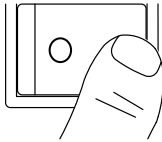

Note

The power supply takes around 15 seconds to fully turn on and shutdown.

Do not turn the power on and off quickly. Please wait display is turned OFF completely. (About 15 seconds)

2-1-4. Wire Gauge Considerations

Background

Before connecting the output terminals to a load, the wire gauge of the cables should be considered.

It is essential that the current capacity of the load cables is adequate. The rating of the cables must equal or exceed the maximum current rated output of the instrument.

Recommended wire gauge

Wire Gauge (AWG)	Maximum Current
20	2.5A
18	4A
16	6A
14	10A
12	16A
10	21A
8	36A
6	61A
4	97A

The maximum temperature rise can only be 60 degrees above the ambient temperature. The ambient temperature must be less than 30 deg.

2-1-5. Output Terminals(30V,80V,160V)

Background

Before connecting the output terminals to the load, first consider whether voltage sense will be used, the gauge of the cable wiring and the withstand voltage of the cables and load.

The output terminals can be connected to load cables using M4 sized screws or M8 sized bolts.



WARNING

Dangerous voltages. Ensure that the power to the instrument is disabled before handling the power supply output terminals. Failing to do so may lead to electric shock.

Steps

1. Turn the power switch off.

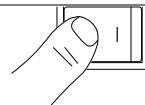

2. Remove the output terminal cover.

3. If necessary, screw the chassis ground terminal to either the positive or negative terminal. See the grounding chapter for details.

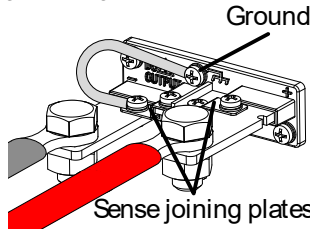

4. Choose a suitable wire gauge for the load cables.
5. Choose a suitable crimp for the terminals.
6. If using voltage sense, remove the sense terminal joining plates and connect sensing wires to the load(s).
7. Connect the positive load cable to the positive output terminal and the negative cable to the negative output terminal.
8. Reattach the output terminal cover

Connection without sense wiring

Using M4 screws

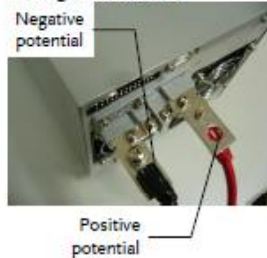

Using M8 bolts

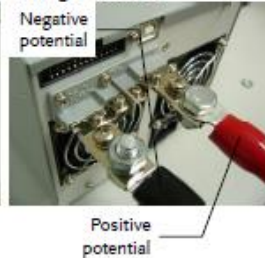

Connection with sense wiring

Using M4 screws

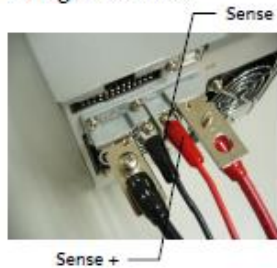

Using M8 bolts

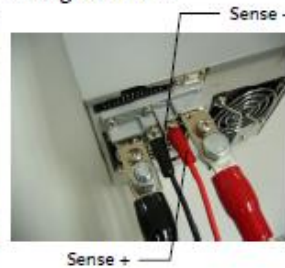

2-1-6. Using the Output Terminal Cover(30V,80V,160V)

Steps

1. Remove the screw holding the top cover to the bottom cover.
2. Line-up the bottom cover with the notches in the output terminals.
3. Place the top terminal cover over the bottom cover.

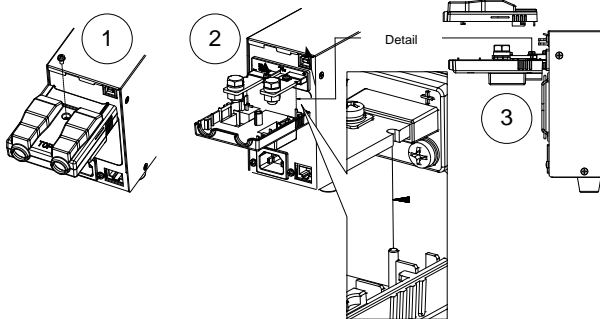

4. Use your thumb to slide the terminal covers shut, as shown in the diagram below.
5. When the top and bottom covers are flush, re-insert the screw that was removed in step 1.

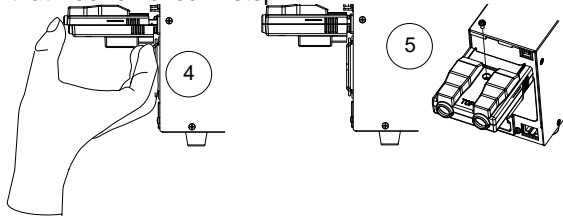

Removal

Reverse the procedure to remove the terminal covers.

2-1-7. Output Terminals(250V,800V)

Background

The high voltage models (PSW 250 and PSW 800 models) use a 9 pin socket for the output voltage and sense connections. The corresponding plugs (DECA SwitchLab MC420-38109Z/PSW-012) should be used to connect the terminals to the appropriate cable. Before connecting the output terminals to the load, first consider whether voltage sense will be used, the gauge of the cable wiring and the withstand voltage of the cables and load.



WARNING

Dangerous voltages. Ensure that the power to the instrument is disabled before handling the power supply output terminals. Failing to do so may lead to electric shock.

Please note the wire gauge used and the capacity of the plug/socket. It may be necessary to wire the load to a number of terminals to offset the capacity over a number of terminals.

Output Connector Overview

When using the output connector make sure the wires that are used follow the following guidelines:

- Wire gauge: AWG 26 ~ AWG 16
- Strip length 6.5mm // 0.26 in.
- Current rating 10A
- Insulation resistance AC 2000V min
- Insulation withstand voltage >2000MΩ DC500V
- Operation Temperature -40°C ~ +105°C

Output Connector Pinout

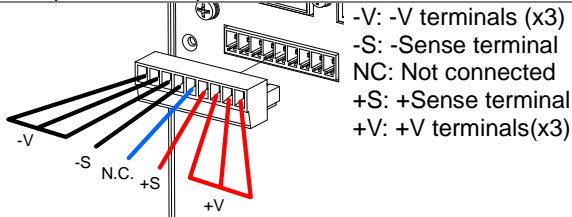

Wiring the Connector Plug

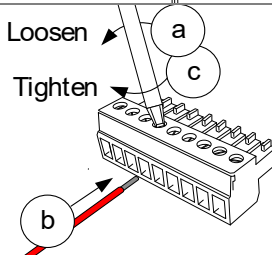

- a. Unscrew the appropriate terminal anticlockwise to release the receptacle.
- b. Insert a wire that has had at least ~7mm stripped from the insulation.
- c. Tighten the receptacle by screwing clockwise.

Steps

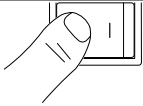
1. Turn the power switch off. 
2. Remove the output terminal cover. Page25
3. Choose a suitable wire gauge for the load cables. Page 20
4. Strip ~7mm from one end of each load cable.
5. Connect the positive load cable to one of the +V pins and the negative cable to one of the -V pins.



WARNING

Please note the wire gauge used and the capacity of the plug/socket. It may be necessary to wire the load to a number of terminals to offset the capacity over a number of terminals.

6. If using local sense, connect the -S pin to a -V pin, and connect the +S pin to a +V pin.

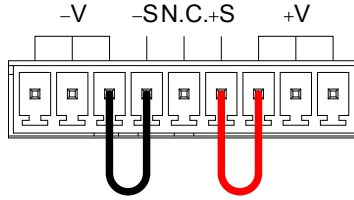

7. If not using local sense, see the remote sense section to wire the sense terminals for remote sensing. Page 36
8. If necessary, connect the chassis ground terminal to either the -V or +V pin. See the grounding chapter for details. Page 17

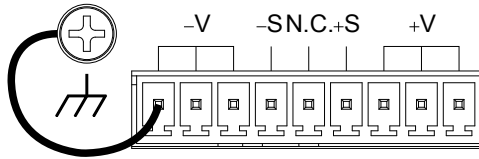

9. Reattach the output terminal cover. Page 25

Local Sense Wiring

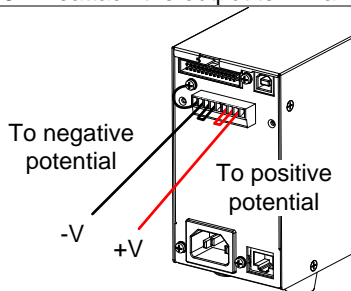

Remote Sense Wiring

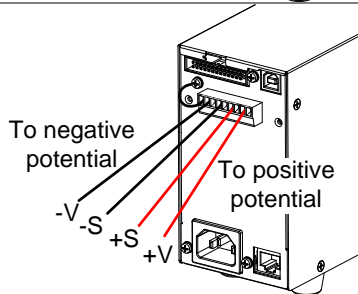

2-1-8. Using the Output Terminal Cover(250V,800V)

Steps

1. Screw the bottom cover onto the rear panel using the two M4 screws.

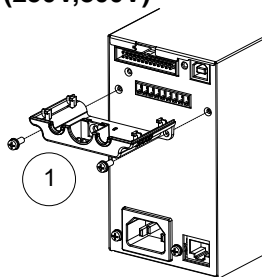

2. Slide the top cover over the bottom cover.

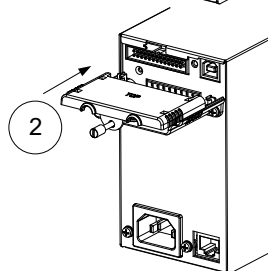

3. Finally, secure the top cover with the screw in the center of the top cover.

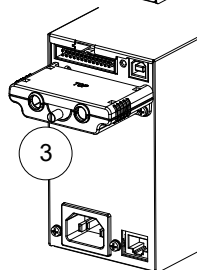

Removal

Reverse the procedure to remove the terminal covers.

2-1-9. Using the Rack Mount Kit

Background

The PSW series has an optional Rack Mount Kit: [JIS] GRA-410-J, [EIA] GRA-410-E[EIA]) that can be used to hold 6x PSW Type I models, 3x Type II models, 2x Type III models or a combination of all models (1x Type I, 1x Type II and 1x Type III).

Rack mount diagram

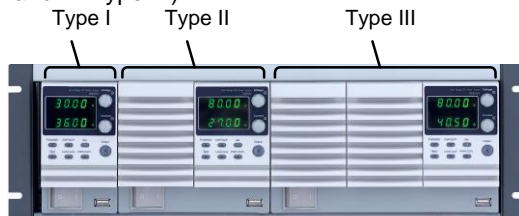

2-1-10. How to Use the Instrument

Background

The PSW power supplies use a novel method of configuring parameter values only using the voltage or current knobs. The knobs are used to quickly edit parameter values at 0.01, 0.1 or 1 unit steps at a time. When the user manual says to set a value or parameter, use the steps below.

Example

Use the voltage knob to set a voltage of 10.05 volts.

1. Repeatedly press the voltage knob until the last digit is highlighted. This will allow the voltage to be edited in 0.01 volt steps.
2. Turn the voltage knob till 0.05 volts is shown.

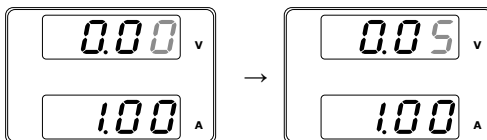
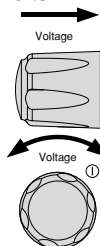

3. Repeatedly press the voltage knob until the first digit is highlighted. This will allow the voltage to be edited in 1 volt steps.
4. Turn the voltage knob until 10.05 is shown.

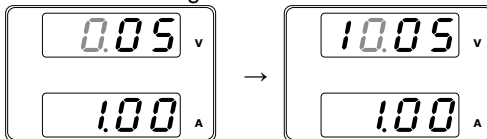

Note

Notice the Set key becomes illuminated when setting the current or voltage.

If the voltage or current knobs are unresponsive, press the Set key first.

2-1-11. Reset to Factory Default Settings

Background

The F-88 configuration setting allows the PSW to be reset back to the factory default settings. See page 89 for the default factory settings.

Steps

1. Press the Function key. The Function key will light up.
2. The display should show F-01 on the top and the configuration setting for F-01 on the bottom

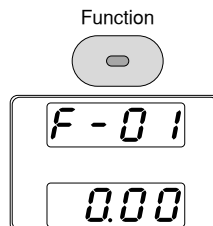

3. Rotate the voltage knob to change the F setting to F-88 (Factory Set Value)

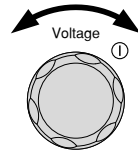

4. Use the current knob to set the F-88 setting to 1 (Return to factory settings).

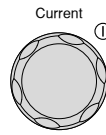

5. Press the Voltage knob to confirm. ConF will be displayed when successful.

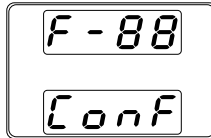
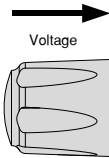

6. Press the Function key again to exit. The function key light will turn off.



Note

Data of the test script is not cleared by the initialization by F-88. Please be cleared in the deletion of the test data.

2-1-12. View System Version and Build Date

Background

The F-89 configuration setting allows you to view the PSW version number, build date, keyboard version, analog-control version, kernel build, test command version and test command build date.

Steps

1. Press the Function key. The Function key will light up.



2. The display should show F-01 on the top and the configuration setting for F-01 on the bottom.



3. Rotate the voltage knob to change the F setting to F-89 (Show Version).

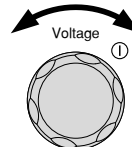

4. Rotate the current knob to view the version and build date for the various items

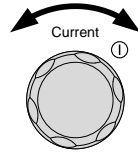

- F-89
- 0-XX : Main Program Version
 - 1-XX : Main Program Version
 - 2-XX : Main Program Build On-Year.
 - 3-XX : Main Program Build On-Year.
 - 4-XX : Main Program Build On-Month.
 - 5-XX : Main Program Build On-Day.
 - 6-XX : Keyboard CPLD version.
 - 7-XX : Keyboard CPLD version.
 - 8-XX : Analog CPLD version
 - 9-XX : Analog CPLD version
 - A-XX : Reserved
 - B-XX : Reserved
 - C-XX : Kernel Build On-Year
 - D-XX : Kernel Build On-Year
 - E-XX : Kernel Build On-Month
 - F-XX : Kernel Build On-Day
 - G-XX : Test Command Version
 - H-XX : Test Command Version
 - I-XX : Test Command Build On-Year
 - J-XX : Test Command Build On-Year
 - K-XX : Test Command Build On-Month
 - L-XX : Test Command Build On-Day
 - M-XX : USB Driver Version (Major)
 - N-XX : USB Driver Version (Minor)

5. Press the Function key again to exit.
The function key light will turn off.

Function



Example Main Program Version : Ver 1.09 : 2014/03/01
 0-01: Main Program Version
 1-09: Main Program Version
 2-20: Main Program Build On-Year
 3-11: Main Program Build On-Year
 4-08: Main Program Build On-Month
 5-01: Main Program Build On-Day

Example Keyboard CPLD version: 0x030c
 6-03: Keyboard CPLD version
 7-0c: Keyboard CPLD version

Example Analog CPLD version: 0x0421
 8-04: Analog CPLD Version.
 9-21: Analog CPLD Version.

Example Kernel Version: 2011/05/22
 C-20: Kernel Build On-Year

D-11: Kernel Build On-Year
 E-05: Kernel Build On-Month
 F-22: Kernel Build On-Day

Example Test Command Version : V01:00: 2014/03/01
 G-01: Test Command Version
 H-00: Test Command Version
 I-20: Test Command Build On-Year
 J-11: Test Command Build On-Year
 K-07: Test Command Build On-Month
 L-25: Test Command Build On-Day

Example USB Driver Version : V02.01:
 M-02: USB Driver Version (Major)
 N-01: USB Driver Version (Minor)

2-2. Basic Operation

2-2-1. Setting OVP/OCV Levels

Background

The OVP level has a selectable range of 10% to 110% of the rated output voltage. The OCP level has a selectable range 10%~ 110% of the rated output current, alternatively the OCP level can also be turned off. The OVP and OCP level is set to 110% by default.

When one of the protection measures are on, ALM is shown on the panel display. By default, the power switch will turn off when any of the protection levels are tripped.

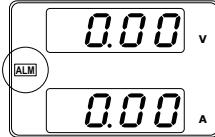

Before setting the OVP or OCP level



- Ensure the load is not connected.
- Ensure the output is set to off.

Setting Range

Model	PSW-360L30	PSW-720L30	PSW-1080L30
OVP Range(V)	3.00 - 33.00	3.00 - 33.00	3.00 - 33.00
OCP Range(A)	3.60 - 39.60	5.00 - 79.20	5.0 - 118.8
Model	PSW-360L80	PSW-720L80	PSW-1080L80
OVP Range(V)	8.00 - 88.00	8.00 - 88.00	8.00 - 88.00
OCP Range(A)	1.35 - 14.85	2.70 - 29.70	4.05 - 44.55
Model	PSW-360M160	PSW-720M160	PSW-1080M160
OVP Range(V)	16.0 - 176.0	16.0 - 176.0	16.0 - 176.0
OCP Range(A)	0.72 - 7.92	1.44 - 15.84	2.16 - 23.76
Model	PSW-360M250	PSW-720M250	PSW-1080M250
OVP Range(V)	20.0 - 275.0	20.0 - 275.0	20.0 - 275.0
OCP Range(A)	0.45-4.95	0.90 - 9.90	1.35 - 14.85
Model	PSW-360H800	PSW-720H800	PSW-1080H800
OVP Range(V)	20.0 - 880.0	20.0 - 880.0	20.0 - 880.0
OCP Range(A)	0.144 - 1.584	0.288 - 3.168	0.432 - 4.752

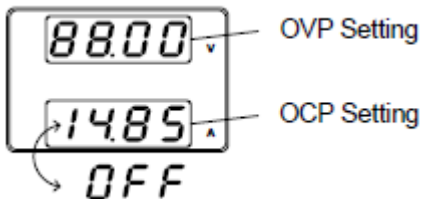
- | | | |
|-------|---|--|
| Steps | 1. Press the OVP/OCB key. The OVP/OCB key lights up. | OVP/OCB
 |
| | 2. The OVP setting will be displayed on the top and the OCB setting (or OFF) will be displayed on the bottom. | |

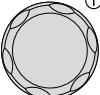
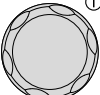

- | | | |
|-----------|--|--|
| OVP Level | 3. Use the voltage knob to set the OVP level. |  |
| | Range 10%~110% of rated output voltage | |
| OCB Level | 4. Use the current knob to set the OCB level. |  |
| | Current Range 10%~110% of rated output current | |
| | 5. Press OVP/OCB again to exit. The OVP/OCB indicator will turn off. | OVP/OCB
 |

Power switch trip	Set F-95 (Power switch trip) to 1 (to disable the power switch trip) or to 0 (to enable the power switch trip) and save. F-95 1 (Disable) or 0 (Enable)	
-------------------	--	--

Clear OVP/OCB protection	The OVP or OCB protection can be cleared after it has been tripped by holding the OVP/OCB button for 2 seconds. (Only applicable when the power switch trip setting is disabled [F-95 = 1]) OVP/OCB	OVP/OCB  (Hold)
--------------------------	---	---

2-2-2. Set to C.V. Mode

When setting the power supply to constant voltage mode, a current limit must also be set to determine the crossover point. When the current exceeds the crossover point, the mode switches to C.C. mode. For details about C.V. operation, see page 11.

C.C. and C.V. mode have two selectable slew rates: High Speed Priority and Slew Rate Priority. High Speed Priority will use the fastest slew rate for the instrument while Slew Rate Priority will use a user-configured slew rate

Background

Before setting the power supply to C.V. mode, ensure.
The output is off.
The load is connected

Steps

1. Press the Function key. The Function key will light up.

Function



2. The display should show F-01 on the top and the configuration setting for F-01 on the bottom.



3. Rotate the voltage knob to change the F setting to F-03 (V-I Mode Slew Rate Select).

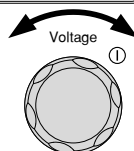

4. Use the current knob to set the F-03 setting. Set F-03 to 0 (CV High Speed Priority) or 2 (CV Slew Rate Priority).

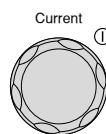

F-03 0 = CV High Speed Priority
 2 = CV Slew Rate Priority

5. Press the Voltage knob to save the configuration setting. ConF will be displayed when successful.

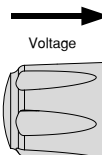

6. If CV Slew Rate Priority was chosen as the operating mode, repeat steps 3~5 to set F-04 (Rising Voltage Slew Rate) and the F-05 (Falling Voltage Slew Rate) and save.

F-04 / F-05 0.01V/s~60.00V/s (PSW -XX L30)
 0.1V/s~160.0V/s (PSW -XX L80)
 0.1V/s~320.0V/s (PSW-XX M160)
 0.1V/s~500.0V/s (PSW-XXM250)
 1V/s~1600V/s (PSW-XXH800)

7. Press the Function key again to exit the configuration settings. The function key light will turn off.

Function

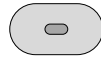

8. Use the Current knob to set the current limit (crossover point).

Current

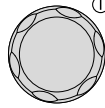

9. Use the Voltage knob to set the voltage.

Voltage

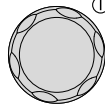

Note

Notice the Set key becomes illuminated when setting the current or voltage. If the voltage or current knobs are unresponsive, press the Set key first.

10. Press the Output key. The Output key becomes illuminated.

Output

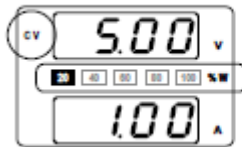

CV and the Power Bar will become illuminated (top left & center)



Note

Only the voltage level can be altered when the output is on. The current level can only be changed by pressing the Set key.





For more information on the Normal Function Settings (F-00 ~ F-61, F-88~F-89) see page 63.

2-2-3. Set to C.C. Mode

When setting the power supply to constant current mode, a voltage limit must also be set to determine the crossover point. When the voltage exceeds the crossover point, the mode switches to C.V. mode. For details about C.C. operation, see page 11. C.C. and C.V. mode have two selectable slew rates: High Speed Priority and Slew Rate Priority. High Speed Priority will use the fastest slew rate for the instrument while Slew Rate Priority will use a user-configured slew rate.

Background Before setting the power supply to C.C. mode, ensure

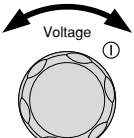
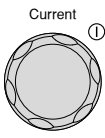
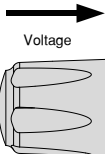
- The output is off.
- The load is connected

- | | | |
|--------------|---|---|
| Steps | <ol style="list-style-type: none"> 1. Press the Function key. The Function key will light up. | <p>Function</p>  |
| | <ol style="list-style-type: none"> 2. The display should show F-01 on the top and the configuration setting for F-01 on the bottom. |  |
| | <ol style="list-style-type: none"> 3. Rotate the voltage knob to change the F setting to F-03 (V-I Mode Slew Rate Select). |  |
| | <ol style="list-style-type: none"> 4. Use the current knob to set the F-03 setting. Set F-03 to 1 (CC High Speed Priority) or 3 (CC Slew Rate Priority) and save. |  |
| | <p>F-03 1 = CC High Speed Priority
 3 = CC Slew Rate Priority</p> <ol style="list-style-type: none"> 5. Press the Voltage knob to save the configuration setting. Conf will be displayed when successful. |  |
| |  | |
| | <ol style="list-style-type: none"> 6. If CC Slew Rate Priority was chosen as the operating mode, set F-06 (Rising Current Slew Rate) and F-07 (Falling Current Slew Rate) and save. | |

- F-06 / F-07 0.01A/s~72.00A/s (PSW-360L30)
- 0.1A/s~144.0A/s (PSW-720L30)
- 0.1A/s~216.0A/s (PSW-1080L30)
- 0.01A/s~27.00A/s (PSW-360L80)
- 0.01A/s~54.00A/s (PSW-720L80)
- 0.01A/s~81.00A/s (PSW-1080L80)
- 0.01A/s~14.40A/s (PSW-360M160)
- 0.01A/s~28.80A/s (PSW-720M160)
- 0.01A/s~43.20A/s (PSW-1080M160)
- 0.001A/s~9.000A/s (PSW-360M250)
- 0.01A/s~18.00A/s (PSW-720M250)
- 0.01A/s~27.00A/s (PSW-1080M250)
- 0.001A/s~2.880A/s (PSW-360H800)
- 0.001A/s~5.760A/s (PSW-720H800)
- 0.001A/s~8.640A/s (PSW-1080H800)

7. Press the Function key again to exit the configuration settings. The function key light will turn off.
8. Use the Voltage knob to set the voltage limit (crossover point).
9. Use the Current knob to set the current.

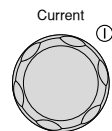
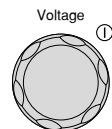
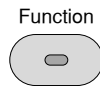

Note

Notice the Set key becomes illuminated when setting the current or voltage. If the voltage or current knobs are unresponsive, press the Set key first.

10. Press the Output key. The Output key becomes illuminated.

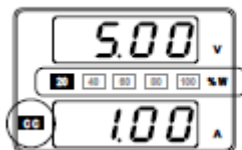
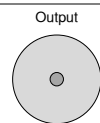

CC and the Power Bar will become illuminated (bottom left & center)



Note

Only the current level can be altered when the output is on. The voltage level can only be changed by pressing the Set key.

For more information on the Normal Function Settings (F-00 ~ F-61, F-88~F-89) see page 63.

2-2-4. Display Modes

The PSW power supplies allow you to view the output in three different modes: voltage and current, voltage and power or current and power.

- Steps
1. Press the PWR/DSPL key. The PWR DSPL key lights up. 
 2. The display changes to voltage and power (V/W).
 3. To switch between displaying A/W and V/W, simply press the corresponding voltage or current knob.
For example: when in A/W mode, press the voltage knob to display V/W. Conversely when in V/W mode, press the current knob to display A/W.

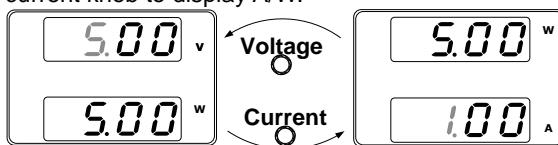

- When V/W is displayed, the voltage knob can still be used to change the voltage level.
- When A/W is displayed, the current knob can still be used to change the current level.

- Exit
- Press the PWR/DSPL key again to return to normal display mode. The PWR DSPL light will turn off. 

2-2-5. Panel Lock

The panel lock feature prevents settings from being changed accidentally. When activated, the Lock/Local key will become illuminated and all keys and knobs except the Lock/Local key and Output key (if active) will be disabled.

If the instrument is remotely controlled via the USB/LAN interface, the panel lock is automatically enabled.

- Activate the panel lock
- Press the Lock/Local key to activate the panel lock. The key will become illuminated. 

- Disable the panel lock
- Hold the Lock/Local key for ~3 seconds to disable the panel lock. The Lock/Local light turns off. 

2-2-6. Remote Sense

Remote sense is used to compensate for the voltage drop seen across load cables due to the resistance inherent in the load cables. The remote sense terminals are connected to the load terminals to determine the voltage drop across the load cables.

Remote sense can compensate up to 0.6 volts (compensation voltage). Load cables should be chosen with a voltage drop less than the compensation voltage.



WARNING

Ensure the output is off before connecting any sense cables.

Use sense cables with a voltage rating exceeding the isolation voltage of the power supply.

Never connect sensing cables when the output is on.

Electric shock or damage to the power supply could result.

The remote sensing, please wire it definitely. PSW cannot control the output when you turn on OUTPUT in the state that remote sensing was against and may damage load and PSW.



Note

Be sure to remove the Sense joining plates so the units are not using local sensing.

Single Load

1. Connect the Sense+ terminal to the positive potential of the load. Connect the Sense- terminal to the negative potential of the load.

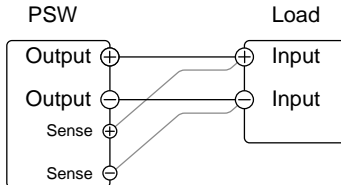

2. Operate the instrument as normal. See the Basic Operation chapter for details.

Parallel PSW Units

1. Connect the Sense+ terminals to the positive potential of the load. Connect the Sense- terminals to the negative potential of the load.

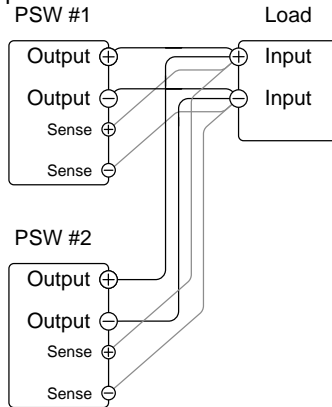

2. Operate the instrument as normal. See the Parallel Operation chapter for details.

Serial PSW Units

- a. Connect the 1st Sense+ terminal to the positive potential of the load.
- b. Connect the 1st Sense- terminal to the positive output terminal of the second PSW unit.
- c. Connect the 2nd Sense+ terminal to the positive terminal of the second PSW unit.
- d. Connect the 2nd Sense- terminal to negative terminal of the load.

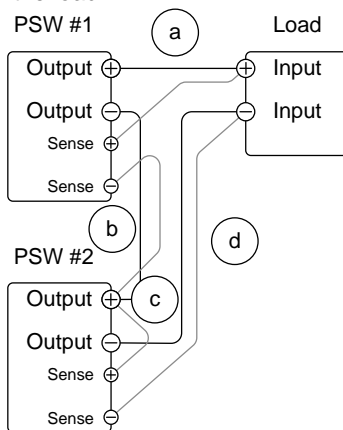

2. Operate the instrument as normal. See the Serial Operation chapter for details.

Wire Shielding and Load line impedance

To help to minimize the oscillation due to the inductance and capacitance of the load cables, use an electrolytic capacitor in parallel with the load terminals. To minimize the effect of load line impedance use twisted wire pairing.

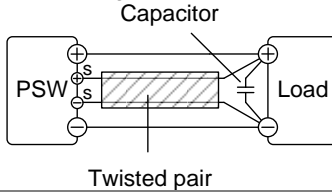

Note

The remote sensing, please wire it definitely.

2-3. Parallel / Series Operation

This section describes the basic operations required to operate the power supply in series or parallel. Operating the PSW series in parallel increases the total power output of the power supply units. When used in series, the total output voltage of the power supplies can be increased.

The number of the power supplies that can be connected in series or parallel depends on the model and the mode.

- Parallel Mode: 3 units maximum
- Series Mode: 2 units maximum (30V, 80V and 160V models only.)



CAUTION

250V and 800V models do not support series operation!

To use the power supplies in series or parallel, units must be used in a Master-Slave configuration. In the master-slave configuration a “master” power supply controls any other connected “slave” power supplies.

2-3-1. Master-Slave Parallel Overview

Background

When connecting the PSW power supplies in parallel, up to 3 units can be used in parallel and all units must be of the same model. When the units are used in parallel, a number of precautions and limitations apply. Please read this overview before operating the power supplies in parallel.

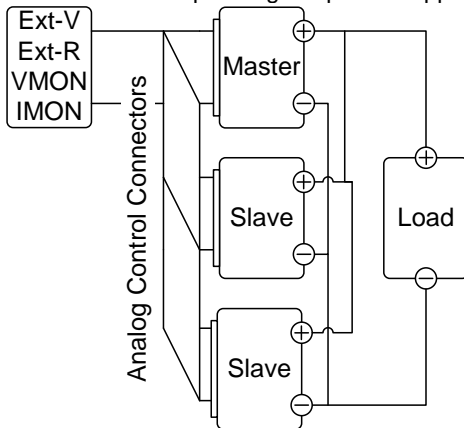

Limitations

Display

- Only the master unit will display the voltage and current.

OVP/ OCP

- The master unit can shut down slave units when OVP/OCP is tripped on the master unit (if the slave connector is wired for shut down on alarm).
- OVP/OCP can be independently tripped on each slave unit, however the shutdown of the power or output of the unit is disabled. Only the alarm will be enabled.

Remote monitoring

- Voltage monitoring (VMON) and current monitoring (IMON) are only supported on the master unit.
- The IMON current represents the total current of the all the parallelized units

Remote Sense

- Please see the remote sense chapter for details, page 38.

External Voltage and Resistance Control

- Voltage/Resistance controlled remote control can only be used with the master unit.
- The full scale current (in parallel) is equivalent to the maximum external voltage or resistance.

Internal Resistance

- For 2 units in parallel, the internal resistance is actually half of the setting value.
- For 3 units in parallel, the internal resistance is actually a third of the setting value.

Bleeder Control

• The Master unit is used to control the bleeder settings. The bleeder resistors in all the slave units are always turned off when in parallel mode.

Output Voltage/ Output Current	Model	Single	2 Unit	3 Unit
	PSW-360L30	30V	30V	30V
		36A	72A	108A
	PSW-360L80	80V	80V	80V
		13.5A	27A	40.5A
	PSW-360M160	160V	160V	160V
		7.2A	14.4A	21.6A
	PSW-360M250	250V	250V	250V
		4.5A	9.0A	13.5A
	PSW-360H800	800V	800V	800V
		1.44A	2.88A	4.32A
	PSW-720L30	30V	30V	30V
		72A	144A	216A
	PSW-720L80	80V	80V	80V
		27A	54A	81A
	PSW-720M160	160V	160V	160V
		14.4A	28.8A	43.2A
	PSW-720M250	250V	250V	250V
		9.0A	18.0A	27.0A
	PSW-720H800	800V	800V	800V
		2.88A	5.76A	8.64A
	PSW-1080L30	30V	30V	30V
		108A	216A	324A
	PSW-1080L80	80V	80V	80V
		40.5A	81A	121.5A
	PSW-1080M160	160V	160V	160V
		21.6A	43.2A	64.8A
	PSW-1080M250	250V	250V	250V
		13.5A	27.0A	40.5A
	PSW-1080H800	800V	800V	800V
		4.32A	8.64A	12.96A

2-3-2. Master-Slave Parallel Connection

Master-Slave
Connector

The Analog Control Connector is used for both serial and parallel connections. The way the connector is configured determines the behavior of the master and slave units. For the complete connector pin assignment, see page 65.

Analog Connector
Connection

To operate the power supplies in parallel, connect the analog connectors on the master and slave units as shown in the diagrams below.

Master with 2 slave units

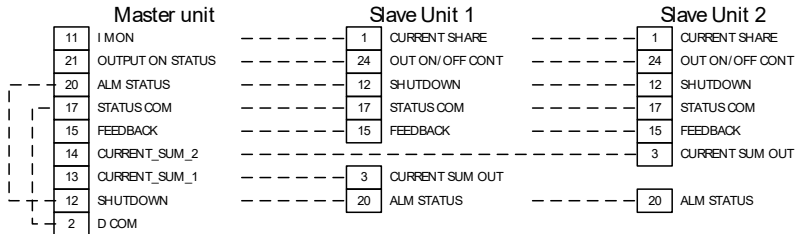
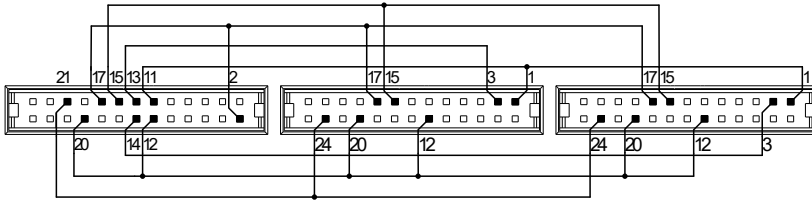

Master with 1 slave unit:

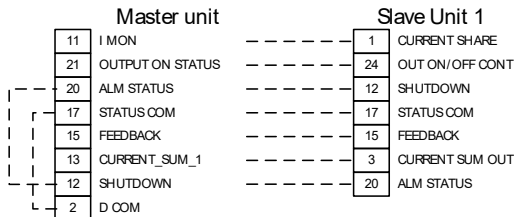
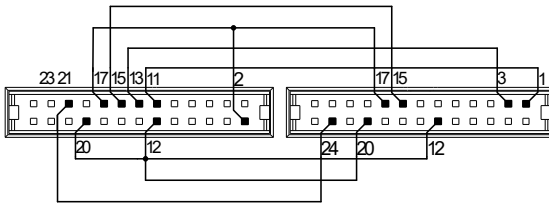

Parallel Output Connection

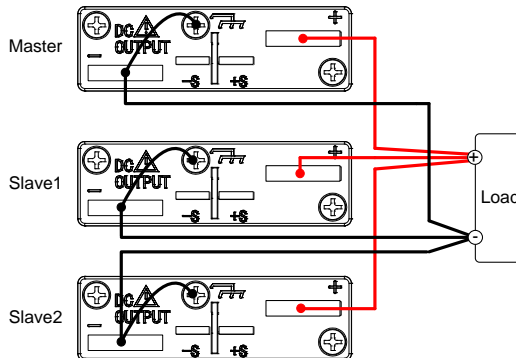

-
- Steps
1. Ensure the power is off on all power supplies.
 2. Choose a master and a slave unit(s).
 3. Connect the analog connectors for the master and slave unit as shown above.
 4. Remove the Output Terminal covers and the protection dummy plug from the analog control connector.
 5. Connect the master and slave unit in parallel as shown above.
 6. Reattach the terminal covers.
-



Note

Ensure the load cables have sufficient current capacity.
Re-attach the Protection dummy plug when not in use.

2-3-3. Master-Slave Parallel Operation

Master-Slave
Configuration

Before using the power supplies in parallel, the master and slave units need to be configured.

Steps

1. Configure the OVP and OCP settings for the master unit.
2. For each unit, hold the Function key while turning the power on to enter the power on configuration settings.

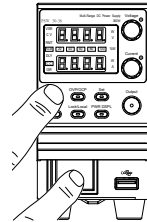

3. Configure F-93 (Master/Slave) setting for each master/slave unit

Unit	F-93
Master (with 1 slave in parallel)	1
Master (with 2 slaves in parallel)	2
Slave unit (parallel slave)	3

4. Press the Voltage knob to save configuration setting.
 5. Cycle the power on the units (reset the power).
-



Note

Configuration settings can be checked for both the master and slave units by pressing the Function key and checking F-93. Only the Master OVP and OCP level is used for over voltage and current protection. Slave OVP and OCP level is disregarded.
OTP/OHP works independently for each unit.

Master-Slave
Operation

Only operate the power supplies in parallel if the units are configured correctly.

1. Turn on the master and slave units. The slave unit(s) will show a blank display.

Master unit

Slave unit

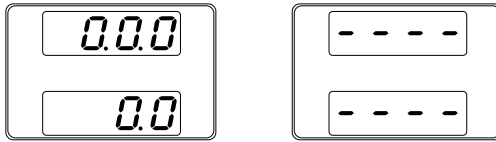

2. Operation of all units is controlled via the master unit. Operation of the master unit is the same as for a single unit. See the Basic Operation chapter.
3. Press the Output key to begin.

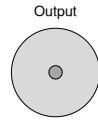

Note

Only operate the power supplies in parallel if using units of the same model number.
Only a maximum of 3 units can be used in parallel.



Note

The panel controls are disabled on slave units, including the output key. On slave units only the Function key can be used to view the current settings.

2-3-4. Master-Slave Series Overview

Background

When connecting PSW power supplies in series, up to 2 units can be used in series and all units must be of the same model.

When the units are used in series, a number of precautions and limitations apply. Please read this overview before operating the power supplies in series.



CAUTION

*250V and 800V models do not support series operation!

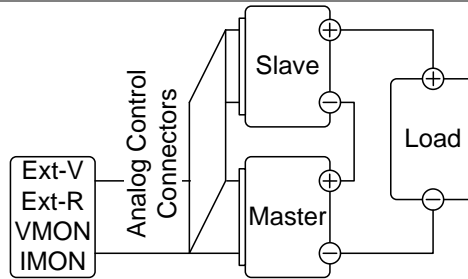

Limitations

Display

- Only the master unit will display the current.
- Master and slave units display the voltage. The total voltage is the sum of the units.

OVP/OCP

- The master unit can shut down the slave unit when OVP/OCP is tripped on the master unit (if the slave connector is wired for shut down on alarm).

- OVP and OCP level is determined by the master OVP and OCP level. The OVP and OCP level on the slave unit is ignored.

Remote monitoring

- Voltage monitoring (VMON) and current monitoring (IMON) are only supported on the master unit.
- The VMON voltage represents the total voltage of the all the serialized units.

Remote Sense

- Please see the remote sense chapter for details, page 38.

External Voltage and Resistance Control

- Voltage/Resistance controlled remote control can only be used with the master unit.
- The full scale voltage (in series) is equivalent to the maximum external voltage or resistance.

Slew Rate

- The actual slew rate is double that of the setting slew rate. I.e., A slew rate setting of 60.00V/s is actually 120V/s when in series.

Internal Resistance

- The internal resistance is actually twice that of the setting value.

Bleeder Control

- The Master unit is used to control the bleeder settings. The bleeder resistor is always turned on for the slave unit in series mode.

Output Voltage/ Output Current	Model	Single unit	2 unit
	PSW-360L30	30V 36A	60V 36A
	PSW-360L80	80V 13.5	160V 13.5A
	PSW-360M160	160V 7.2A	320V 7.2A
	PSW-720L30	30V 72A	60V 72A
	PSW-720L80	80V 27A	160V 27A
	PSW-720M160	160V 14.4A	320V 14.4A
	PSW-1080L30	30V 108A	60V 108A
	PSW-1080L80	80V 40.5A	160V 40.5A
	PSW-1080M160	160V 21.6A	320V 21.6A

2-3-5. Master-Slave Series Connection

Master-Slave Connector

The Analog Control Connector is used for both serial and parallel connections. The way the connector is configured determines the behavior of the master and slave units. For the connector pin assignment, see page 65.

Analog Connector Connection

To operate the power supplies in series, connect the analog connectors on the master and slave unit as shown in the diagram below.

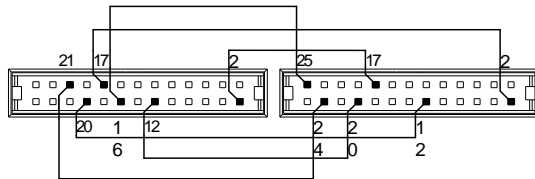

Master		Slave		
16	A COM	---	25	SER SLV IN
21	OUTPUT ON STATUS	---	24	OUT OFF/ON CONT
20	ALM STATUS	---	12	SHUTDOWN
17	STATUS COM	---	2	D COM
12	SHUTDOWN	---	20	ALM STATUS
2	D COM	---	17	STATUS COM

Series Output Connection

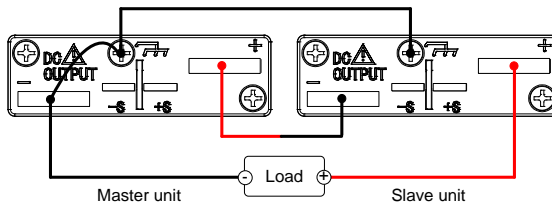

Steps

1. Ensure the power is off on both power supplies.
2. Choose a master and slave unit.
3. Connect the analog connectors for the master and slave unit as shown above.
4. Remove the output terminal cover and the protection dummy plug from the analog control connector.
5. Connect the master and slave unit in series as shown above.
6. Reattach the terminal cover.



Note

Ensure load cables have sufficient current capacity.
Re-attach the protection dummy plug when not in use.

2-3-6. Master-Slave Series Operation

Master-Slave
Configuration

Before using the power supplies in series, the master and slave units need to be configured.

1. Configure the OVP and OCP settings for the master unit.
2. For each unit, hold the Function key while turning the power on to enter the power on

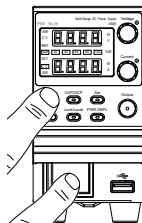

3. Configure F-93 (Master/Slave) setting for each master/slave unit.

Unit	F-93
Master (local or series operation)	0
Slave unit (series)	4

4. Press the Voltage knob to save configuration setting.
5. Cycle the power on the units (reset the power).



Note

Master-Slave
Operation

Configuration settings can be checked for both the master and slave units by pressing the Function key.

Only operate the power supplies in series if the units are configured correctly.

1. Turn on the master and slave unit. The slave unit will only show the voltage of its own unit. The master unit will show the combined voltage of both units and the current.

Master unit	Slave unit

2. Operation of all units is controlled via the master unit. Operation of the master unit is the same as for a single unit. Please see the basic operation chapter for details.
3. Press the Output key to begin.

Output



CAUTION

Only operate the power supplies in series if using units of the same model number.
Only a maximum of 2 units can be used in series.



Note

The panel controls are disabled on slave units, including the output key.

2-4. Test Script

This section describes how to use the Test function to run, load and save test scripts for automated testing. The Test function is useful if you want to perform a number of tests automatically. The PSW test function can store ten test scripts in memory.

The test data can be read from a USB drive device that you created in CSV format. Please use it in the state that you deleted files other than test.

2-4-1. Filename of TestScript

The test files are saved in csv file format.
 Each file is saved as tXXX.csv, where XXX is the save file number 001~010.
 Please copy from the CD binary file of "tst" extension with the same file name.
 It becomes the test set of data in two files.

2-4-2. Test Script Settings

RUN	Runs the chosen test script from the internal memory. The script will run by "OUTPUT" key.	T-01	1~10
Load (USB→PSW)	Loads a test script from the USB drive to the designated save slot in memory. A script must first be loaded into internal memory before it can be run.	T-02	1~10
Export (PSW→USB)	Exports a script from the designated memory save slot to the USB drive.	T-03	1~10
Remove	Deletes the chosen test file from the PSW internal memory.	T-04	1~10
Test Memory	Display remaining capacity of the PSW internal memory.	T-05	1~1852 (kByte)

2-4-3. Setting the Test Script

Steps

The test script settings (T-01~T-05) are set with the Test key.

1. Press the Test key. The Test key will light up.



2. The display will show T-01 on the top and the memory no. for T-01 on the bottom. Number that test data is displayed in front of the "Y" memory number, "N" will be displayed if it is not.

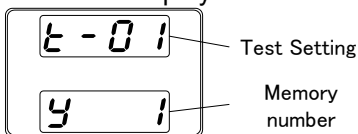

3. Rotate the voltage knob to change the T setting (Test setting).

RUN	T-01
Load	T-02
Export	T-03
Remove	T-04
Test Memory	T-05

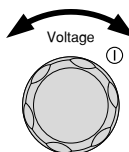

4. Rotate the current knob to choose a memory number.

memory number 1~10

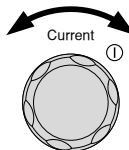

5. Press the Voltage knob to complete the setting.

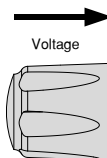

Exit Test Script

Press the Test key again to exit the Test settings. The Test key light will turn off



2-4-4. Load Test Script from USB drive

Overview Before a test script can be run, it must first be loaded into a one of the 10 memory save slots. Before loading a test script into memory:

- Ensure the script file is placed in the root directory.
- Ensure the file name number corresponds to the memory number that you wish to save to.

For example: A test file named t001.tst can only be saved to memory number 01, t002.tst can only be saved to memory number 02, and so on.

Steps

1. Insert a USB flash drive into the front panel USB-A slot. Ensure the flash drive contains a test script in the root directory.
2. Turn on the power. MS (Mass Storage) will be displayed on the screen after a few seconds if the USB drive is recognized.

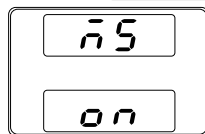
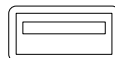

Note

If the USB drive is not recognized, check to see that the function settings for F-20 = 1 (page 60). If not, reinsert the USB flash drive.

3. Configure T-02 (Test Load) to 1~10
T-02 1~10 (t001 ~t010)
Memory number
4. The script will now be available in the memory slot the script was saved to.



Note

Error messages: If you load a file that is not present on the USB drive "Err 002" will be displayed on the display.

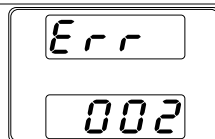

2-4-5. Run Test Script

Overview A test script can be run from one of ten memory slots.

Steps

1. Before a test script can be run, it must first be loaded into one of the 10 memory save slots. Please check the left edge of the memory number display from becoming "Y".
2. Configure T-01 (Run Test) to 1~10
T-01 1~10
Memory number
3. Press the Voltage knob to select the memory number.
LOAD:Loading the script
WAIT:Loading complete.,Test key is blinking.
Press the OUTPUT key to run the test script from the step1.

LOAD

WAIT

4. Suspend by pressing the OUTPUT key again. Then run from STEP1 Press the OUTPUT button.



Note

Error messages: If you try to run a test script from an empty memory location "Err 003" will be displayed on the display.

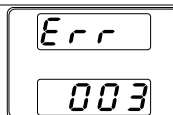

2-4-6. Run Test Script (At Startup)

Overview The power supply can be configured to automatically run a test script at startup.

- Steps**
1. Enter the power-on configuration settings and set F-92 to run the desired test script (T001~T010).
 2. The selected test script will automatically start to run the next time the unit is powered on.

2-4-7. Export Test Script to USB

Overview The Export Test function saves a test file to the root directory of a USB flash drive.

- Files will be saved as tXXX.csv where XXX is the memory number 001~010 from which the test script was exported from.
- Files of the same name on the USB flash drive will be written over.

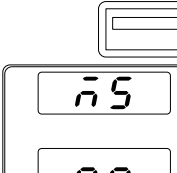
- Steps**
1. Insert a USB flash drive into the front panel USB-A slot. 
 2. Turn on the power. MS (Mass Storage) will be displayed on the screen after a few seconds if the USB drive is recognized. 



Note

If the USB drive is not recognized, check to see that the function settings for F-20 = 1 (page 60). If not, reinsert the USB flash drive.

3. Configure T-03 (Test Export) to 0~10 (save memory slot)
T-03 1~10
Memory number
4. The script will now be copied to the USB flash drive.



Note

Error messages: If you try to export a test script from an empty memory location "Err 003" will be displayed on the display.

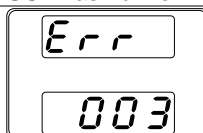

2-4-8. Remove Test Script

Overview The Remove Test function will delete a test script from the internal memory.

- Steps
1. Select T-04 (Test Remove) and choose which test script to remove from the internal memory.
T-04 1~10
Memory number
 2. The test script will be removed from the internal memory.
-



Note

Error messages: If you try to remove a test script from an empty memory location "Err 003" will be displayed on the display.

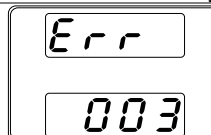

2-4-9. Test Memory

Overview Display remaining capacity of the PSW internal memory.

- Steps
1. Select T-05 (Test memory)
T-05 1~1852 (kByte)
Test Memory
This function is display only.

2-4-10. Data structure of the test Script

Test consists of two files. Extension requires both binary files and text data tst of csv.

Editing of test data in the text edit in the editor Excel or CSV file.

If you do all of the previous line, you can omit the item. Please note that you can not omit only step1.

The line will not be interpreted to describe "memo" in the first column.

It does not change the contents of the "tst" file.

Please use it to copy from the User Manual CD for 10 files (t001.tst ~ t010.tst).

Sample file

	A	B	C	D	E	F	G	H	I	J	K	L	M	N
1	memo	PSW_T002.csv												
2	DisplayItems	PI												
3	Cycle	3	5	8										
4	Step	Point	Output	Time(sec)	Voltage (V)	Current (A)	OVP(V)	OCF(A)	Bleader	I-V Mode	Vsr u(V/s)	Vsr d(V/s)	Isr u(A/s)	Isr d(A/s)
5	1	Start	ON	1.0	3.0	1.0	MAX	MAX	ON	CVHS	MAX	MAX	MAX	MAX
6	2		ON	1.5	3.5	1.0								
7	3		ON	2.0	4.0	1.0								
8	4		ON	2.5	4.5	1.0								
9	5		ON	3.0	5.0	1.0								
10	6		ON	3.5	5.5	1.0								
11	7		ON	4.0	6.0	1.0								
12	8		ON	4.5	6.5	1.0								
13	9		ON	2.0	7.0	1.0								
14	10	END	OFF	2.0	7.5	1.0								
15														

```
memo,PSW_T002.csv,,,,,,,,,,,,,
DisplayItems,PI,,,,,,,,,,,,,
Cycle,3,5,8,,,,,,,,,,,,,
Step,Point,Output,sec,Voltage (V),Current (A),OVP (V),OCF (A),Bleader,
I-V Mode,Vsr u (V/s),Vsr d (V/s),Isr u (A/s),Isr d (A/s)
1,Start,ON,1,3,1,MAX,MAX,ON,CVHS,MAX,MAX,MAX,MAX
2,,ON,1.5,3.5,1,,,,,,,,,,,,,
3,,ON,2,4,1,,,,,,,,,,,,,
4,,ON,2.5,4.5,1,,,,,,,,,,,,,
5,,ON,3,5,1,,,,,,,,,,,,,
6,,ON,3.5,5.5,1,,,,,,,,,,,,,
7,,ON,4,6,1,,,,,,,,,,,,,
8,,ON,4.5,6.5,1,,,,,,,,,,,,,
9,,ON,2,7,1,,,,,,,,,,,,,
10,END,OFF,2,7.5,1,,,,,,,,,,,,,
```

2-4-11. Setting values of the test Script

Title	unit	value
CYCLE Setting(mandatory)		Set "CYCLE"
Loop Count		0(infinity)/1 ~ 1000000000
Loop Start		1 ~ 19999
Loop End		2 ~ 20000
DisplayItem setting		Set "DisplayItems"
Item		VI Voltage / Current PI Power / Current VP Voltage / Power
Setting Values	Unit	Value
Step(mandatory)		Title / Number
Point(mandatory)		START: 1 Mid: Blank END: Last Point
OUTPUT(mandatory)		ON/OFF
Holding time(mandatory)	sec	0, 0.05 ~ 1000000.00 Resolution: 0.01 sec 0: Skip the execution (Time error occurs total time lag will occur Skip.)
Voltage	V	Value or MAX/MIN (See ratings)
Current	A	Value or MAX/MIN (See ratings)
OVP	V	Value or MAX/MIN (See ratings)
OCP	A	Value or MAX/MIN (See ratings)
Bleeder		ON/OFF
V-I Mode		CVHS: CV High speed priority CCHS: CC High speed priority CVLS: CV slew rate priority CCLS: CC slew rate priority
V Slew Rate up	V/s	Value or MAX/MIN (See ratings)
V Slew Rate down	V/s	Value or MAX/MIN (See ratings)
A Slew Rate up	A/s	Value or MAX/MIN (See ratings)
A Slew Rate down	A/s	Value or MAX/MIN (See ratings)

Set of items that are not mandatory, you can omit the input when the same content as the previous step. Please delete any line blank.

The number of steps is limited to free memory area, but it is up to step up to 20000.

Setting of time is 0.01 seconds resolution, 0.05 seconds in the shortest.

You must be careful follow-up of the setting so constrained by the setting and load conditions. The 0 second setting may not be possible depending on the version.

3 CONFIGURATION

Configuration of the PSW power supplies is divided into five different configuration settings: Normal Function, USB/GP-IB, LAN, Power ON Configuration, Calibration Settings and System Settings. Power ON Configuration differs from the other settings in that the settings used with Power ON Configuration settings can only be set during power up. The other configuration settings can be changed when the unit is already on. This prevents some important configuration parameters from being changed inadvertently. Power ON Configuration settings are numbered F-90 to F-95 and the other configuration settings are numbered F-00 to F-61 and F-88 to F-89.

3-1. Configuration Table

Please use the configuration settings listed below when applying the configuration settings.

Normal Functionsetting	Settings	Setting range
Output ON delay time	F-01	0.00s~99.99s
Output OFF delay time	F-02	0.00s~99.99s
V-I mode slew rate select	F-03	0 = CV high speed priority 1 = CC high speed priority 2 = CV slew rate priority 3 = CC slew rate priority
Rising voltage slew rate	F-04	0.01V/s~60.00V/s (PSW-XXL30) 0.1V/s~160.0V/s (PSW-XXL80) 0.1V/s~320.0V/s (PSW-XXM160) 0.1V/s~500.0V/s (PSW-XXM250) 1V/s ~1600V/s (PSW-XXH800)
Falling voltage slew rate	F-05	0.01V/s~60.00V/s (PSW-XXL30) 0.1V/s~160.0V/s (PSW-XXL80) 0.1V/s~320.0V/s (PSW-XXM160) 0.1V/s~500.0V/s (PSW-XXM250) 1V/s ~1600V/s (PSW-XXH800)
Rising current slew rate	F-06	0.01A/s~72.00A/s (PSW-360L30) 0.1A/s~144.0A/s (PSW-720L30) 0.1A/s~216.0A/s (PSW-1080L30) 0.01A/s~27.00A/s (PSW-360L80) 0.01A/s~54.00A/s (PSW-720L80) 0.01A/s~81.00A/s (PSW-1080L80) 0.01A/s~14.40A/s (PSW-360M160) 0.01A/s~28.80A/s (PSW-720M160) 0.01A/s~43.20A/s (PSW-1080M160) 0.001A/s ~ 9.000A/s (PSW-360M250) 0.01A/s ~ 18.00A/s (PSW-720M250) 0.01A/s ~ 27.00A/s (PSW-1080M250) 0.001A/s ~ 2.880A/s (PSW-360H800) 0.001A/s ~ 5.760A/s (PSW-720H800) 0.001A/s ~ 8.640A/s (PSW-1080H800)

Falling current slew rate	F-07	0.01A/s~72.00A/s (PSW-360L30) 0.1A/s~144.0A/s (PSW-720L30) 0.1A/s~216.0A/s (PSW-1080L30) 0.01A/s~27.00A/s (PSW-360L80) 0.01A/s~54.00A/s (PSW-720L80) 0.01A/s~81.00A/s (PSW-1080L80) 0.01A/s~14.40A/s (PSW-360M160) 0.01A/s~28.80A/s (PSW-720M160) 0.01A/s~43.20A/s (PSW-1080M160) 0.001A/s ~ 9.000A/s (PSW-360M250) 0.01A/s ~ 18.00A/s (PSW-720M250) 0.01A/s ~ 27.00A/s (PSW-1080M250) 0.001A/s ~ 2.880A/s (PSW-360H800) 0.001A/s ~ 5.760A/s (PSW-720H800) 0.001A/s ~ 8.640A/s (PSW-1080H800)
Internal resistance setting	F-08	0.000Ω~0.833Ω (PSW-360L30) 0.000Ω~0.417Ω (PSW-720L30) 0.000Ω~0.278Ω (PSW-1080L30) 0.000Ω~5.926Ω (PSW-360L80) 0.000Ω~2.963Ω (PSW-720L80) 0.000Ω~1.975Ω (PSW-1080L80) 0.000Ω~22.222Ω (PSW-360M160) 0.000Ω~11.111Ω (PSW-720M160) 0.000Ω~7.407Ω (PSW-1080M160) 0.00Ω ~ 55.55Ω (PSW-360M250) 0.00Ω ~ 27.77Ω (PSW-720M250) 0.00Ω ~ 18.51Ω (PSW-1080M250) 0.0Ω ~ 555.5Ω (PSW-360H800) 0.0Ω ~ 277.8Ω (PSW-720H800) 0.0Ω ~ 185.1Ω (PSW-1080H800)
Bleeder circuit control	F-09	0 = OFF, 1 = ON, 2 = AUTO
Buzzer ON/OFF control	F-10	0 = OFF, 1 = ON
Measurement Average Setting	F-17	0 = Low, 1 = Middle, 2 = High
Lock Mode	F-19	0 = Panel lock: allow output off 1 = Panel lock: allow output on/off
USB/GP-IB settings		
Front panel USB State*	F-20	0 = Absent, 1 = Mass Storage
Rear panel USB State*	F-21	0 = Absent, 2 = USB-CDC, 3 = GPIB adapter,5 = RS-232C adapter
Rear panel USB mode	F-22	0 = Disable, 1 = I/F adaptor, 2 = USB CDC, 3 = USB CDC(Full Speed)
GP-IB address	F-23	0~30
LAN Settings		
MAC address-1*	F-30	0x00~0xFF
MAC address-2*	F-31	0x00~0xFF
MAC address-3*	F-32	0x00~0xFF
MAC address-4*	F-33	0x00~0xFF
MAC address-5*	F-34	0x00~0xFF

MAC address-6*	F-35	0x00~0xFF
LAN	F-36	0 = Disable, 1 = Enable
DHCP	F-37	0 = Disable, 1 = Enable
IP address-1	F-39	0~255
IP address-2	F-40	0~255
IP address-3	F-41	0~255
IP address-4	F-42	0~255
Subnet Mask-1	F-43	0~255
Subnet Mask-2	F-44	0~255
Subnet Mask-3	F-45	0~255
Subnet Mask-4	F-46	0~255
Gateway-1	F-47	0~255
Gateway-2	F-48	0~255
Gateway-3	F-49	0~255
Gateway-4	F-50	0~255
DNS address -1	F-51	0~255
DNS address -2	F-52	0~255
DNS address -3	F-53	0~255
DNS address -4	F-54	0~255
Sockets active	F-57	0 = Disable, 1 = Enable
Web Server active	F-59	0 = Disable, 1 = Enable
Web password active	F-60	0 = Disable, 1 = Enable
Web setting password	F-61	0000~9999
RS-232C(GUR-001/GUR-001A)		
Baudrate	F-71	0(1200bps)~7(115200bps)
Data length	F-72	0(7bit), 1(8bit)
Parity	F-73	0(none), 1(odd), 2(even)
Stop bit	F-74	0(1bit), 1(2bit)
System Settings		
Factory Set Value	F-88	0 = Disable 1 = Return to factory settings
Show Version	F-89	0, 1 = PSW version 2, 3 = PSW build year 4, 5 = PSW build month/day 6, 7 = Keyboard CPLD version 8, 9 = Analog-Control CPLD version A, B = Reserved C, D = Kernel build year E, F = Kernel build month/day G, H = Test command version I, J = Test command build year K, L = Test command build month/day M, N = USB Driver version

Power On Configuration Settings*		
CV Control	F-90	0 = Panel control (local) 1 = External voltage control 2 = External resistance control (Ext-R 10kΩ = Vo, max) 3 = External resistance control (Ext-R10kΩ = 0)
CC Control	F-91	0 = Panel control (local) 1 = External voltage control 2 = External resistance control (Ext-R 10kΩ = Io,max) 3 = External resistance control (Ext-R10kΩ = 0)
Power-ON Output	F-92	0 = OFF at startup, 1 = On at startup t001 ~ t010 = run testscript t001 ~ t010
Master/Slave	F-93	0 = Master/Local 1 = Master/Parallel1 2 = Master/Parallel2 3 = Slave/Parallel 4 = Slave/Series(30V,80V,160V models)
External Out Logic	F-94	0 = High ON, 1 = Low ON
Power Switch trip	F-95	0 = Enable, 1 = Disable
Calibration Settings*		
Calibration	F-00	0000 ~ 9999



Note

Power On and Calibration settings can only be set during power up.

3-2. Normal Function Settings

Output ON Delay
Time

Delays turning the output on for a designated amount of time. The Delay indicator will light when the Delay time is not 0.

Note: The Output ON Delay Time setting has a maximum deviation (error) of 20ms. The Output ON Delay Time setting is disabled when the output is set to external control.

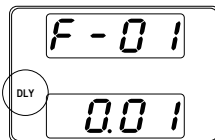

F-01

0.00s~99.99s

Output OFF Delay Time Delays turning the output off for a designated amount of time. The Delay indicator will light when the Delay time is not 0
 Note: The Output OFF Delay Time setting has a maximum deviation (error) of 20ms. The Output OFF Delay Time setting is disabled when the output is set to external control.



F-02 0.00s~99.99s

V-I Mode Selects High Speed Priority or Slew Rate Priority for CV or CC mode. The voltage or current slew rate can only be edited if CC/CV Slew Rate Priority is selected. The ISR indicator will be lit for CC Slew Rate Priority and the VSR indicator will be lit for CV Slew Rate Priority.
 Note: CC and CV Slew Rate Priority mode are disabled when voltage/current output is set to external control.

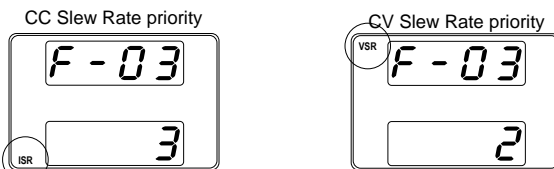

F-03 0 = CV high speed priority
 1 = CC high speed priority
 2 = CV slew rate priority
 3 = CC slew rate priority

Rising Voltage Slew Rate Sets the rising voltage slew rate. Only applicable if V-I Mode is set to CV Slew Rate Priority.
 F-04 0.01V/s~60.00V/s (PSW-XXL30)
 0.1V/s~160.0V/s (PSW-XXL80)
 0.1V/s~320.0V/s (PSW-XXM160)
 0.1V/s~500.0V/s (PSW-XXM250)
 1V/s ~1600V/s (PSW-XXH800)

Falling Voltage Slew Rate Sets the falling voltage slew rate. Only applicable if V-I Mode is set to CV Slew Rate Priority.
 F-05 0.01V/s~60.00V/s (PSW-XXL30)
 0.1V/s~160.0V/s (PSW-XXL80)
 0.1V/s~320.0V/s (PSW-XXM160)
 0.1V/s~500.0V/s (PSW-XXM250)
 1V/s ~1600V/s (PSW-XXH800)

Rising Current Slew Rate Sets the rising current slew rate. Only applicable if V-I Mode is set to CC Slew Rate Priority.

	F-06	0.01A/s~72.00A/s (PSW-360L30) 0.1A/s~144.0A/s (PSW-720L30) 0.1A/s~216.0A/s (PSW-1080L30) 0.01A/s~27.00A/s (PSW-360L80) 0.01A/s~54.00A/s (PSW-720L80) 0.01A/s~81.00A/s (PSW-1080L80) 0.01A/s~14.40A/s (PSW-360M160) 0.01A/s~28.80A/s (PSW-720M160) 0.01A/s~43.20A/s (PSW-1080M160) 0.001A/s ~ 9.000A/s (PSW-360M250) 0.01A/s ~ 18.00A/s (PSW-720M250) 0.01A/s ~ 27.00A/s (PSW-1080M250) 0.001A/s ~ 2.880A/s (PSW-360H800) 0.001A/s ~ 5.760A/s (PSW-720H800) 0.001A/s ~ 8.640A/s (PSW-1080H800)
Falling Current Slew Rate	Sets the falling current slew rate. Only applicable if V-I Mode is set to CC Slew Rate Priority. F-07	0.01A/s~72.00A/s (PSW-360L30) 0.1A/s~144.0A/s (PSW-720L30) 0.1A/s~216.0A/s (PSW-1080L30) 0.01A/s~27.00A/s (PSW-360L80) 0.01A/s~54.00A/s (PSW-720L80) 0.01A/s~81.00A/s (PSW-1080L80) 0.01A/s~14.40A/s (PSW-360M160) 0.01A/s~28.80A/s (PSW-720M160) 0.01A/s~43.20A/s (PSW-1080M160) 0.001A/s ~ 9.000A/s (PSW-360M250) 0.01A/s ~ 18.00A/s (PSW-720M250) 0.01A/s ~ 27.00A/s (PSW-1080M250) 0.001A/s ~ 2.880A/s (PSW-360H800) 0.001A/s ~ 5.760A/s (PSW-720H800) 0.001A/s ~ 8.640A/s (PSW-1080H800)
Internal Resistance Settings	Sets the internal resistance of the power supply F-08	0.000Ω~0.833Ω (PSW-360L30) 0.000Ω~0.417Ω (PSW-720L30) 0.000Ω~0.278Ω (PSW-1080L30) 0.000Ω~5.926Ω (PSW-360L80) 0.000Ω~2.963Ω (PSW-720L80) 0.000Ω~1.975Ω (PSW-1080L80) 0.000Ω~22.222Ω (PSW-360M160) 0.000Ω~11.111Ω (PSW-720M160) 0.000Ω~7.407Ω (PSW-1080M160) 0.00Ω ~ 55.55Ω (PSW-360M250) 0.00Ω ~ 27.77Ω (PSW-720M250) 0.00Ω ~ 18.51Ω (PSW-1080M250) 0.0Ω ~ 555.5Ω (PSW-360H800) 0.0Ω ~ 277.8Ω (PSW-720H800) 0.0Ω ~ 185.1Ω (PSW-1080H800)

Bleeder Control	Bleeder control turns ON/OFF the bleeder resistor. When set to AUTO the bleeder resistor is automatically turned on when the output is turned on and turned off when the output is turned off. Bleeder resistors discharge the filter capacitors after power is turned off as a safety measure. The AUTO setting is only applicable to firmware version 1.59 or above. F-09 0 = OFF, 1 = ON, 2 = AUTO
Buzzer ON/OFF	Turns the buzzer sound on or off. The buzzer is associated with alarm sounds and keypad entry sounds. F-10 0 = OFF, 1 = ON
Measurement Average Settings	Determines the level of smoothing for the average setting Only available for firmware version 1.5 or above. F-17 0 = Low, 1 = Middle, 2 = High
Lock Mode	Determines the behavior of the Output key when the panel lock is on. Only available for firmware version 1.54 or above. F-19 0 = Panel lock: allow output off 1 = Panel lock: allow output on/off

3-3. USB/GP-IB/RS-232C Settings

Front Panel USB State	Displays the front panel USB-A port state. This setting is not configurable. F-20 0 = Absent, 1 = Mass Storage
Rear Panel USB State	Displays the rear panel USB-B port state. This setting is not configurable. F-21 0 = Absent, 2 = USB-CDC, 3 = GPIB adapter, 5 = RS-232C adapter
Rear Panel USB Mode	Sets the rear panel USB mode. F-22 0 = Disable, 1 = I/F adapter, 2 = USB CDC, 3 = USB CDC(Full Speed)
GP-IB Address	Sets the GP-IB address F-23 0~30
RS-232C Baud rate	Set the RS-232C settings F-71 0(1200bps)、1(2400bps)、2(4800bps)、 3(9600bps)、4(19200bps)、5(38400bps)、 6(57400bps)、7(115200bps)
Data bit	F-72 0(7bit)、1(8bit)
Parity	F-73 0(none)、1(odd)、2(even)
Stop bit	F-74 0(1bit)、1(2bit)

3-4. LAN Settings

MAC Address 1~6	Displays the MAC address 1~6. This setting is not configurable. F-30~F-35 0x00~0xFF
-----------------	---

LAN	Turns Ethernet on or off. F-36 0 = Disable, 1 = Enable
DHCP	Turns DHCP on or off. F-37 0 = Disable, 1 = Enable
IP Address 1~4	Sets the default IP address. IP address 1~4 splits the IP address into four sections. (F-39 : F-40 : F-41 : F-42) (0~255 : 0~255 : 0~255 : 0~255)
Subnet Mask 1~4	Sets the subnet mask. The subnet mask is split into four parts. (F-43 : F-44 : F-45: F-46) (0~255 : 0~255 : 0~255 : 0~255)
Gateway 1~4	Sets the gateway address. The gateway address is split into 4 parts. (F-47 : F-48 : F-49 : F-50) (0~255 : 0~255 : 0~255 : 0~255)
DNS Address 1~4	Sets the DNS address. The DNS address is split into 4 parts. (F-51 : F-52 : F-53 : F-54) (0~255 : 0~255 : 0~255 : 0~255)
Sockets active	Enables WebSocket connections. F-57 0 = Disable, 1 = Enable
Web server active	Turns Web server control on/off. F-59 0 =Disable, 1 = Enable
Web Password active	Turns a web password on/off. F-60 0 = Enable, 1 = Disable
Web Password	Sets the Web password. F-61 0000 ~ 9999

3-5. System Settings

Factory Set Value	Returns the PSW to the factory default settings. See page 26 for a list of the default settings. (Test Script settings is not initialized.) F-88 0 = Disable, 1 = Return to factory default settings.
Show Version	Displays the PSW version number, build date, keyboard version, analog-control version, kernel build, test command version and test command build date

F-89	0, 1	= PSW version
	2, 3	= PSW build year
	4, 5	= PSW build month/day
	6, 7	= Keyboard CPLD version
	8, 9	= Analog-Control CPLD version
	A, B	= Reserved
	C, D	= Kernel build year
	E, F	= Kernel build month/day
	G, H	= Test command version
	I, J	= Test command build year
	K, L	= Test command build month/day
	M, N	= USB Driver version

3-6. Power On Configuration Settings

CV Control	Sets the constant voltage (CV) control mode between local and external voltage/resistance control. For external voltage control, see page 67 (External Voltage Control of Voltage Output) and page 70 (External Resistance Control of Voltage Output).	
F-90	0	= Panel control (local)
	1	= External voltage control
	2	= External resistance control (Ext-R 10k Ω = V_o ,max)
	3	= External resistance control (Ext-R10k Ω = 0)
CC Control	Sets the constant current (CC) control mode between local and external voltage/resistance control. For details on external voltage control, see page 68 (External Voltage Control of Current Output) and 71 (External Resistance Control of Current Output).	
F-91	0	= Panel control (local)
	1	= External voltage control
	2	= External resistance control (Ext-R 10k Ω = I_o ,max)
	3	= External resistance control (Ext-R10k Ω = 0)
Power-ON Output	Sets the power supply to turn the output on or off at power up.	
F-92	0	= OFF at startup, 1 = On at startup
	t001 ~ t010	= run testscript t001 ~ t010
Master/Slave	Sets the power supply as master or slave. See the parallel/series operation for details, page 38.	
F-93	0	= Master/Local
	1	= Master/Parallel1
	2	= Master/Parallel2
	3	= Slave/Parallel
	4	= Slave/Series(30V,80V,160V models)

External Out Logic	Sets the external logic as active high or low. F-94 0 = High ON 1 = Low ON
Power Switch Trip	Turns the power off if enabled when the protection settings are tripped. F-95 0 = Enable 1 = Disable

3-7. Calibration

Programmable Calibration	The calibration password is used to access the local mode calibration or other special functions. F-00 0000 ~ 9999
--------------------------	--

3-8. Setting Normal Function Settings

The normal function settings (F-01~F-61, F-88~F-89) can be easily configured with the Function key.

- Ensure the load is not connected.
- Ensure the output is off.



Note

Function setting F-89 (Show Version) can only be viewed, not edited.

Configuration settings F-90~F-95 cannot be edited in the Normal Function Settings. Use the Power On Configuration Settings. See page 62 for details

Steps

1. Press the Function key. The function key will light up.

Function



2. The display will show F-01 on the top and the configuration setting for F-01 on the bottom

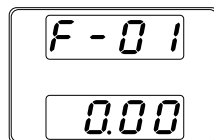

3. Rotate the voltage knob to change the F setting.

Range F-00~ F-61, F-88~F-89



Voltage ①



4. Use the current knob to set the parameter for the chosen F setting.

Current ①



- Press the Voltage knob to save the configuration setting. ConF will be displayed when successful.

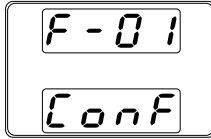
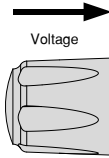

Exit

Press the Function key again to exit the configuration settings. The function key light will turn off.



3-9. Setting Power On Configuration Settings

Background

The Power On configuration settings can only be changed during power up to prevent the configuration settings being inadvertently changed.

- Ensure the load is not connected.
- Ensure the power supply is off.

Steps

- Hold the Function key whilst turning the power on.
- The display will show F-90 on the top and the configuration setting for F-90 on the bottom.

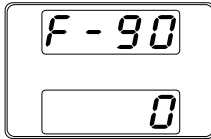
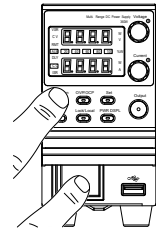

- Rotate the voltage knob to change the F setting.

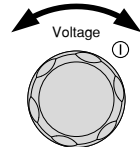

Range F-90~ F-95

- Use the current knob to set the parameter for the chosen F setting.

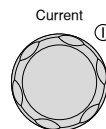

- Press the Voltage knob to save the configuration setting. ConF will be displayed when successful.

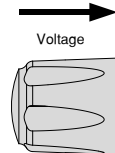

Exit

Cycle the power to save and exit the configuration settings.

4 ANALOG CONTROL

The Analog Control chapter describes how to control the voltage or current output using an external voltage or resistance, monitor the voltage or current output as well as remotely turning off the output or shutting down the power supply.

4-1. Analog Remote Control Overview

The PSW power supply series have a number of analog control options. The Analog Control connectors are used to control output voltage and current using external voltage or resistance. The power supply output and power switch can also be controlled using external switches.

4-1-1. Analog Control Connector Overview

Overview The Analog Control Connector is a standard Mil 26 pin connector (OMRON XG4C plug). Use an OMRON XG5M socket as the mating socket. The connector is used for all analog remote control. The pins used determine what remote control mode is used.



WARNING

To prevent electric shock, ensure that the cover for the Analog Control Connector is used when the connector is not in use.

Pin Assignment

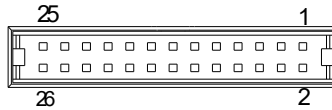

The mounting of the wire to the contact, in order to improve the reliability, please use the (OMRON) special tool XY2B-7006. In addition, the application wire rod is twist line AWG28 - AWG26, external form $\Phi 1.1\text{-}\Phi 1.3$. Specifically, please review an instruction manual of XY2B-7006. For details, please confirm the operation manual of XY2B-7006.

In the case of faulty wiring or wiring change, please use the (OMRON) special tool XY2E-0001 that is withdrawn from the housing contact. For details, please confirm the operation manual of XY2E-0001.

Pin name	Pin number	Description
Current Share	1	Used when operating 2 or more units in parallel.
D COM	2	Connected to the (-S) sense- terminal when remote sense is used. Connected to the negative output terminal when remote sense is not used.
CURRENT SUM OUT	3	Current sum output signal when used in parallel mode. The slave outputs an output electric current signal. The master adds up an output electric current.
EXT-V CV CONT	4	External voltage control of the voltage output. A voltage of 0~10V is used to control the full scale voltage output (0%~100%) of the instrument.

EXT-V CC CONT	5	External voltage control of the current output. A voltage of 0~10V is used to control the full scale current output (0%~100%)of the instrument
EXT-R CV CONT PIN1	6	External resistance control of the voltage output. A resistance of 0k Ω ~ 10k Ω is used to control the full scale
EXT-R CV CONT PIN2	7	voltage output (0%~100%) of the instrument. Use 6 pins and 7 pins pairwise.
EXT-R CC CONT PIN1	8	External resistance control of the current output. A resistance of 0k Ω ~ 10k Ω is used to control the full scale
EXT-R CC CONT PIN2	9	current output (0%~100%) of the instrument. Use 8 pins and 9 pins pairwise.
V MON	10	oltage Monitor Output. Outputs the full scale voltage (0~100%) as a voltage (0V~10V). Use 10 pins and 16 pins pairwise.
I MON	11	Current Monitor Output. Outputs the full scale current (0~100%) as a voltage (0V~10V). Use 11 pins and 16 pins pairwise.
SHUTDOWN	12	The shut down signal will turn off the output or power when a low TTL signal is applied. The shutdown signal is pulled up to 5V with a 10k Ω pull-up resistor. Use 2 pins and 12 pins pairwise.
CURRENT_ SUM_1	13	Master unit current sum input signal from first slave CURRENT SUM OUTPUT. Used in parallel mode only.
CURRENT_ SUM_2	14	Master unit current sum input signal from second slave CURRENT SUM OUTPUT. Used in parallel mode only.
FEEDBACK	15	Parallel control signal during master-slave parallel operation.
A COM	16	Analog signal common. Connected to the sense- terminal when remote sense is used. Connected to the negative output terminal when remote sense is not used.
STATUS COM	17	Common for status signals 18, 19, 20, 21 and 22.
CV STATUS	18	C Turns on when CV mode is active. (photo coupled open collector output)
CC STATUS	19	Turns on when CC mode is active. (photo coupled open collector output)
ALM STATUS	20	Turns on when any of the protection modes are tripped (OVP, OCP) or if a shutdown signal is input. (photo coupled open collector output)
OUTPUT ON STATUS	21	Turns on when the output has been turned on. (photo coupled open collector output)
POWER OFF STATUS	22	Turns on when the power switch is turned off. (photo coupled open collector output)
N.C.	23	Not connected
OUT ON/OFF CONT	24	Turns the output on/off when (default setting) a low TTL signal is applied. Internally, the circuit is pulled up to +5V with 10k Ω resistance.
SER SLV IN	25	Series slave input during master-slave series operation.
N.C.	26	Not connected

4-1-2. External Voltage Control of Voltage Output

Background

External voltage control of the voltage output is accomplished using the MIL-26 connector on the rear panel. A voltage of 0–10V is used to control the full scale voltage of the instrument, where:

Output voltage = full scale voltage × (external voltage/10)

Connection 1

When connecting the external voltage source to the MIL connectors, use shielded or twisted paired wiring.

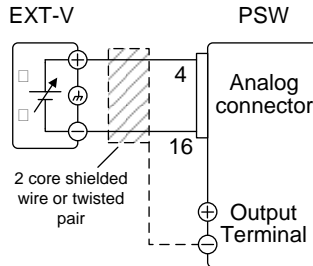

- Pin16 → EXT-V (-)
- Pin4 → EXT-V (+)
- Wire shield → negative (-) output terminal

Connection- 2
alt. shielding

If the wire shield needs to be grounded at the voltage source (EXT-V), then the shield cannot also be grounded at the negative (-) terminal output of the PSW power supply. This would short the output.

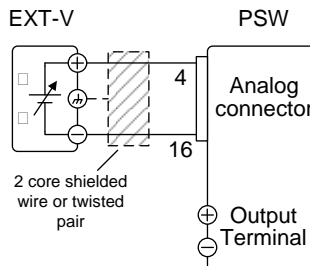

- Pin16 → EXT-V(-)
- Pin4 → EXT-V(+)
- Wire shield → EXT-V ground (GND)

Panel operation

1. Connect the external voltage according to the connection diagrams above
2. Set the F-90 power on configuration setting to 1 (CV control – Ext voltage).
 - Be sure to cycle the power after the power on configuration has been set.
3. Press the Function key and confirm the new configuration settings (F-90=1).

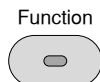

4. Press the Output key. The voltage can now be controlled with the External voltage.

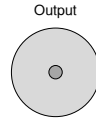

WARNING	Be careful about the grounding voltage of the outside voltage.
CAUTION	Ensure no more than 10.5 volts are input into the external voltage input. Ensure the voltage polarity is correct when connecting the external voltage.
Note	The input impedance for external voltage control is 10kΩ. Use a stable voltage supply for the external voltage control. CV and CC Slew Rate Priority are disabled for V-I mode (F-03) when using external voltage control. During outside voltage control, invalidity becomes the output on/off delay time.

4-1-3. External Voltage Control of Current Output

Background

External voltage control of the current output is accomplished using the MIL-26 connector on the rear panel. A voltage of 0~10V is used to control the full scale current of the instrument, where:

$$\text{Output current} = \text{full scale current} \times (\text{external voltage}/10)$$

Connection 1

When connecting the external voltage source to the MIL connectors, use shielded or twisted paired wiring.

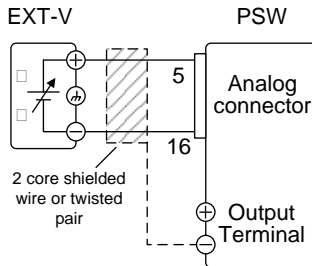

- Pin16 → EXT-V (-)
- Pin5 → EXT-V (+)
- Wire shield → negative (-) output terminal

Connection 2
alt. shielding

If the wire shield needs to be grounded at the voltage source (EXT-V), then the shield cannot also be grounded at the negative (-) terminal output of the PSW power supply. This would short the output.

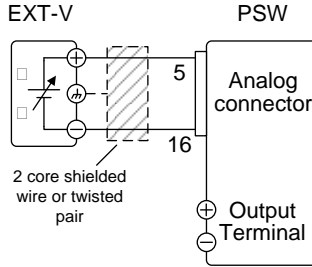

- Pin16 → EXT-V (-)
- Pin5 → EXT-V (+)
- Wire shield → EXT-V ground (GND)

Steps

1. Connect the external voltage according to the connection diagrams above.
2. Set the F-91 power on configuration setting to 1 (CC control – Ext voltage).
 - Be sure to cycle the power after the power on configuration has been set.
3. Press the Function key and confirm the new configuration settings (F-91=1).
4. Press the Output key. The current can now be controlled with the External voltage.

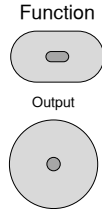

 **WARNING**

Be careful about the grounding voltage of the outside voltage.

 **CAUTION**

Ensure the voltage polarity is correct when connecting the external voltage.
Ensure no more than 10.5 volts are input into the external voltage input.

 **Note**

The input impedance for external voltage control is 10kΩ. Use a stable voltage supply for the external voltage control. CV and CC Slew Rate Priority are disabled for V-I mode (F-03) when using external voltage control. During outside voltage control, invalidity becomes the output on/off delay time.

4-1-4. External Resistance Control of Voltage Output

Background

External resistance control of the voltage output is accomplished using the MIL-26 connector on the rear panel. A resistance of $0\text{k}\Omega\sim 10\text{k}\Omega$ is used to control the full scale voltage of the instrument.

The output voltage (0 to full scale) can be controlled with the external resistance going up (Ext-R) $0\text{k}\Omega\sim 10\text{k}\Omega$ ($10\text{k}\Omega = V_{o,max}$) or down (Ext-R) $10\text{k}\Omega\sim 0\text{k}\Omega$ ($10\text{k}\Omega = 0$).

For $0\text{k}\Omega\sim 10\text{k}\Omega$:

Output voltage = full scale voltage \times (external resistance/10)

For $10\text{k}\Omega\sim 0\text{k}\Omega$:

Output voltage = full scale voltage \times [(10-external resistance)/10]



Note

The Ext-R configuration is recommended for safety reasons. In the event that the cables become accidentally disconnected, the voltage output will drop to zero. Under similar circumstances using Ext-R, an unexpected high voltage would be output.

If switches are used to switch between fixed resistances, use switches that avoid creating open circuits. Use short-circuit or continuous resistance switches.

Connection

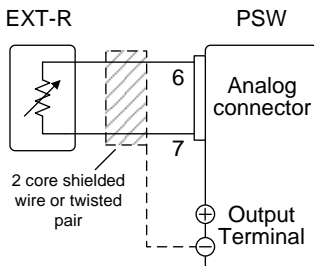

- Pin6 → EXT-R
- Pin7 → EXT-R
- Wire shield → negative (-) output terminal

Steps

1. Connect the external resistance according to the connection diagrams above.
2. Set the F-90 (CV Control) configuration settings to 2 for Ext-R or 3 for Ext-R.
 - Be sure to cycle the power after the power on configuration has been set.
3. Press the Function key and confirm the new configuration settings (F-90=2 or 3).

Function



4. Press the Output key. The voltage can now be controlled with the External resistance.

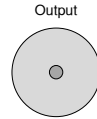

Ensure the resistor(s) and cables used exceed the isolation voltage of the power supply. For example: insulation tubes with a withstand voltage higher than the power supply can be used.



When choosing an external resistor ensure the resistor can withstand a high degree of heat.

Please connect the wiring with 2 core shielding line or twisted pair cable briefly. Please do not be affected by foreign noises.

CV and CC Slew Rate Priority are disabled for V-I mode (F-03) when using external resistance control. See the normal function settings on page 57.

During outside voltage control, invalidity becomes the output on/off delay time.

4-1-5. External Resistance Control of Current Output

Background

External resistance control of the current output is accomplished using the MIL-26 connector on the rear panel. A resistance of 0kΩ~10kΩ is used to control the full scale current of the instrument.

The output current (0 to full scale) can be controlled with the external resistance going up (Ext-R)

For 0kΩ~10kΩ:

Output current = full scale current × (external resistance/10)

For 10kΩ~0kΩ:

Output current = full scale current × ((10-external resistance)/10)



The Ext-R configuration is recommended for safety reasons. In the event that the cables become accidentally disconnected, the current output will drop to zero. Under similar circumstances using Ext-R, an unexpected high current would be output.

If switches are used to switch between fixed resistances, use switches that avoid creating open circuits. Use short-circuit or continuous resistance switches.

Connection

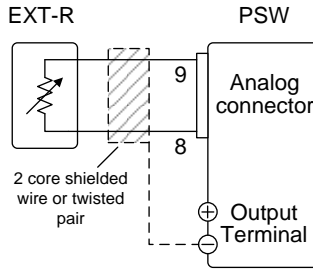

Pin9 → EXT-R

Pin8 → EXT-R

Wire shield → negative (-) output terminal

Steps

1. Connect the external resistance according to the connection diagrams above.
2. Set the F-91 (CC Control) configuration settings to 2 for Ext-R or 3 for Ext-R.
 - Be sure to cycle the power after the power on configuration has been set.
3. Press the Function key and confirm the new configuration settings (F-91=2 or 3).
4. Press the Output key. The current can now be controlled with the External resistance.

Function

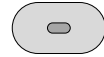

Output



WARNING

Ensure the resistor(s) and cables used exceed the isolation voltage of the power supply. For example: insulation tubes with a withstand voltage higher than the power supply can be used.



Note

When choosing an external resistor ensure the resistor can withstand a high degree of heat.

Please connect the wiring with 2 core shielding line or twisted pair cable briefly. Please do not be affected by foreign noises.

CV and CC Slew Rate Priority are disabled for V-I mode (F-03) when using external resistance control. See the normal function settings on page 57.

During outside voltage control, invalidity becomes the output on/off delay time.

4-1-6. External Control of Output

Background

The output can be turned on or off externally using a switch. The analog control connector can be set to turn the output on from a high or low signal. The voltage across pins 2 and 24 are internally pulled to +5V \pm 5% @ 500uA with 10k Ω pull-up resistor. A short (closed switch) produces a low signal.

By F-94 (output on logic setting by the outside point of contact), it is selectable whether you let the output turn on by short / opening. In addition, please consider setting of F-92 when you constitute the logic in combination with output setting in the power on.

When set to High = On, the output is turned on when the pins 2-24 are open.

When Low = On, the output is turned on when pins 2-24 are shorted

Connection

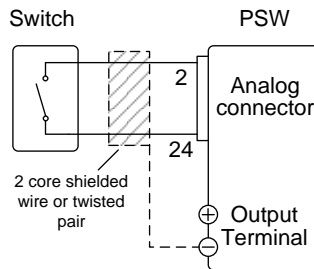

- Pin2 \rightarrow Switch
- Pin24 \rightarrow Switch
- Wire shield \rightarrow negative (-) output terminal

Steps

1. Connect the external switch according to the connection diagrams above.
Set F-94 (External output logic) in the power on configuration settings to 0 (High = On) or 1 (Low = On).
 - Be sure to cycle the power after setting the power on configuration settings.
2. Press the Function key and confirm the new configuration settings.

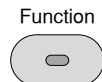

3. The switch is now ready to set the output on or off.
Ensure the cables used and the switch exceed the isolation voltage of the power supply.
For example: insulation tubes with a withstand voltage higher than the power supply can be used.



Note

When using a switch over long distances, please use a switch relay to extend the line from the coil side of the relay.

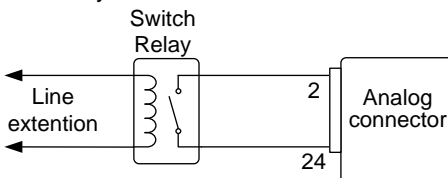

If a single switch control is to be used for multiple units, please isolate each instrument.



Note

Messages: If F-94 = 0 (High = on) and the pin 24 is low (0) "MSG 001" will be displayed on the display.

If F-94 = 1 (Low = on) and the pin 24 is high (1) "MSG 002" will be displayed on the display.

Output off (High=on)

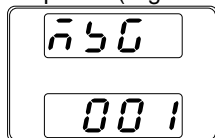

Output off (Low=on)



Note

Output ON/OFF Delay Time (F-01, F-02) are disabled when the output is set to external control. See the normal function settings on 69 for details.

4-1-7. External control of Shutdown

Background

The output of the power supplies can be configured to shut down via an external switch. The ability to externally shut down the power supply must first be enabled in the power on configuration settings. The voltage across pins 2 and 12 are internally pulled to +5V \pm 5% @ 500uA with 10k Ω pull-up resistor.

The handling of shut down method is two kinds. By F-95 (power switch trip setting), it is selectable.

F-95 = 0 \rightarrow A trip is effective

The power switch performs a trip when short-circuit between 12-2 pins.

F-95 = 1 \rightarrow Trip invalidity

The output is off when short-circuit between 12-2 pins. The power switch does not perform a trip.

If you use the shutdown feature, please wait time of 15 seconds or more to power cycle from the power supply off.

Connection

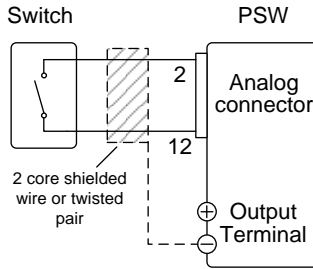

- Pin2 → Switch
- Pin12 → Switch
- Wire shield → negative (-) output terminal

Steps

1. Connect the external switches according to the connection diagrams above.
2. Set F-95 to in the configuration settings to 0 (Enable). This will allow the external control of shutdown.
 - Be sure to cycle the power after setting the power on configuration settings.
3. Press the function key and confirm the new configuration settings.
4. The switch will now shut down the power supply when shorted.

Function

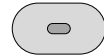

WARNING

Ensure the cables and switch used exceed the isolation voltage of the power supply.
For example: insulation tubes with a withstand voltage higher than the power supply can be used.



Note

When using a switch over long distances, please use a switch relay to extend the line from the coil side of the relay.

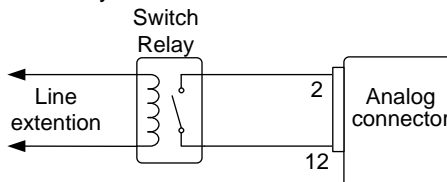

If a single switch control is to be used for multiple units, please isolate each instrument.

4-2. Remote Monitoring

The PSW power supplies have remote monitoring support for current and voltage output. They also support monitoring of operation and alarm status.

4-2-1. External Voltage and Current Monitoring

Background

The MIL 26 pin connector is used to monitor the current (IMON) or voltage (VMON) output.

- An output of 0~10V represents the voltage or current output of 0~ rated current/voltage output.

- $IMON = (\text{current output}/\text{full scale}) \times 10$

- $VMON = (\text{voltage output}/\text{full scale}) \times 10$

External voltage and current monitoring doesn't need to be enabled in the configuration settings

VMON Connection

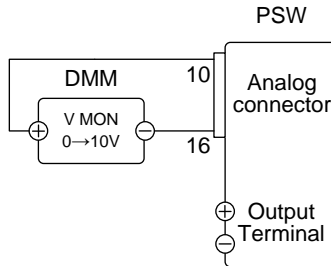

- Pin16 → Neg (-)

- Pin10 → Pos (+)

IMON Connection

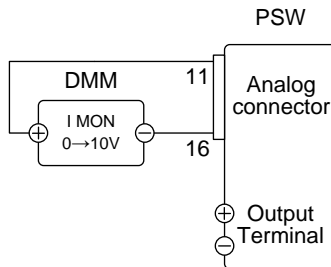

- Pin16 → Neg (-)

- Pin11 → Pos (+) Note



WARNING

As for the monitor signal, there might be the electric shock in the floating output or the series driving for output terminal electric potential.



Note

Ensure IMON(pin 11) and VMON(pin 10) are not shorted together. This will cause damage to the unit.



Note

The output impedance of the voltage (VMON) and current (IMON) monitor pins is 1kΩ. Maximum current is 10mA.

4-2-2. External Operation and Status Monitoring

Background

The MIL 26 pin connector can also be used to monitor the status operation and alarm status of the instrument. The pins are isolated from the power supply internal circuitry by photo couplers. Status Com (Pin 17) is a photo coupler emitter output, whilst pins 18~22 are photo coupler collector outputs. A maximum of 30V and 8mA can be applied to each pin.

Name and Pin	Background
STATUS COM 17	Common (photo coupler emitter) for status signals 18, 19, 20, 21 and 22.
CV STATUS 18	Low when CV mode is active.
CC STATUS 19	Low when CC mode is active.
ALM STATUS 20	Low when any of the protection modes are tripped (OVP, OCP). Active low.
OUT ON STATUS 21	Low when the output is on.
PWR OFF STATUS 22	Active low. Turn on power switch by the internal power supply operation at the time of off or input voltage interception with power switch.

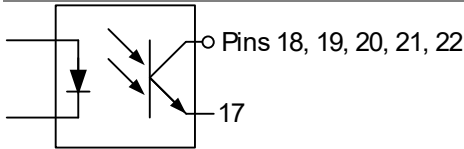

Timing diagrams

Below are 4 example timing diagrams covering a number of scenarios. Note that pins 18~22 are all active low

CV MODE: Output turned on

The diagram below shows the timing diagram when the output is turned on when the PSW is set to CV mode.

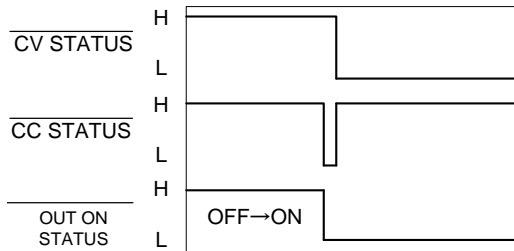

CV MODE: Output turned off

The diagram below shows the output status lines when the output is turned off in CV mode.

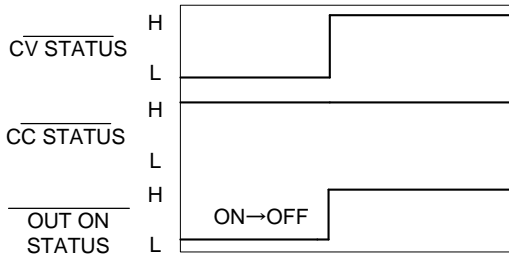

CC MODE: Output turned on

The diagram below shows the timing diagram when the output is turned on when the PSW is set to CC mode.

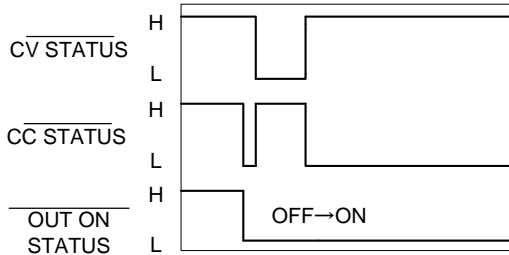

CC MODE: Output turned off

The diagram below shows the output status lines when the output is turned off in CC mode.

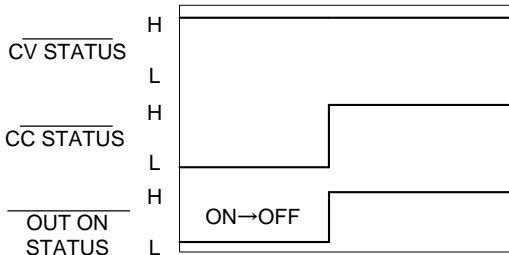

5 Digital Control

This chapter describes basic configuration of IEEE488.2 based remote control. For a command list, refer to the programming manual.

5-1. Interface Configuration

5-1-1. USB Remote Interface

USB configuration	PC side	Type A, host
	connector	
PSW side	connector	Rear panel Type B, slave
	Speed	1.1/2.0 (full speed/high speed)
	USB Class	CDC (communications device class)

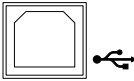
Steps	1. Connect the USB cable to the rear panel USB B port.	
	2. Change the Rear panel-USB (F-22) setting to USB-CDC (2).	

5-1-2. Configure GP-IB Interface

To use GP-IB, the optional GP-IB to USB (GUG-001) adapter must be used.

Only one GP-IB address can be used at a time.

Configure GP-IB	1. Ensure the PSW is off before proceeding.
	2. Connect the USB cable from the rear panel USB B port on the PSW to the USB A port on the GP-IB to USB adapter.
	3. Connect a GP-IB cable from a GP-IB controller to the GP-IB port on the adapter.

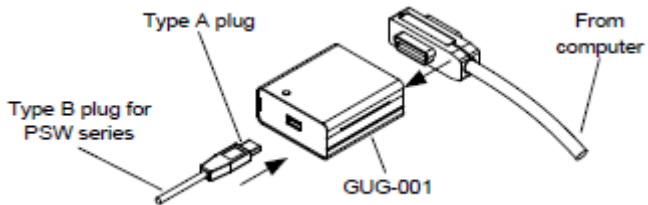

4. Turn the PSW on.
5. Press the Function key to enter the Normal configuration settings.
Set the following GP-IB settings
F-22 = 1 Set the rear panel USB port to GPIB-USB (GUG-001)
F-23 = 0~30 Set the GP-IB address (0~30/ Default : 8)

GP-IB constraints	<ul style="list-style-type: none"> • Maximum 15 devices altogether, 20m cable length, 2m between each device • No loop or parallel connection • Unique address assigned to each device • At least 2/3 of the devices turned On
-------------------	--

5-1-3. Configure RS-232C Interface

To use RS-232C, the optional RS-232C to USB (GUR-001/GUR-001A) adapter must be used.

Configure RS-232C

1. Ensure the PSW is off before proceeding.
2. Connect the USB cable from the rear panel USB B port on the PSW to the USB A port on the RS-232C to USB adapter. Connect the connector and controller with a null modem cable.

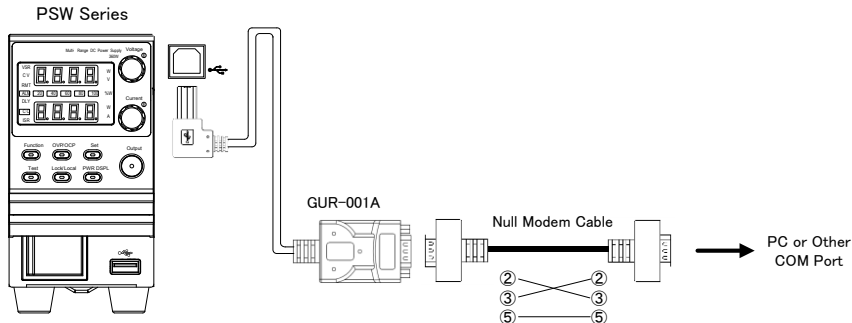

3. Turn the PSW on.
4. Press the Function key to enter the Normal configuration settings.

Set the following RS-232C settings

- | | |
|--------------|--|
| F-22 = 1 | Set the rear panel USB port to RS-232C to USB (GUR-001/GUR-001A) |
| F-71 = 0~7 | Set Baud rate |
| F-72 = 0/1 | Set Data bit |
| F-73 = 0/1/2 | Set parity |
| F-74 = 0/1 | Set Stop bit |

RS-232C constraints

GUR-001 is only available for firmware version V1.76 or above, GUR-001A is only available for firmware version V2.25 or above.
 Delimiter :LF

5-1-4. Configure Ethernet Connection

The Ethernet interface can be configured for a number of different applications. Ethernet can be configured for basic remote control or monitoring using a web server or it can be configured as a socket server.

The PSW series supports both DHCP connections so the instrument can be automatically connected to an existing network or alternatively, network settings can be manually configured.

Ethernet
configuration
Parameters

For details on how to configure the Ethernet settings,
please see the configuration chapter on page 60.

- MAC Address (display only)
- DHCP
- Subnet Mask
- DNS Address
- Web Server Active
- Web set password
0000~9999(default 0000)
- LAN
- IP Address
- Gateway
- Sockets Active
- Web Password Active
- Port number : 2268

5-1-5. Web Server Configuration

Configuration

This configuration example will configure the PSW as a
web server and use DHCP to automatically assign an IP
address to the PSW.

1. Connect an Ethernet cable from the
network to the rear panel Ethernet port.
2. Press the Function key to enter the
Normal configuration settings.

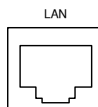

Set the following LAN settings:

- | | |
|----------|------------------------|
| F-36 = 1 | Enable LAN |
| F-37 = 1 | Turn DHCP to enable |
| F-59 = 1 | Turn the web server on |



Note

It may be necessary to cycle the power or refresh the web
browser to connect to a network.

5-1-6. Sockets Server Configuration

Configuration

This configuration example will configure the PSW socket
server.

The following configuration settings will manually assign
the PSW an IP address and enable the socket server. By
default, the socket server port number is 2268 and cannot
be configured.

1. Connect an Ethernet cable from the
network to the rear panel Ethernet port.

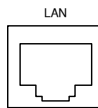

2. Press the Function key to enter the
Normal configuration settings.

Set the following LAN settings:

- | | |
|------------|-------------------------|
| F-36 = 1 | Enable LAN |
| F-37 = 0 | Disable DHCP |
| F-39 = 172 | IP Address part 1 of 4 |
| F-40 = 16 | IP Address part 2 of 4 |
| F-41 = 5 | IP Address part 3 of 4 |
| F-42 = 133 | IP Address part 4 of 4 |
| F-43 = 255 | Subnet Mask part 1 of 4 |
| F-44 = 255 | Subnet Mask part 2 of 4 |

F-45 = 128	Subnet Mask part 3 of 4
F-46 = 0	Subnet Mask part 4 of 4
F-47 = 172	Gateway part 1 of 4
F-48 = 16	Gateway part 2 of 4
F-49 = 21	Gateway part 3 of 4
F-50 = 101	Gateway part 4 of 4
F-57 = 1	Enable Sockets



Note

The socket function is only available for firmware version V1.12 or above.

5-2. Interface check

5-2-1. USB Remote Control Function Check

Functionality
check

If PSW is not recognized by the COM port, install a driver (inf file) from Manual CD. The USB device driver of psw is more downloadable than our Web site.

When USB connects psw to a computer for the first time, installation of the USB device driver is required. Please perform the installation from the Device Manager if a computer can't recognize psw.

Control Panel – All Control Panel Items – Device Manager – Other Device – PSW (Right click)
– Update driver Software

Please prepare for terminal application (Realterm or PuTTY). The format of (serial communication) of the COM port as follows.

- Baud rate:9600bps
- Parity bit :None
- Flow control:None
- The data head: 8bit
- Stop bit : 1bit

Run this query command via the terminal after the instrument has been configured for USB remote control
*idn?

This should return the Manufacturer, Model number, Serial number, and Firmware version in the following format.

TEXIO,PSW-360L30,TW123456,01.00.20110101

Manufacturer : TEXIO

Model number : PSW-360L30

Serial number : TW123456

Firmware version : 01.00.20110101

^j can be used as the terminal character when entering the queries/commands from a terminal application.



Note

For further details, please see the programming manual.

5-2-2. Web Server Remote Control Function Check

Functionality
check

Enter the IP address of the power supply in a web browser after the instrument has been configured as a web server.
http:// XXX.XXX.XXX.XXX

The web browser interface appears.



Note

For further details, please see the programming manual.

5-2-3. Socket Server Function Check

Background To test the socket server functionality, National Instruments Measurement and Automation Explorer can be used. This program is available on the NI website, www.ni.com, via a search for the VISA Run-time Engine page, or “downloads” at the following URL, <http://www.ni.com/visa/>

Requirements PSW Firmware: V1.12
PC Operating System(OS): Windows 7 or higher

Functionality check

1. Start the NI Measurement and Automation Explorer (MAX) program.
start>All PROGRAM>National Instruments>Measurement & Automation

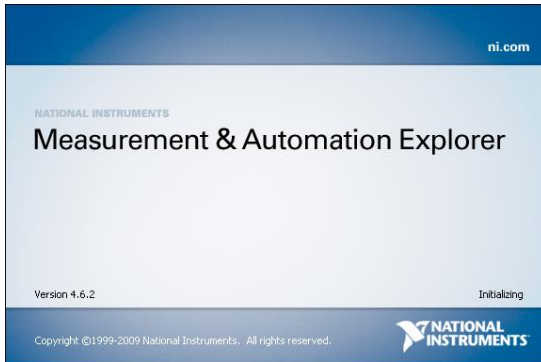

2. From the Configuration panel access My System>Devices and Interfaces>Network Devices
3. Press Add New Network Device>Visa TCP/IP Resource

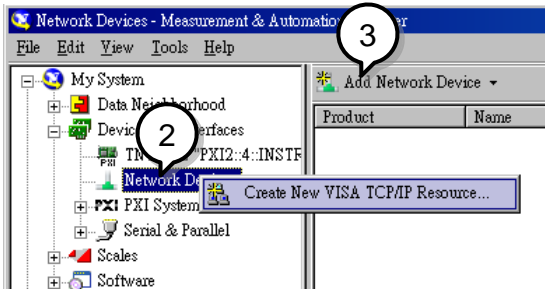

4. Select Manual Entry of Raw Socket from the popup window.

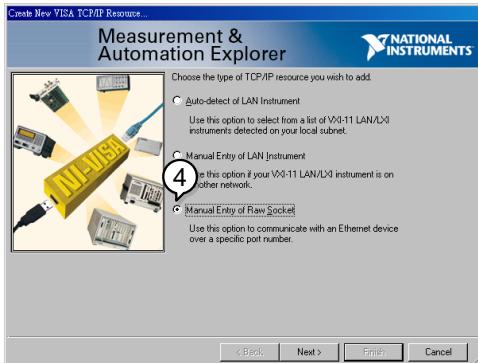

5. Enter the IP address and the port number of the PSW. The port number is fixed at 2268.
6. Double click the Validate button.

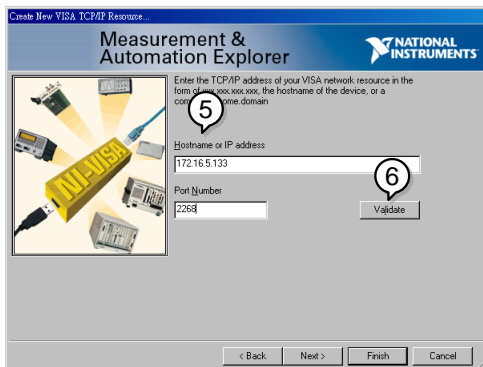

7. Next configure the Alias (name) of the PSW connection. Example : PSW_DC1
8. Click finish.

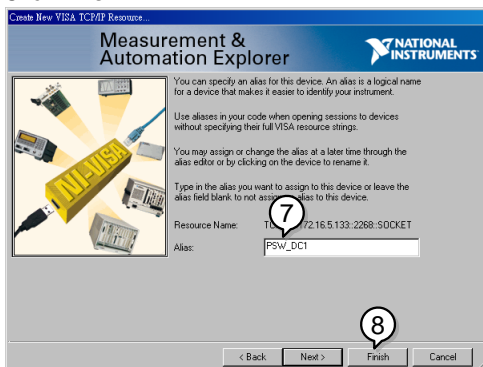

9. The IP address of the PSW will now appear under Network Devices in the configuration panel. Select this icon now.
10. Press Open VISA Test Panel.

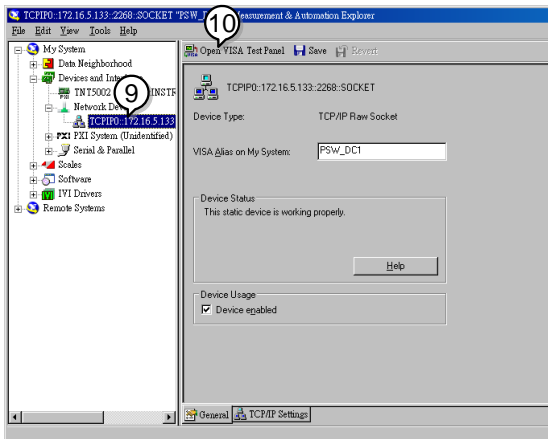

11. Under the Template > Property Node tabs, set Termination Char Enable from the Attribute Name list to VI_TRUE.

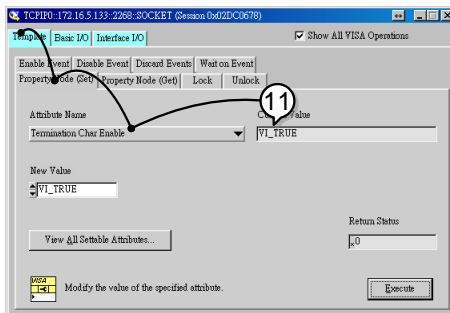

12. Under the Basic I/O > Write tabs, Enter the *IDN? query into the Buffer, if it is not already there.

13. Click the Execute button.

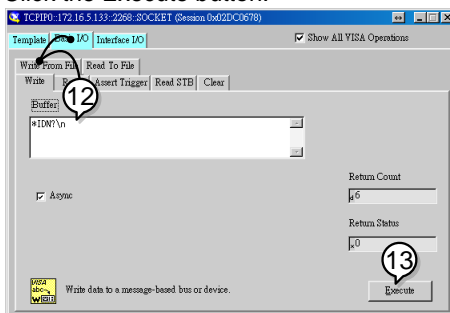

14. In the Basic I/O > Read tabs, the return parameter for the *IDN? query should be returned to the buffer area TEXTIO,PSW-xxxx,,T1.12.20111013

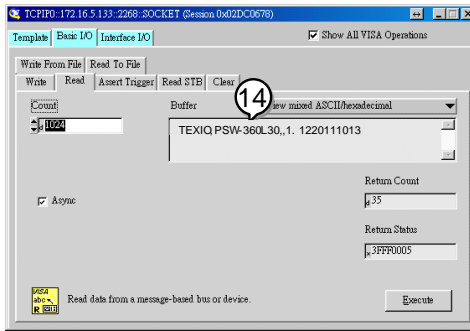

For further details, please see the programming manual.

Display and operated by a version of NI-MAX is different. Please operate in accordance with the version you are using.

6 MAINTENANCE

The PSW power supply filters should be replaced on a periodic schedule to maintain performance and specification characteristics.

6-1. Replacing the Dust Filter

The dust filter should be replaced at least 2 times a year. Not replacing the filter on a regular basis will reduce performance and may cause the unit to overheat

- Front panel filter (all models)
1. Turn the instrument off.
 2. Pull the filter out from the bottom of the front panel.

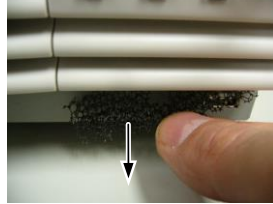

3. Replace the filter with part number PSW-010.

- Side panel filters (Type II & Type III)
1. Lift the side panel up and away from the case.

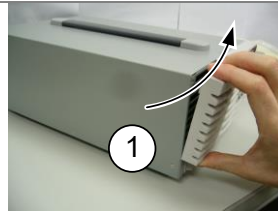

2. Remove the filter from the grill and replace with a new filter (part number PSW-010).

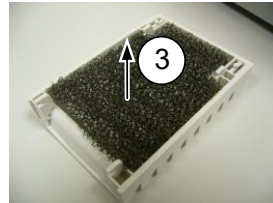

7 FAQ

- The power supply won't let me change the mode (CVmode↔CCmode).
To set the power supply to CC or CV mode, the Function key must be held when the power is turned on to enter the Power On Configuration Mode.
- The OVP voltage is triggered earlier than expected.
When setting the OVP voltage, take into account the voltage drop from the load cables. As the OVP level is set from the output terminals and not the load terminals, the voltage at the load terminals may be slightly lower.
- Can I combine more than 1 cable together for the output wiring?
Yes. Cables can be used together (in parallel) if the current capacity of a single cable is insufficient. However the withstand voltage should also be taken into account. Ensure the cables are twisted together and are the same length
- The accuracy does not match the specification.
Make sure the device is powered On for at least 30 minutes, within +18°C~+28°C. This is necessary to stabilize the unit to match the specification.

For more information, contact your local dealer or us.

8 APPENDIX

8-1. PSW Default Settings

The following default settings are the factory configuration settings for the power supply (Function settings/Test settings).

For details on how to return to the factory default settings, see page 26.

Initial Settings	Default Setting	
Output	Off	
Key Lock	0 (Disabled)	
Voltage	0 V	
Current	0 A	
OVP	Maximum	
OCP	Maximum	
Normal Function Settings	Setting	Default Setting
Output ON delay time	F-01	0.00s
Output OFF delay time	F-02	0.00s
V-I mode slew rate select	F-03	0 = CV high speed priority
	F-04	60.00V/s (PSW-XXL30) 160.0V/s (PSW-XXL80)
Rising voltage slew rate		320.0V/s (PSW-XXM160) 500.0V/s (PSW-XXM250) 1600V/s (PSW-XXH800)
	F-05	60.00V/s (PSW-XXL30) 160.0V/s (PSW-XXL80)
Falling voltage slew rate		320.0V/s (PSW-XXM160) 500.0V/s (PSW-XXM250) 1600V/s (PSW-XXH800) 72.00A/s (PSW-360L30) 144.0A/s (PSW-720L30) 216.0A/s (PSW-1080L30) 27.00A/s (PSW-360L80) 54.00A/s (PSW-720L80) 81.00A/s (PSW-1080L80) 14.40A/s (PSW-360M160)
	F-06	28.80A/s (PSW-720M160) 43.20A/s (PSW-1080M160) 9.000A/s (PSW-360M250) 18.00A/s (PSW-720M250) 27.00A/s (PSW-1080M250) 2.880A/s (PSW-360H800) 5.760A/s (PSW-720H800) 8.640A/s (PSW-1080H800)

		72.00A/s (PSW-360L30)
		144.0A/s (PSW-720L30)
		216.0A/s (PSW-1080L30)
		27.00A/s (PSW-360L80)
		54.00A/s (PSW-720L80)
		81.00A/s (PSW-1080L80)
		14.40A/s (PSW-360M160)
Falling current slew rate	F-07	28.80A/s (PSW-720M160)
		43.20A/s (PSW-1080M160)
		9.000A/s (PSW-360M250)
		18.00A/s (PSW-720M250)
		27.00A/s (PSW-1080M250)
		2.880A/s (PSW-360H800)
		5.760A/s (PSW-720H800)
		8.640A/s (PSW-1080H800)
Internal resistance setting	F-08	0.000Ω
Bleeder circuit control	F-09	1 = ON
Buzzer ON/OFF control	F-10	1 = ON
Measurement Average Setting	F-17	0 = Low
Lock Mode	F-19	0 = Panel lock: allow output off
USB/GP-IB setting		
Rear Panel USB Mode	F-22	2 = USB CDC
GP-IB Address	F-23	8
LAN setting		
LAN	F-36	1 = Enable
DHCP	F-37	1 = Enable
Sockets active	F-57	1 = Enable
Web Server active	F-59	1 = Enable
Web password active	F-60	1 = Enable
Web setting password	F-61	0000
RS-232C		
Baud rate	F-71	7(115200bps)
Data bit	F-72	1(8bit)
Parity	F-73	0(none)
Stop bit	F-74	0(1bit)
Power On Configuration		
CV Control	F-90	0= Panel control (local)
CC Control	F-91	0= Panel control (local)
Power-ON Output	F-92	0 = OFF at startup
Master/Slave	F-93	0 = Master/Local
External Out Logic	F-94	0 = High ON
Power Switch trip	F-95	0 = Enable
Data of the test script is not cleared by the initialization by F-88.		

8-2. Error Messages & Messages

The following error messages or messages may appear on the PSW screen during operation.

Error Messages	Description
Err 001	USB Mass Storage is not present
Err 002	No (such)file in USB mass storage
Err 003	Empty memory location
Err 004	File access error

For error messages other than Err 001 to Err 004, please contact your distributor for service repair.

Messages	Description
MSG 001	External control of output. Output off (F-94=0, High=on)
MSG 002	External control of output. Output off (F-94=1, Low=on)
MSG 003	F-93 is not zero. Unable to calibrate.
LOCK F-19	F-19 is zero. Unable to turn the output on.

8-3. LCD Display Format

Use the following table to read the LCD display messages.

0	1	2	3	4	5	6	7	8	9	A	B	C	D
<i>0</i>	<i>1</i>	<i>2</i>	<i>3</i>	<i>4</i>	<i>5</i>	<i>6</i>	<i>7</i>	<i>8</i>	<i>9</i>	<i>A</i>	<i>b</i>	<i>C</i>	<i>d</i>
E	F	G	H	I	J	K	L	M	N	O	P	Q	R
<i>E</i>	<i>F</i>	<i>G</i>	<i>H</i>	<i>I</i>	<i>J</i>	<i>K</i>	<i>L</i>	<i>M</i>	<i>N</i>	<i>O</i>	<i>P</i>	<i>Q</i>	<i>R</i>
S	T	U	V	W	X	Y	Z	()	+	-	,	
<i>S</i>	<i>T</i>	<i>U</i>	<i>V</i>	<i>W</i>	<i>X</i>	<i>Y</i>	<i>Z</i>	<i>(</i>	<i>)</i>	<i>+</i>	<i>-</i>	<i>,</i>	

9 Specifications

The specifications apply when the PSW is powered on for at least 30 minutes , within +18°C~+28°C.

9-1. PSW 360W Type I

Model	Unit	PSW-360 L30	PSW-360 L80	PSW-360 M160	PSW-360 M250	PSW-360 H800
Rated Output Voltage	V	30	80	160	250	800
Rated Output Current	A	36	13.5	7.2	4.5	1.44
Rated Output Power	W	360	360	360	360	360
Power Ratio	--	3	3	3.2	3.125	3.2
Constant Voltage Mode						
Line Regulation (*1)	mV	18	43	83	128	403
Load Regulation (*2)	mV	20	45	85	130	405
Ripple and Noise (*3)						
p-p (*4)	mV	60	60	60	80	150
r.m.s (*5)	mV	7	7	12	15	30
Temperature coefficient	ppm/°C	100ppm/ °C after a 30 minute warm-up				
Remote sense compensation voltage (single wire)	V	0.6	0.6	0.6	1	1
Rise Time (*6)						
Rated Load	ms	50	50	100	100	150
No Load	ms	50	50	100	100	150
Fall Time (*7)						
Rated Load	ms	50	50	100	150	300
No Load	ms	500	500	1000	1200	2000
Transient response time (*8)	ms	1	1	2	2	2
Constant Current Mode						
Line regulation (*1)	mA	41	18.5	12.2	9.5	6.44
Load regulation (*9)	mA	41	18.5	12.2	9.5	6.44
Ripple and noise						
r.m.s	mA	72	27	15	10	5
Temperature coefficient	ppm/°C	200ppm/ °C after a 30 minute warm-up				
Protection Function						
Over voltage protection (OVP)						
Setting range	V	3-33	8-88	16-176	20-275	20-880
Setting accuracy		± (2% of rated output voltage)				
Over current protection (OCP)						
Setting range	A	3.6-39.6	1.35-14.85	0.72-7.92	0.45-4.95	0.144-1.584
Setting accuracy		± (2% of rated output current)				
Over temperature protection (OTP/OHP)						
Operation		Turn the output off.				
Low AC input protection (AC-FAIL)						

Operation	Turn the output off.					
Power limit (POWER LIMIT)						
Operation	Over power limit.					
Value (fixed)	Approx. 105% of rated output power					
Analog Programming and Monitoring						
External voltage control output voltage	Accuracy and linearity: $\pm 0.5\%$ of rated output voltage.					
External voltage control output current	Accuracy and linearity: $\pm 1\%$ of rated output current.					
External resistor control output voltage	Accuracy and linearity: $\pm 1.5\%$ of rated output voltage.					
External resistor control output current	Accuracy and linearity: $\pm 1.5\%$ of rated output current.					
Output voltage monitor						
Accuracy	%	± 1	± 1	± 1	± 2	± 2
Output current monitor						
Accuracy	%	± 1	± 1	± 1	± 2	± 2
Shutdown control	Turns the output or power off with a LOW (0V ~ 0.5V) or short-circuit.					
Output on/off control	Possible logic selections: Turn the output on using a LOW (0V ~ 0.5V) or short-circuit, turn the output off using a HIGH (4.5V ~ 5V) or open-circuit. Turn the output on using a HIGH (4.5V ~ 5V) or open-circuit, turn the output off using a LOW (0V ~ 0.5V) or short-circuit.					
CV/CC/ALM/PWR ON/OUT ON indicator	Photocoupler open collector output; Maximum voltage 30V, maximum sink current 8mA.					
Front Panel						
Display	4 digits					
Voltage accuracy 0.1% +	mV	20	20	100	200	400
Current accuracy 0.1% +	mA	40	20	5	5	2
Indications	GREEN LED's: CV, CC, VSR, ISR, DLY, RMT, 20, 40, 60, 80, 100, %W, W, V, A RED LED's: ALM					
Buttons	Function, OVP/OCP, Set, Test, Lock/Local, PWR DSPL, Output					
Knobs	Voltage, Current					
USB port	Type A USB connector					
Programming and Measurement (USB, LAN, GPIB)						
Output voltage programming accuracy 0.1% +	mV	10	10	100	200	400
Output current programming accuracy 0.1% +	mA	30	10	5	5	2

Output voltage programming resolution	mV	1	2	3	5	14
Output current programming resolution	mA	1	1	1	1	1
Output voltage measurement accuracy 0.1% +	mV	10	10	100	200	400
Output current measurement accuracy 0.1% +	mA	30	10	5	5	2
Output voltage measurement resolution	mV	1	2	3	5	14
Output current measurement resolution	mA	1	1	1	1	1
Series and Parallel Capability						
Parallel number	Units	3	3	3	3	3
Series Number	Units	2	2	2	None	None
Input Characteristics						
Nominal input rating	100Vac ~ 240Vac, 50Hz to 60Hz, single phase					
Input voltage range	85Vac ~ 265Vac					
Input voltage range	47Hz ~ 63Hz					
Maximum input current						
100Vac	A	5				
200Vac	A	2.5				
Inrush current	Less than 25A.					
Maximum input power	VA	500				
Power factor						
100Vac	0.99					
200Vac	0.97					
Efficiency						
100Vac	%	77	78	79	79	80
200Vac	%	79	80	81	81	82
Hold-up time	20ms or greater					
Environmental Conditions						
Operating temperature	0°C ~ 50°C					
Storage temperature	-25°C ~ 70°C					
Operating humidity	20% ~ 85% RH; No condensation					
Storage humidity	90% RH or less; No condensation					
Altitude	Maximum 2000m					
General Specifications						
Weight (main unit only)	kg	Approx. 3kg				
Dimensions (WxHxD)	mm	71x124x350				

*1: At 85 ~ 132Vac or 170 ~ 265Vac, constant load.

*2: From No-load to Full-load, constant input voltage. Measured at the sensing point in Remote Sense.

*3: Measure with JEITA RC-9131B (1:1) probe

*4: Measurement frequency bandwidth is 10Hz to 20MHz.

*5: Measurement frequency bandwidth is 5Hz to 1MHz.

*6: From 10% to 90% of rated output voltage, with rated resistive load.

*7: From 90% to 10% of rated output voltage, with rated resistive load.

*8: Time for output voltage to recover within 0.1% + 10mV of its rated output for a load change from 50 to 100% of its rated output current.

*9: For load voltage change, equal to the unit voltage rating, constant input voltage.

9-2. PSW 720W Type II

Model	Unit	PSW-720 L30	PSW-720 L80	PSW-720 M160	PSW-720 M250	PSW-720 H800
Rated Output Voltage	V	30	80	160	250	800
Rated Output Current	A	72	27	14.4	9	2.88
Rated Output Power	W	720	720	720	720	720
Power Ratio	--	3	3	3.2	3.125	3.2
Constant Voltage Mode						
Line Regulation (*1)	mV	18	43	83	128	403
Load Regulation (*2)	mV	20	45	85	130	405
Ripple and Noise (*3)						
p-p (*4)	mV	80	80	80	100	200
r.m.s (*5)	mV	11	11	15	15	30
Temperature coefficient	ppm/°C	100ppm/°C after a 30 minute warm-up				
Remote sense compensation voltage (single wire)						
Remote sense compensation voltage	V	0.6	0.6	0.6	1	1
Rise Time (*6)						
Rated Load	ms	50	50	100	100	150
No Load	ms	50	50	100	100	150
Fall Time (*7)						
Rated Load	ms	50	50	100	150	300
No Load	ms	500	500	1000	1200	2000
Transient response time (*8)						
Transient response time	ms	1	1	2	2	2
Constant Current Mode						
Line regulation (*1)	mA	77	32	19.4	14	7.88
Load regulation (*9)	mA	77	32	19.4	14	7.88
Ripple and noise						
r.m.s(*5)	mA	144	54	30	20	10
Temperature coefficient	ppm/°C	200ppm/°C after a 30 minute warm-up				
Protection Function						
Over voltage protection (OVP)						
Setting range	V	3-33	8-88	16-176	20-275	20-880
Setting accuracy		± (2% of rated output voltage)				
Over current protection (OCP)						
Setting range	A	5-79.2	2.7-29.7	1.44-15.84	0.9-9.9	0.288-3.168

Setting accuracy	± (2% of rated output current)					
Over temperature protection (OTP/OHP)						
Operation	Turn the output off.					
Low AC input protection (AC-FAIL)						
Operation	Turn the output off.					
Power limit (POWER LIMIT)						
Operation	Over power limit.					
Value (fixed)	Approx. 105% of rated output power					
Analog Programming and Monitoring						
External voltage control output voltage	Accuracy and linearity: ±0.5% of rated output voltage.					
External voltage control output current	Accuracy and linearity: ±1% of rated output current.					
External resistor control output voltage	Accuracy and linearity: ±1.5% of rated output voltage.					
External resistor control output current	Accuracy and linearity: ±1.5% of rated output current.					
Output voltage monitor						
Accuracy	%	±1	±1	±1	±2	±2
Output current monitor						
Accuracy	%	±1	±1	±1	±2	±2
Shutdown control						
Turns the output or power off with a LOW (0V ~ 0.5V) or short-circuit.						
Output on/off control						
Possible logic selections: Turn the output on using a LOW (0V ~ 0.5V) or short-circuit, turn the output off using a HIGH (4.5V ~ 5V) or open-circuit. Turn the output on using a HIGH (4.5V ~ 5V) or open-circuit, turn the output off using a LOW (0V ~ 0.5V) or short-circuit.						
CV/CC/ALM/PWR ON/OUT ON indicator						
Photocoupler open collector output; Maximum voltage 30V, maximum sink current 8mA.						
Front Panel						
Display, 4 digits						
Voltage accuracy						
0.1% +	mV	20	20	100	200	400
Current accuracy						
0.1% +	mA	70	40	30	10	4
Indications						
GREEN LED's: CV, CC, VSR, ISR, DLY, RMT, 20, 40, 60, 80, 100, %W, W, V, A						
RED LED's: ALM						
Buttons						
Function, OVP/OCP, Set, Test, Lock/Local, PWR DSPL, Output						
Knobs						
Voltage, Current						
USB port						
Type A USB connector						
Programming and Measurement (USB, LAN, GPIB)						
Output voltage program						
-ming accuracy 0.1% +	mV	10	10	100	200	400

Output current program							
-ming accuracy 0.1% +	mA	60	30	15	10	4	
Output voltage program							
-ming resolution	mV	1	2	3	5	14	
Output current program							
-ming resolution	mA	2	2	2	1	1	
Output voltage measure							
-ment accuracy 0.1% +	mV	10	10	100	200	400	
Output current measure							
-ment accuracy 0.1% +	mA	60	30	15	10	4	
Output voltage measure							
-ment resolution	mV	1	2	3	5	14	
Output current measure							
-ment resolution	mA	2	2	2	1	1	
Series and Parallel Capability							
Parallel number	Units	3	3	3	3	3	
Series Number	Units	2	2	2	None	None	
Input Characteristics							
Nominal input rating	100Vac ~ 240Vac, 50Hz ~ 60Hz, single phase						
Input voltage range	85Vac ~ 265Vac						
Input voltage range	47Hz ~ 63Hz						
Maximum input current							
100Vac	A	10					
200Vac	A	5					
Inrush current	Less than 50A.						
Maximum input power	VA	1000					
Power factor							
100Vac	0.99						
200Vac	0.97						
Efficiency							
100Vac	%	77	78	79	79	80	
200Vac	%	79	80	81	81	82	
Hold-up time	20ms or greater						
General Specifications							
Weight (main unit only)	Approx. 5.3kg						
Dimensions (WxHxD)	mm	142x124x350					

*1: At 85 ~ 132Vac or 170 ~ 265Vac, constant load.

*2: From No-load to Full-load, constant input voltage. Measured at the sensing point in Remote Sense.

*3: Measure with JEITA RC-9131B (1:1) probe

*4: Measurement frequency bandwidth is 10Hz to 20MHz.

*5: Measurement frequency bandwidth is 5Hz to 1MHz.

*6: From 10% to 90% of rated output voltage, with rated resistive load.

*7: From 90% to 10% of rated output voltage, with rated resistive load.

*8: Time for output voltage to recover within 0.1% + 10mV of its rated output for a load change from 50 to 100% of its rated output current.

*9: For load voltage change, equal to the unit voltage rating, constant input voltage.

9-3. PSW 1080W Type III

Model	Unit	PSW-1080 L30	PSW-1080 L80	PSW-1080 M160	PSW-1080 M250	PSW-1080 H800
Rated Output Voltage	V	30	80	160	250	800
Rated Output Current	A	108	40.5	21.6	13.5	4.32
Rated Output Power	W	1080	1080	1080	1080	1080
Power Ratio	--	3	3	3.2	3.125	3.2
Constant Voltage Mode						
Line Regulation (*1)	mV	18	43	83	128	403
Load Regulation (*2)	mV	20	45	85	130	405
Ripple and Noise (*3)						
p-p (*4)	mV	100	100	100	120	200
r.m.s (*5)	mV	14	14	20	15	30
Temperature coefficient	ppm/°C	100ppm/ °C after a 30 minute warm-up				
Remote sense compensation voltage (single wire)						
V	V	0.6	0.6	0.6	1	1
Rise Time (*6)						
Rated Load	ms	50	50	100	100	150
No Load	ms	50	50	100	100	150
Fall Time (*7)						
Rated Load	ms	50	50	100	150	300
No Load	ms	500	500	1000	1200	2000
Transient response time (*8)						
ms	ms	1	1	2	2	2
Constant Current Mode						
Line regulation (*1)	mA	113	45.5	26.6	18.5	9.32
Load regulation (*9)	mA	113	45.5	26.6	18.5	9.32
Ripple and noise						
r.m.s(*5)	mA	216	81	45	30	15
Temperature coefficient	ppm/°C	200ppm/ °C after a 30 minute warm-up				
Protection Function						
Over voltage protection (OVP)						
Setting range	V	3-33	8-88	16-176	20-275	20-880
Setting accuracy		± (2% of rated output voltage)				
Over current protection (OCP)						
Setting range	A	5-118.8	4.05-44.55	2.16-23.76	1.35-14.85	0.432-4.752
Setting accuracy		± (2% of rated output current)				
Over temperature protection (OTP/OHP)						
Operation		Turn the output off.				
Low AC input protection (AC-FAIL)						
Operation		Turn the output off.				

Power limit (POWER LIMIT)							
Operation	Over power limit.						
Value (fixed)	Approx. 105% of rated output power						
Analog Programming and Monitoring							
External voltage control output voltage	Accuracy and linearity: $\pm 0.5\%$ of rated output voltage.						
External voltage control output current	Accuracy and linearity: $\pm 1\%$ of rated output current.						
External resistor control output voltage	Accuracy and linearity: $\pm 1.5\%$ of rated output voltage.						
External resistor control output current	Accuracy and linearity: $\pm 1.5\%$ of rated output current.						
Output voltage monitor							
Accuracy	%	± 1	± 1	± 1	± 2	± 2	
Output current monitor							
Accuracy	%	± 1	± 1	± 1	± 2	± 2	
Shutdown control	Turns the output or power off with a LOW (0V ~ 0.5V) or short-circuit.						
Output on/off control	Possible logic selections: Turn the output on using a LOW (0V ~ 0.5V) or short-circuit, turn the output off using a HIGH (4.5V ~ 5V) or open-circuit. Turn the output on using a HIGH (4.5V ~ 5V) or open-circuit, turn the output off using a LOW (0V ~ 0.5V) or short-circuit.						
CV/CC/ALM/PWR ON/OUT ON indicator	Photocoupler open collector output; Maximum voltage 30V, maximum sink current 8mA.						
Front Panel							
Display, 4 digits							
Voltage accuracy 0.1% +	mV	20	20	100	200	400	
Current accuracy 0.1% +	mA	100	50	30	20	6	
Indications	GREEN LED's: CV, CC, VSR, ISR, DLY, RMT, 20, 40, 60, 80, 100, %W, W, V, A RED LED's: ALM						
Buttons	Function, OVP/OCP, Set, Test, Lock/Local, PWR DSPL, Output						
Knobs	Voltage, Current						
USB port	Type A USB connector						
Programming and Measurement (USB, LAN, GPIB)							
Output voltage program -ing accuracy 0.1% +	mV	10	10	100	200	400	
Output current program -ing accuracy 0.1% +	mA	100	40	20	15	6	
Output voltage program -ming resolution	mV	1	2	3	5	14	
Output current program -ming resolution	mA	3	3	3	1	1	

Output voltage measurement accuracy 0.1% +	mV	10	10	100	200	400
Output current measurement accuracy 0.1% +	mA	100	40	20	15	6
Output voltage measurement resolution	mV	1	2	3	5	14
Output current measurement resolution	mA	3	3	3	1	1
Series and Parallel Capability						
Parallel number	Units	3	3	3	3	3
Series Number	Units	2	2	2	None	None
Input Characteristics						
Nominal input rating	100Vac ~ 240Vac, 50Hz ~ 60Hz, single phase					
Input voltage range	85Vac ~ 265Vac					
Input voltage range	47Hz ~ 63Hz					
Maximum input current						
100Vac	A	15				
200Vac	A	7.5				
Inrush current	Less than 75A.					
Maximum input power	VA	1500				
Power factor						
100Vac	0.99					
200Vac	0.97					
Efficiency						
100Vac	%	77	78	79	79	80
200Vac	%	79	80	81	81	82
Hold-up time	20ms or greater					
Environmental Conditions						
Operating temperature	0°C ~ 50°C					
Storage temperature	-25°C ~ 70°C					
Operating humidity	20% ~ 85% RH; No condensation					
Storage humidity	90% RH or less; No condensation					
Altitude	Maximum 2000m					
General Specifications						
Weight (main unit only)	Approx. 7.5kg					
Dimensions (WxHxD)	mm	214x124x350				

*1: At 85 ~ 132Vac or 170 ~ 265Vac, constant load.

*2: From No-load to Full-load, constant input voltage. Measured at the sensing point in Remote Sense.

*3: Measure with JEITA RC-9131B (1:1) probe

*4: Measurement frequency bandwidth is 10Hz to 20MHz.

*5: Measurement frequency bandwidth is 5Hz to 1MHz.

*6: From 10% to 90% of rated output voltage, with rated resistive load.

*7: From 90% to 10% of rated output voltage, with rated resistive load.

*8: Time for output voltage to recover within 0.1% + 10mV of its rated output for a load change from 50 to 100% of its rated output current.

*9: For load voltage change, equal to the unit voltage rating, constant input voltage.

9-4. Common

Interface Capabilities	
USB	TypeA: Host, TypeB: Slave, Speed: 1.1/2.0, USB Class: CDC(Communications Device Class)
LAN	MAC Address, DNS IP Address, User Password, Gateway IP Address, Instrument IP Address, Subnet Mask
GPIB	Optional: GUG-001 (GPIB USB Adapter)
RS-232C	Optional:GUR-001(RS-232C Adapter) Optional:GUR-001A(RS-232C Adapter)
General Specifications	
Cooling	Forced air cooling by internal fan.
EMC	EN61326-1:2013(2014/30/EU)
Safety	EN61010-1:2010(2014/35/EU)
Withstand voltage	Between input and chassis: No abnormalities at 1500 Vac for 1 minute. Between input and output: No abnormalities at 3000 Vac for 1 minute. Between output and chassis: No abnormalities at 500 Vdc for 1 minute for 30V, 80V, 160V models. No abnormalities at 1500 Vdc for 1 minute for 250V, 800V models.
Insulation resistance	Between input and chassis: 500 Vdc, 100MΩ or more Between input and output: 500 Vdc, 100MΩ or more Between output and chassis: 500 Vdc, 100MΩ or more for 30V, 80V, 160V and 250V models. 1000Vdc, 100MΩ or more for 800V models.

9-5. PSW Dimensions

Type I:360W

PSW-360M160/PSW-360L80/PSW-360L30 (mm)

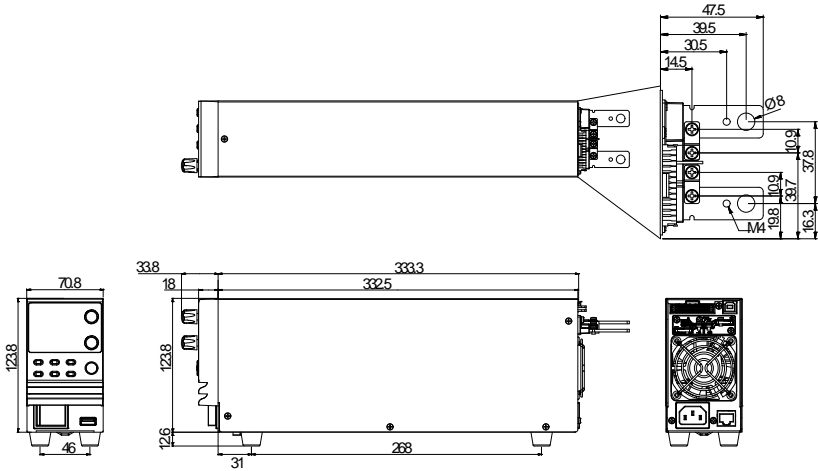

PSW-360M250/PSW-360H800(mm)

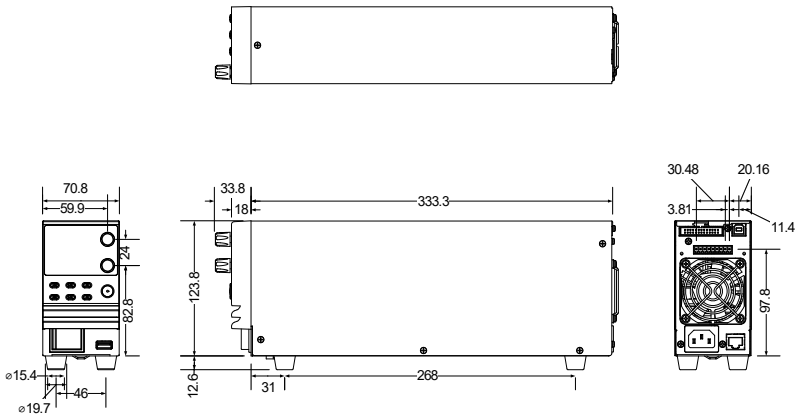

Type II:720W

PSW-720M160/PSW-720L80/PSW-720L30 (mm)

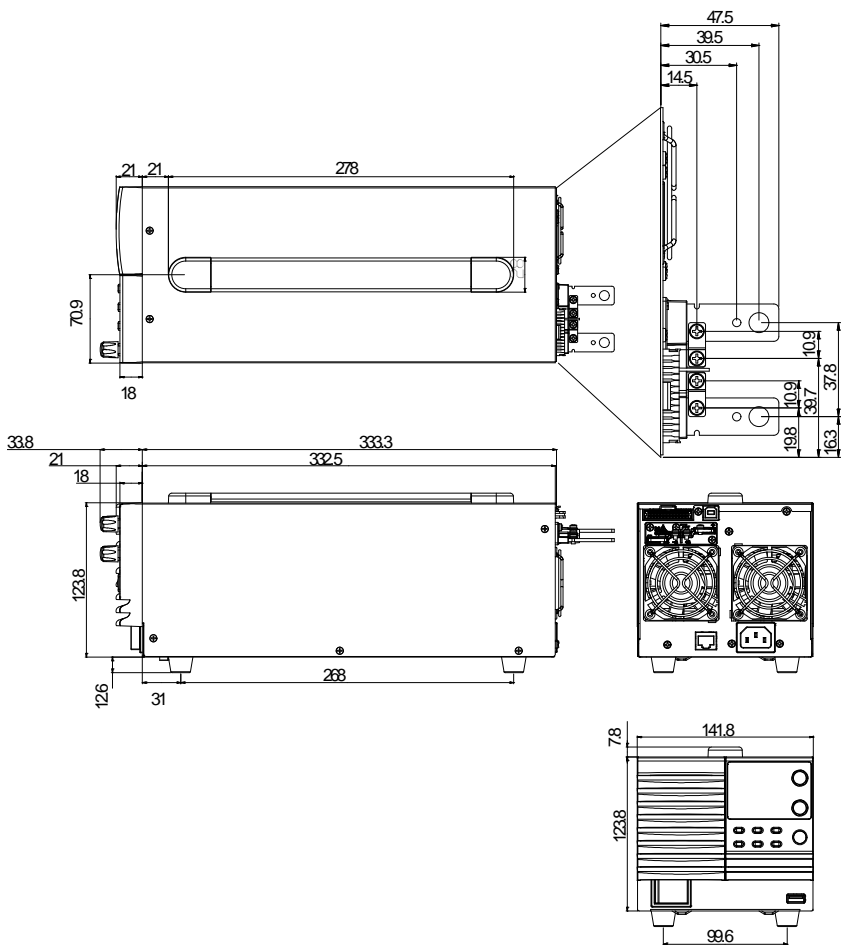

PSW-720M250/PSW-720H800 (mm)

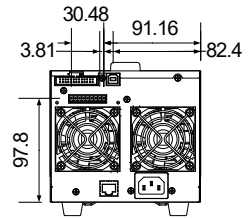
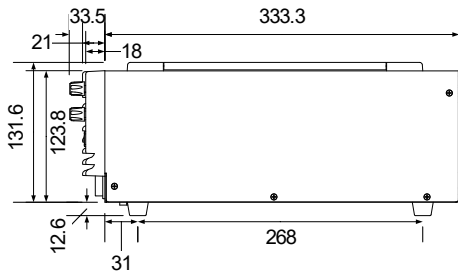
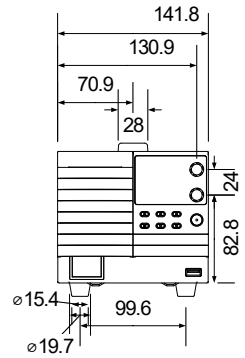
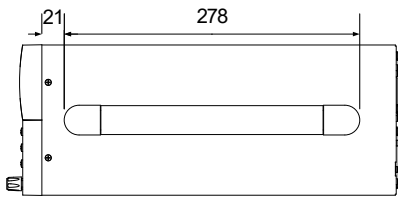

Type III:1080W

PSW-1080M160/PSW-1080L80/PSW-1080L30 (mm)

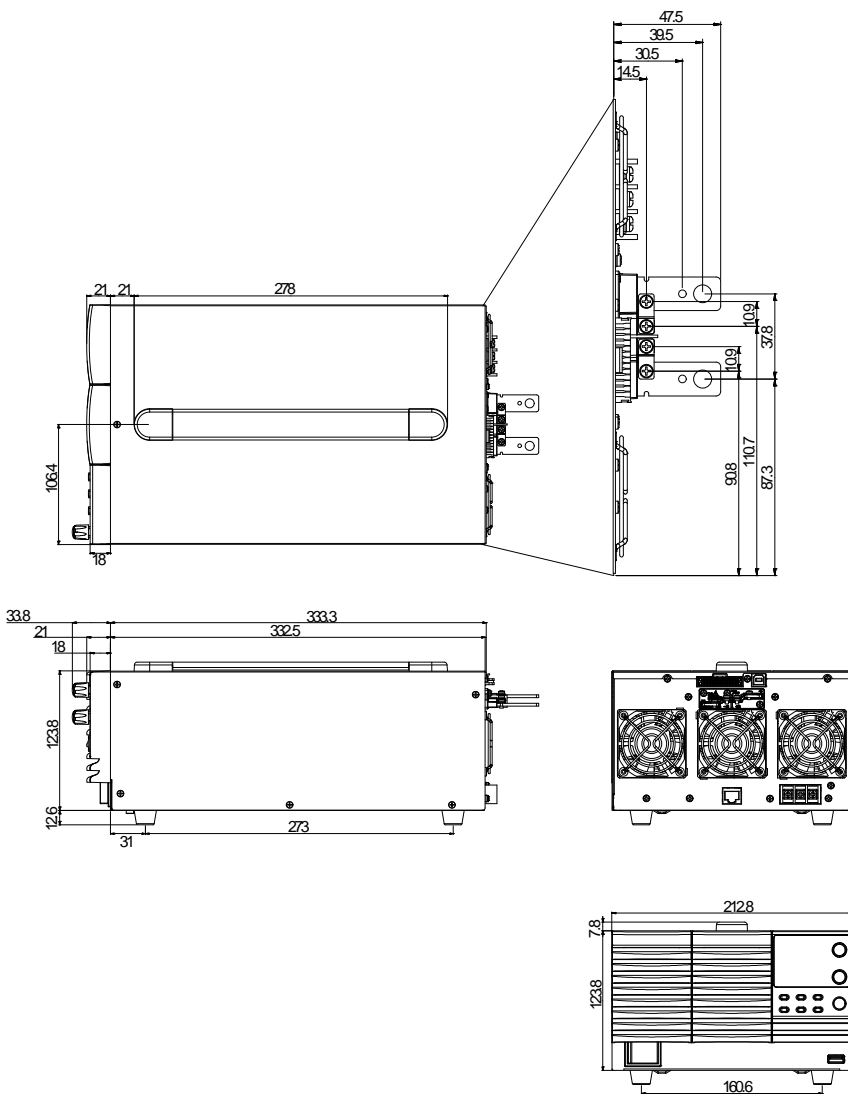

PSW-1080M250/PSW-1080H800 (scale: mm)

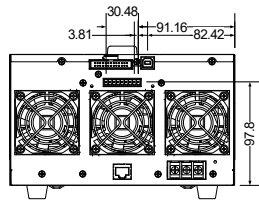
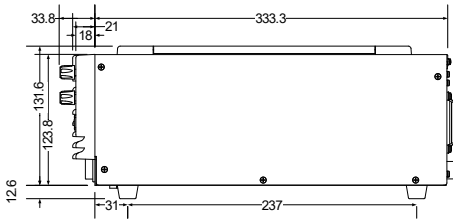
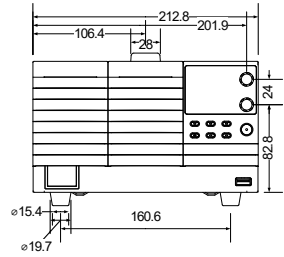
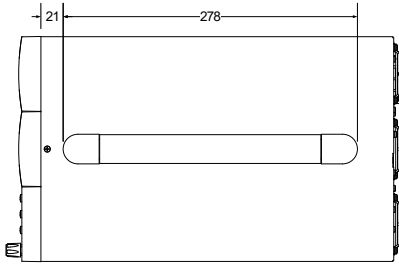



TEXIO TECHNOLOGY CORPORATION

7F Towa Fudosan Shin Yokohama Bldg.
2-18-13, Shin Yokohama, Kohoku-ku, Yokohama, Kanagawa, 222-0033 Japan
<https://www.texio.co.jp/>

